

# ***SAN DIEGO FIRE-RESCUE DEPARTMENT***



## ***RT-130 WILDLAND REFRESHER***

**TRAINING AND EDUCATION DIVISION**

Updated April 2023



# TABLE OF CONTENTS

SUBJECT	PAGE
<b>Introduction</b> .....	<b>1</b>
<b>Company Level Training</b> .....	<b>2</b>
- Wildland Refresher Guide .....	4
<b>Battalion Level Training</b> .....	<b>6</b>
- Question and Answer Assessment .....	8
<b>Safety</b> .....	<b>9</b>
- Predictive Services Seasonal Outlook .....	10
- Fire Potential Index .....	13
- Haines Index .....	15
- LCES .....	16
- 10 Standard Fire Orders .....	18
- 18 Watch Out Situations .....	18
- 5 Common Denominators .....	19
- Incident Response Pocket Guide (IRPG).....	20
- Engine and Vehicle Operations.....	21
<b>VHF King Radio</b> .....	<b>22</b>
- GPH Commander Operating Instructions .....	23
- KNG M-150 VHF Mobile Radio .....	24
- Kenwood TK-790 VHF Mobile Radio .....	27
- Fleet Map .....	36
- Key Review Points for Radio Use .....	38
- Repeater Information .....	39
<b>Wildland Fire Size-Up</b> .....	<b>41</b>
- Initial Response Assignments .....	42
<b>Wildland Air Operations</b> .....	<b>43</b>
<b>Structure Defense S-FACTS and Triage</b> .....	<b>46</b>
<b>Strike Team Metro Zone Code of Conduct</b> .....	<b>50</b>
- Personal Strike Team Bag .....	51
<b>I-Zone Pack</b> .....	<b>52</b>
<b>Handline Construction</b> .....	<b>54</b>
<b>Fire Shelter Survival</b> .....	<b>56</b>
<b>Wildland Abbreviated Guide</b> .....	<b>61</b>
<b>Abbreviated Guide to Incident Command</b> .....	<b>67</b>



# INTRODUCTION

## OVERVIEW:

### Company Level Training

Wildland Refresher training will initially be conducted at the company level by the company officer. All objectives listed under Company Level Training will be documented by the company officer in Target Solutions.

Target Solutions documentation will include a compliance statement to be checked by the company officer, verifying compliance for all assigned personnel.

### Battalion Level Training

Battalion chiefs will then follow-up with Battalion Level Training that will evaluate:

- a. Wildland company level training
- b. Wildland progressive hoselay
- c. Fire shelter deployment

An after-action review will be conducted to reinforce learning and self-identify corrective actions for improvement.

## REFERENCES:

Wildland Refresher Manual

SDFD Drill Manual, Section 13, Wildland

Company Officer's Guide (COG)

SDFD Operations Manual, S.I. 01, Section VIII, Vegetation Fire Procedures

**SAN DIEGO FIRE-RESCUE  
DEPARTMENT  
RT-130 Wildland Refresher**

---

**COMPANY LEVEL TRAINING**

---

TASK: Study, review and practice all objectives listed below prior to Battalion Level Training.

1. WILDLAND REFRESHER GUIDE: Complete all the training listed and be prepared to discuss each of the following:
  - L.C.E.S.
  - 10 Standard Fire Orders.
  - 18 Watch-Out Situations.
  - Engine and Vehicle Operations
2. RESPONSE ASSIGNMENTS: Review the Initial Response Assignments for vegetation fires. (Training Packet, Initial Response Assignments attachment)
3. VHF RADIO: Given a radio dispatch to a wildland fire incident using VHF radio channels, demonstrate how to effectively program a portable King radio (GPH and GPH Commander) to the assigned group/channels, select the tone, setup a scan list, and communicate utilizing clear-text. Be prepared to demonstrate and explain the operation of:
  - Group and Tone Selection
  - Differences between command and tactical frequencies
  - Channel Guard
  - Command Group setup and use
  - Travel Net
4. SIZE-UP: Given a scenario of a vegetation fire, company officers and engineers will be able to perform an effective size-up and give a brief radio report on the assigned channel.
5. WILDLAND AIR OPERATIONS: Review the Wildland Air Operations information for available air resources, their capacities, and communications.
6. STRUCTURE DEFENSE GUIDELINES: Review S-FACTS guidelines for the development of a safe and aggressive plan to defend structures

7. FIRE SHELTERS: Practice and be prepared to demonstrate the rapid deployment of the fire shelter in windy conditions within 30 seconds. Review Fire Shelter Survival. Be prepared to demonstrate proficiency in the following:
  - Identify the proper inspection and care of fire shelters
  - Identify the proper donning of web gear with a fire shelter
  - Identify the characteristics of an effective deployment site
  - Describe the conditions when a fire shelter should be deployed
  - Describe your initial actions when ordered to deploy your fire shelter
  - Identify what items should not be brought into a fire shelter
  - Identify how water would best serve you inside a fire shelter
  - Demonstrate one of the four proper methods of deploying a fire shelter within 30 seconds
  - Remain in the fire shelter for a few minutes to determine any claustrophobic issues
8. I-ZONE PACK. Review and practice the smooth deployment and repackaging of the I-Zone pack. Minimize the time it takes to add an additional hose. Ensure proper placement of the water thief.
9. STRIKE TEAM BAG: Assess firefighter readiness for deployment by inventorying their strike team bag and providing direction/recommendations.
10. STRIKE TEAM / TASK FORCE EXPECTATIONS: Review the Strike Team/Task Force Code of Conduct and describe the roles, behavior, and performance expectations of personnel while on a strike team or task force.

DOCUMENTATION: Once completed, the company officer shall document the training into Target Solutions. A verification statement will be included, which the company officer will use to document compliance of all assigned personnel.

## **RT-130 WILDLAND REFRESHER GUIDE**

1. Briefly identify and discuss the three factors affecting fire behavior.
  - Fuel SDFD Drill Manual, pgs. 13-12 to 13-14
  - Weather SDFD Drill Manual, pgs. 13-3 to 13-8
  - Topography SDFD Drill Manual, pgs. 13-15 to 13-17
2. Discuss the local wind patterns found in the San Diego area and Southern California region.
  - Diurnal SDFD Drill Manual, pgs. 13-4 to 13-6
  - Gradient SDFD Drill Manual, pgs. 13-6 to 13-7
  - Foehn SDFD Drill Manual, pg. 13-6
3. Discuss topography, slope and aspect and how they affect fire speed, spread and methods of fire attack.
  - SDFD Drill Manual, pgs. 13-15 to 13-16
  - Campbell Prediction System
  - Fire Potential Index SDFD Drill Manual, pgs. 13-9 to 13-11
4. Describe the three different fuel loads and the fire dangers associated with each.
  - Light SDFD Drill Manual, pgs. 13-12 to 13-13
  - Medium
  - Heavy
  - Fuel Loading vs. Fuel Arrangement SDFD Drill Manual, pgs. 13-13 to 13-14
5. Discuss what effect elevation and temperature have upon relative humidity.
  - SDFD Drill Manual, pgs. 13-3 to 13-4, 13-7 to 13-8, 13-17
6. Review LCES, FIRE ORDERS, 18 SITUATIONS THAT SHOUT WATCHOUT and ENGINE AND VEHICLE OPERATIONS.
  - LCES- SDFD Drill Manual, pgs. 13-20 to 13-21, IRPG pg. 7
  - 10's and 18's- IRPG Back Cover
  - Engine/Vehicle Operations- SDFD Drill Manual pg. 13-24 to 13-25
  - SDFD Wildland Refresher, pgs. 14 to 16
7. Describe and give examples of Safety Zones and Temporary Refuge Areas (TRA)
  - SDFD Drill Manual, pgs. 13-21 to 13-22
  - Incident Response Pocket Guide, pg. 8
8. Discuss proper PPE for Wildland Firefighting.
  - Department Chart of Required Personnel Protective Equipment (PPE)
  - SDFD Single-Layer Wildland PPE/Uniform Pant, Office of the Chief #17-040 8/18/2017

## **RT-130 WILDLAND REFRESHER GUIDE**

9. Discuss situations and procedures for fire shelter deployment
  - SDFD Drill Manual, pg. 13-23
  - SDFD Wildland Refresher, pgs. 44-48
  - SDFD Wildland Refresher, NFES 2710, New Generation Fire Shelter
  
10. Review and practice the four methods of deploying a fire shelter (within 30 seconds)
  - Standing Deployment
  - On the Ground Deployment
  - While Engaging
  - Strong Wind Deployment
  
11. Discuss considerations and guidelines associated with wildland firefighting structure defense procedures.
  - SDFD Wildland Refresher, pgs. 37-38
  - SDFD Drill Manual pgs. 13-30 to 13-33
  
12. Review and practice urban interface hose lays utilizing the I-Zone Pack, incorporating the SDFD Mattydale.
  - SDFD Training Bulletin #03-04 – Cleveland (Ponderosa) Hose Pack
  - SDFD Wildland Refresher, pg.42-43
  
13. Discuss the roles, behavior and performance expectations of personnel while on Strike Team/Task Force deployments.
  - SDFD Drill Manual, pg. 13-41 to 13-43
  - Metro Zone Strike Team Code of Conduct
  
14. Review and practice VHF King Radio procedures.
  - SDFD Wildland Refresher, pg. 14
  - SDFD “S” Drive, Radio Training
  
15. Review all SDFD communications relating to wildland firefighting during the preceding 12 months.
  - Refer to current year’s Wildland Refresher Packet distributed with bulletin.

# SAN DIEGO FIRE-RESCUE DEPARTMENT

## RT-130 Wildland Refresher

---

### BATTALION LEVEL TRAINING

---

This manipulative drill is designed for a multi-company setting. This drill will identify the effectiveness of the preparation at the company level, the weaknesses that require additional emphasis, and the effectiveness of the crew. The after-action review will reinforce learning and self-identify corrective actions for improvement.

Equipment Needed: Fire engine, I-Zone pack, practice fire shelters, two (2) blowers and 800 MHz and VHF radios.

The preferred drill site will be in your district where you can extend a progressive hose lay into the interface. Suggested format is as follows:

1. QUESTION/ANSWER ASSESSMENT - Using the suggested question topics (attached), assess the effectiveness of the company level training of the listed topics.
2. MANIPULATIVE DRILL – Conduct a manipulative drill which includes a progressive hoselay utilizing the I-Zone Pack using the following scenario or a similar one of your choice. Direct that one escape route lead to where blowers will be setup for fire shelter deployment. Near completion, or to your satisfaction, of the progressive hoselay, provide information to assigned lookout person of Scenario Update-1 below. Crews should run to the designated safety zone (where blowers are setup and operational to simulate the turbulent high winds of a running fire); dropping their packs and fuses, keeping tools needed for prepping their deployment area, and pulling out their fire shelter while running; then deploy their fire shelter in front of blowers to simulate high wind fire conditions. After deployment, initiate Scenario Update-2 and identify one firefighter extremely burned and requiring immediate transport.
  - SCENARIO: You are assigned to a strike team that has been directed to extinguish a section of a large brush fire in light and medium fuel. It is hot and dry with unstable weather conditions. Your direct view of the main fire is compromised by small hills surrounding your area of operation.

#### ***REQUIRED ACTIONS:***

- a. IC gives quick safety brief to crews covering LCES.***
  - b. Escape routes and a safety zone are identified.***
  - c. IC assigns a person as Lookout***
  - d. Crews initiate a progressive hose lay***
- SCENARIO UPDATE-1: Lookout sees and receives reports that the main fire has turned towards the crew and is quickly approaching with high winds and 100 foot flame lengths with spotting reported by adjacent strike teams.



***REQUIRED ACTIONS:***

- a. Lookout communicates danger***
- b. IC directs shelter deployment in the deployment zone selected***
- c. Crews shed fuses and other unnecessary items while running***
- d. Crews keep tools for site prep and pull out shelter while running***
- e. All deploy shelter to standards***
  - Feet towards fire***
  - Within 30 seconds***

- **SCENARIO UPDATE-2:** Everyone notices a decrease in noise and wind conditions. The color of light passing through your shelter has lessened. Temperature has cooled significantly. Supervisor communicates to crew that it is safe to exit. After exiting shelter, a firefighter is found with burn injuries and unable to walk. Crew is too far out to carry the injured firefighter.

***REQUIRED ACTIONS:***

- a. Exit shelter***
- b. Assess status of all crew members.***
- c. Leader notifies Supervisor of shelter deployment, crew status and injuries***
- d. Leader requests air evacuation of injured firefighter***

3. **AFTER-ACTION REVIEW:** Ask the following questions and let the crews self-identify what actually happened and how it should have happened. Guide the answers to the proper procedures.

**a. What was planned?**

- Review the primary objectives and expected action plan.

**b. What actually happened?**

- Review the day's actions:
- Identify and discuss effective and non-effective performance.
- Identify barriers that were encountered and how they were handled.
- Discuss all actions that were not standard operating procedure, or those that presented safety problems.

**c. Why did it happen?**

- Discuss the reasons for ineffective or unsafe performance. Concentrate on what, not who, is right.

**d. What can we do next time or to prepare for next time?**

- Determine lessons learned and how to apply them in the future.

**DOCUMENTATION:** Once completed the battalion chief shall document the training in Target Solutions. A verification statement will be included in the training tab, which the battalion chief will use to document compliance of all assigned personnel.

# QUESTION AND ANSWER ASSESSMENT

---

## **Instructions:**

Battalion Chiefs should use this as a guide as they conduct ***Battalion Level*** Wildland Refresher drills. The BC should facilitate Question and Answer sessions reviewing the listed topics, prior to conducting a wildland manipulative drill which incorporates a fire shelter deployment.

## **Suggested Question Topics:**

1. LCES
2. 10 Standard Fire Orders
3. 18 Situations That Shout Watch Out
4. Do's and Don'ts of Engine/Vehicle Operation
5. Vegetation Alarm Assignments
6. VHF Radio Procedures
  - Give a radio assignment and have all crewmembers program their radio
  - When is Travel Net used?
  - When should Channel Guard not be used, and why?
7. Considerations for a Vegetation Fire Size-Up
8. Discuss the consideration and procedures when assigned Structure Protection
9. Personal Strike Team Bag contents and readiness
10. Fire shelter deployment:
  - How long should it take to deploy a shelter? (***15-20 sec***)
  - Can you be running while deploying your shelter? (***Yes***)
  - What signs signify when you can exit your shelter? (***A decrease in noise, wind, heat and a change in color of light passing through the shelter...when your supervisor tells you it is safe to exit***)
  - When should you inspect your shelter? (***First issue and every first day back***)
  - What is the most common damage to fire shelters? (***Abrasion***)
  - If you must get into someone else's shelter as a last resort, what must do? (***Yell at them to let them know you are entering***)
  - What is the best way to use water in an entrapment? (***Drink it, don't wet yourself down***)

Can you transmit and be heard using your VHF or 800 MHz radio while in the shelter? (***Not really; VHF can for nearly 50ft only and the 800MHz cannot, so communicate before entering or after exiting the shelter***)

# **WILDLAND SAFETY**

**SOCAL SEASONAL OUTLOOK 2023**

**FIRE POTENTIAL INDEX**

**LCES**

**10 STANDARD FIRE ORDERS**

**18 WATCH OUT SITUATIONS**

**5 COMMON DENOMINATORS**

**ENGINE and VEHICLE OPERATIONS**



### 4-Month Significant Fire Potential:

**April – May 2023**

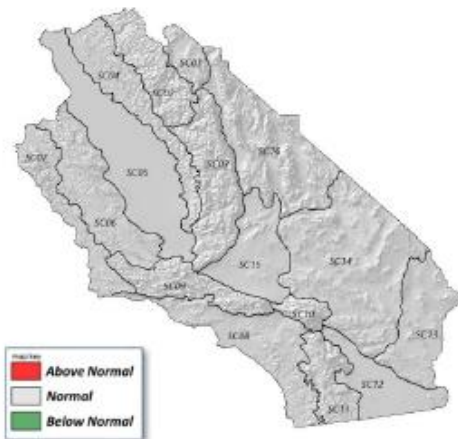

**June 2023**

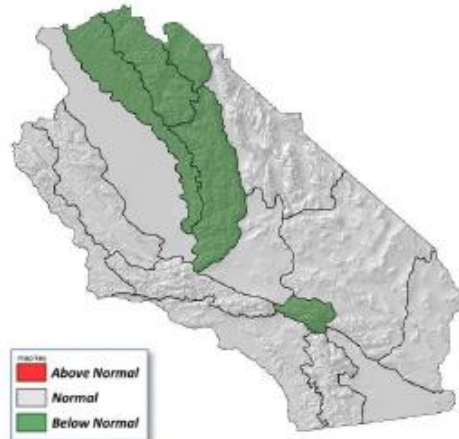

**July 2023**

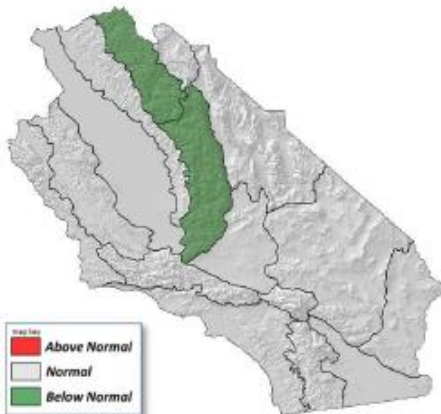

#### April – July 2023 Highlights:

- Current ENSO index is near neutral and an El Niño may form by the fall.
- Temperatures will likely average near normal near the coast with daytime temperatures possibly above normal further inland.
- Near to below normal number of offshore wind events this spring.
- Near normal large fire potential next few months. An above normal amount IA may occur in May and June once the current grass crop cures.
- Large fire potential will be below normal in the upper regions of the mountains. Very low potential above 8,000' this spring/summer





**Weather Discussion**

A favorable long wave pattern allowed several Atmospheric River (AR) storm systems to reach the state in March. These storms, aided by a strong jet stream and favorable low level flow, unleashed heavy rain, hail, strong winds and even a few tornadoes this past month.

Rainfall in March was over 400% of normal in many locations. The greatest departure from normal occurred over Central CA which saw the heaviest rainfall due to orographic lift. The subtropical origins of the moisture resulted in some very high snow levels with many areas in the Sierra seeing rainfall up to 9,000' from one particularly wet storm system. Only the deserts eastward to the Colorado River saw average to below average precipitation last month.

The hydrological condition across California continues to improve markedly. The widespread nature of the precipitation across many of the state's most important watersheds has resulted in groundwater recharge in the San Joaquin Valley. Reservoir storage levels continue to climb quickly as well. Some Northern California dams have let some water discharge from their reservoirs which is a sharp contrast to the near record low levels seen prior to the start of the rainy season.

Typically, a negative ENSO condition results in a greater chance of a drier than average winter, especially in Southern CA. But even though this is the 3<sup>rd</sup> consecutive winter of a La Niña, this has obviously not been the case this year. A potential cause of the high frequency of the storms this season may be attributed to an unusually strong jet stream which has been present much of the winter. This has allowed the storms to intensify rapidly before moving ashore as well as allow already existing storms to "break through" the eastern Pacific ridge.

This jet will undoubtedly weaken as winter gives way to spring, but until then, the potential for additional wetting rains may continue for a few more weeks. Rainfall should begin to wane by the middle or latter half of April, which is several weeks later than usual.

Fig 1: March 2023 Departure from Av. Temp.



Fig 2: Oct. 2022 – Mar. 28, 2023 Precip. (% of Ave.)



Fig 3: Basin Av. % Snow water equiv, (SWE), Mar. 28, 2023

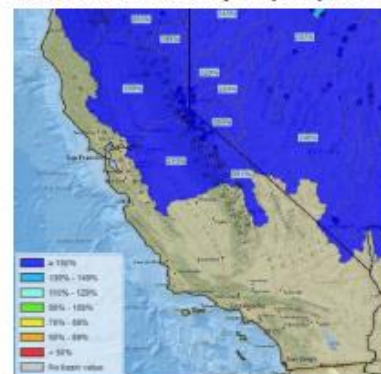



**SOUTH OPS OUTLOOK**

The sudden warming of sea surface temperatures (SST) over Niño Regions 1+2, 3 and 3.4 have resulted in the dissolution of the La Niña which had previously shown unprecedented staying power. Except for a brief break in the summer of 2021, a negative ENSO index (-0.5°C or greater) has continued since July 2020. This may not have a direct impact on this summer’s weather, but a reversal to an El Niño condition may have implications on the weather this fall or next winter.

Most long term model guidance, including the NMME and the NCEP CFSv2, is depicting near to slightly above normal temperatures the next 4 months with the greatest departure from normal likely occurring across inland areas. Precipitation in May – July is expected to be near normal. A slightly above normal monsoon season may occur over the Southwest, but persistent troughing off the coast may keep the moisture axis shifted well to our east. A repeat of last years extremely wet monsoon is not expected and the number of thunderstorm days should be near normal in June/July.

A heavier than normal grass crop does raise the specter of a higher than normal number of grass fires once grasses cure out in May. However, the last 20 years have not shown a strong correlation between a wet winter (with an assumedly heavier than normal grass crop) and a busy “grass fire season.” There may be an increase in starts and initial attack due to the high availability of fine dead fuels, but without strong winds, such fires have an excellent chance of being picked up by local resources, or during one or two daytime burn periods. Offshore wind events are expected to be near or below normal this spring which would likely lead to fewer opportunities for grass fires to spread rapidly or into other fuel types.

Higher elevations will likely see a significant delay to normal fire potential due to heavy snowpack above 6,000 feet. Once meltout occurs in lower elevations, fire potential will climb to near normal levels by July. Higher elevations in the Sierras may not see much fire potential this summer. In 2011, fires tended to show much less activity above 8,500 feet which may also be the case this season.

The end of this winter’s rainy season brings a conclusion to a very unusual period of stormy weather in California. Since July 2022, the Geographic Area has seen numerous wet thunderstorms with flooding in the desert, snow as low as 1,000 feet, an EF2 tornado and even 100 mph winds courtesy of Hurricane Kay. It is safe to assume the next several months will hold far less weather drama than what occurred the past 9 months.

Fig 6: Dominant weather pattern this spring/summer?

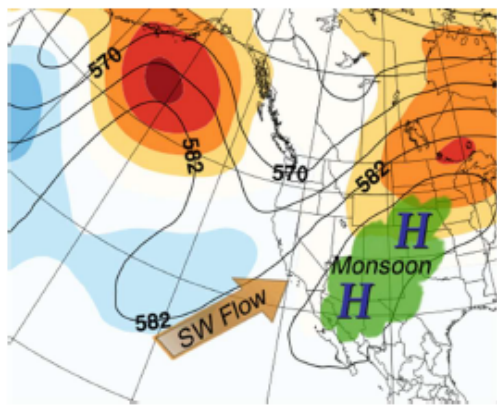
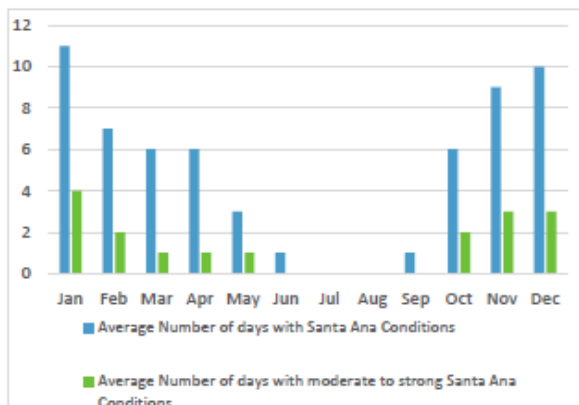

Fig 7: Number of Santa Ana events per month





# SDG&E FIRE POTENTIAL INDEX (FPI)

Since 2016, SDFD adopted the use of the SDG&E's Wildfire Potential Index, replacing the previously used Burn Index. The FPI attempts to use the real time environmental data to assess the potential for large, damaging fires, projecting values for not only the current day, but for the subsequent seven-day period. It is a planning and decision support tool used to quantify the fire potential utilizing state-of-the-art technology that accounts for weather, live fuel moisture, dead fuel moisture, and the greenness of the annual grasses. The FPI is announced daily on the station overhead tones and paged to personnel by ECDC at 0800 hours.

There are eight operating districts in total, and SDFD's jurisdiction includes three of them- Northeast (NE), Beach Cities (BC), and Construction Metro (CM). Each of the eight individual operating districts have their own index, utilizing a scale with values ranging between 0 and 17. These values are divided into three adjective descriptors: **Normal 0-11 (Green)**, **Elevated 12-14 (Yellow)**, and **Extreme 15-17 (Red)**. These values were established to indicate damage potential to property. "Normal" FPI levels denote a nearly non-existent threat from damaging fire. "Elevated" levels have shown rare and little damage of property in the occurrence of wildfire. "Extreme" FPI levels are indicative of a likelihood of damage due to wildfire.

The data used to generate of the FPI index suggests that the likelihood of a large wildfire occurring is likely only during periods of severe weather, which includes elements of strong winds, low relative humidity values, and critically dry vegetation. These are key elements in rating San Diego County on the Santa Ana Wildfire Threat Index, which is also illustrated in the "7-Day FPI Outlook" emails issued frequently through the department's email communications. The website to view the Fire Potential Index can be found at <http://fpi.sdgeweather.com/>.

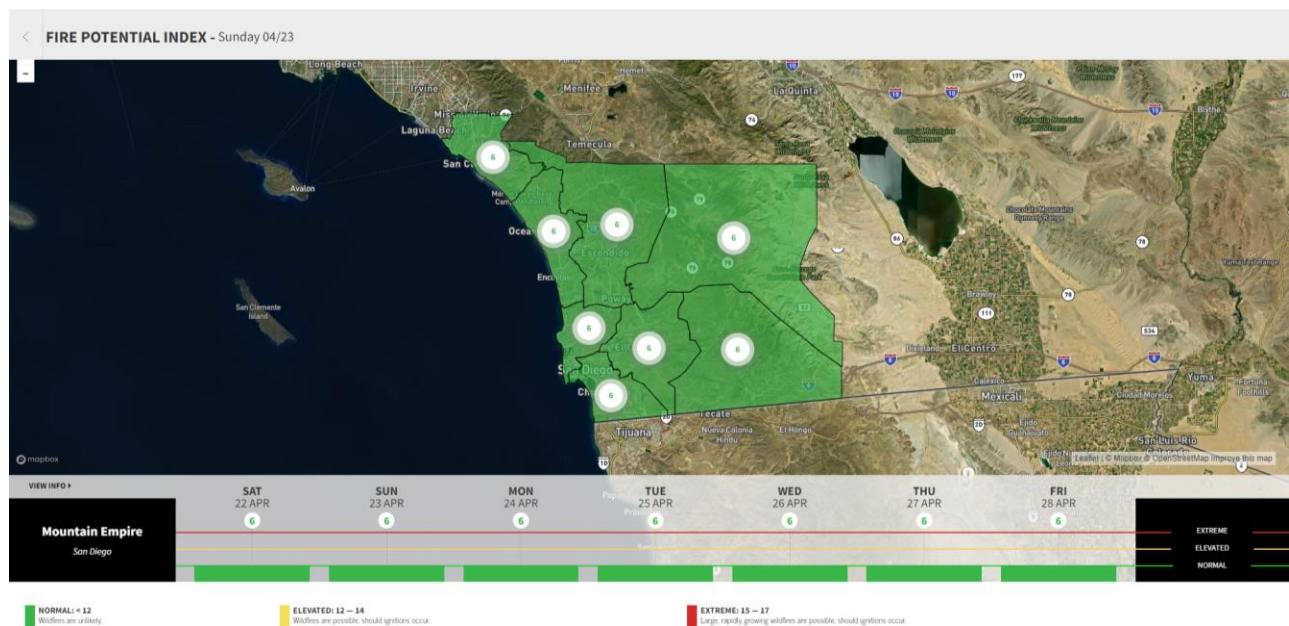

**Seven Day FPI Outlook:**

	Tue 11/13	Wed 11/14	Thu 11/15	Fri 11/16	Sat 11/17	Sun 11/18	Mon 11/19	Tue 11/20
ME	Extreme 16	Extreme 15	Elevated 14	Elevated 14	Elevated 13	Elevated 13	Elevated 13	Elevated 12
RA	Extreme 16	Extreme 15	Elevated 14	Elevated 14	Elevated 13	Elevated 13	Elevated 13	Elevated 12
EA	Extreme 16	Extreme 15	Elevated 14	Elevated 13	Elevated 13	Elevated 12	Elevated 12	Elevated 12
NE	Extreme 16	Extreme 15	Elevated 14	Elevated 13	Elevated 13	Elevated 12	Elevated 12	Elevated 12
OC	Extreme 15	Elevated 14	Elevated 14	Elevated 13	Elevated 12	Elevated 12	Normal 11	Normal 11
NC	Extreme 15	Elevated 14	Elevated 13	Elevated 13	Elevated 12	Normal 11	Normal 11	Normal 11
BC	Extreme 15	Elevated 14	Elevated 13	Elevated 13	Elevated 12	Normal 11	Normal 11	Normal 11
CM	Elevated 14	Elevated 14	Elevated 13	Elevated 13	Elevated 12	Normal 11	Normal 11	Normal 11



**Santa Ana Wildfire Threat Index for San Diego County:**

Tue 11/13	Wed 11/14	Thu 11/15	Fri 11/16	Sat 11/17	Sun 11/18
High	Moderate	No Rating	No Rating	No Rating	No Rating

No-Rating	Marginal	Moderate	High	Extreme
Santa Ana winds are not expected or will not contribute to significant fire activity.	Upon ignition, fires <i>may</i> grow rapidly.	Upon ignition, fires <i>will</i> grow rapidly and <i>will</i> be difficult to control.	Upon ignition, fires will grow <i>very</i> rapidly and will be <i>very</i> difficult to control.	Upon ignition, fires will have extreme growth and will be uncontrollable.



## HAINES INDEX

Haines (1988) developed the Lower Atmosphere Stability Index, or Haines Index, for fire weather use. It is used to indicate the potential for wildfire growth by measuring the stability and dryness of the air over a fire. It is calculated by combining the stability and moisture content of the lower atmosphere into a number that correlates well with large fire growth. The stability term is determined by the temperature difference between two atmospheric layers; the moisture term is determined by the temperature and dew point difference. This index has been shown to be correlated with large fire growth on initiating and existing fires where surface winds do not dominate fire behavior. The Haines Index can range between 2 and 6. The drier and more unstable the lower atmosphere is, the higher the index.

Index	Fire's Growth Potential
2	Very Low Potential (Moist and Stable in the Lower Atmosphere)
3	Very Low Potential
4	Low Potential
5	Moderate Potential
6	High Potential (Dry and Unstable Lower Atmosphere)

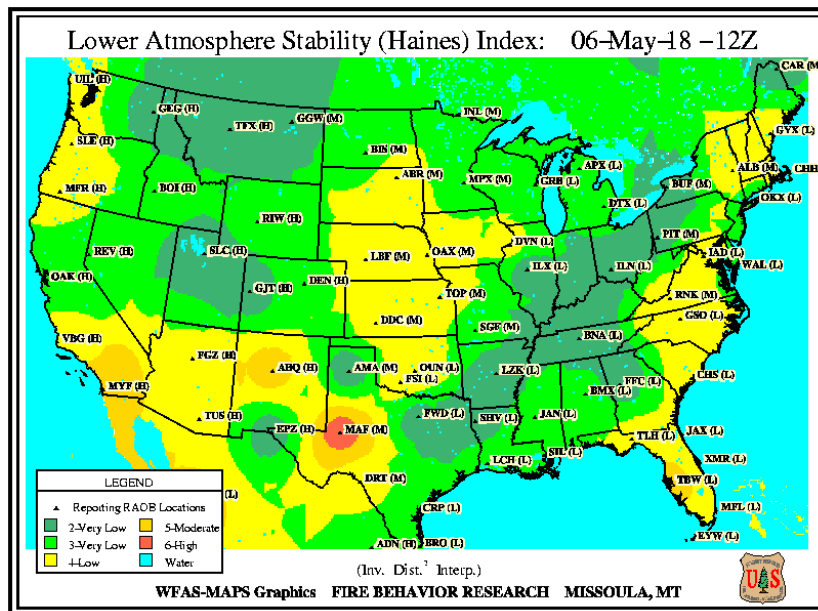

The Haines Index can be found online at the U.S. Forest Service (USFS) Wildland Fire Assessment System's homepage <https://www.wfas.net/index.php/haines-index-fire-potential--danger-34>. Included on this homepage is a national map, indicating the index values across the nation. Information about the Haines Index can also be conveniently referenced in the Incident Response Pocket Guide (IRPG) under the white pages. Pay attention to the Haines Index value for the operational shift which you are working when briefed by your company officer, and before engaging in fire suppression operations. It will be a key indicator in understanding what type of fire behavior to expect when working on your assigned area of the fire.

---

## **L.C.E.S.**

---

All personnel have the obligation to ensure LCES has been established prior to engaging in any fire suppression operations. If any element of LCES that has not been established, the planned operation will be considered a no-go situation until that element has been identified. It is crucial that ALL FIREFIGHTERS take responsibility for updating their situational awareness and LCES throughout the course of the operation. All firefighters should have knowledge and access to safety zones at all times when operating in a hazardous environment.

### **Lookouts**

1. Have adequate knowledge of fuels, weather, topography, and fire behavior.
2. Are experienced, competent, and trusted individuals.
3. Observe from a safe location with an expansive vantage point of all hazards and personnel locations.
4. Have an understanding of the escape route and safety zone location(s).
5. Have a knowledge of pre-established trigger points.
6. Have uninhibited communication with assigned units and know their locations and identifiers.

### **Communications**

1. All personnel shall know the communication plan for the incident.
2. All supervisory personnel shall insure direct communication with their subordinates, superiors, and adjacent resources at all times. Effective communications may include the use of radios, face-to-face, phones, visual signals, and mechanical devices.
3. All personnel shall demonstrate discipline when utilizing radios by communicating only when necessary through short, precise, and complete messages utilizing clear-text.
4. All personnel shall insure that communication is received and understood. Do not assume. Repeat the message back to ensure your understanding.
5. All personnel shall perform periodic radio checks as necessary.
6. Provide updates to personnel as situations change. Do not hesitate.

### **Escape Routes**

1. When possible, have more than one escape route accessible to personnel while operating in a hazardous environment.
2. Escape routes shall be scouted (visually checked) for loose soil, rocks, vegetation and any other barriers that may slow the escape time or make escape difficult.
3. Escape routes shall be timed considering the slowest person, fatigue, weather, and fire behavior factors.
4. Evaluate escape time vs. rate of spread.
5. Mark escape routes with flagging. This will ensure all personnel escape in the proper direction and can be useful for other crews working in that area during subsequent operations.
6. Escape routes (and Survival Zones) may change over time; reassess periodically for viability.
7. Park vehicles backed into place and pointed towards the direction of escape.

## Safety Zones

1. Safety Zones are locations where firefighters can survive without deploying a fire shelter. Examples of safety zones include natural features (rock out-croppings, water bodies, meadows, etc.) and man-made features (vegetation clear-cuts, roads/highways, helispots, dozer clearings, parking lots, etc.). The most ideal safety zone is in the clean burn, which is free of any re-burn potential.
2. Safety Zones shall be adequate in size for all personnel and apparatus, with a separation distance between the firefighter and the flames being equal to or exceeding **4x the maximum flame height**. Distance separation refers to the radius from the center of the safety zone to the nearest available fuels.
3. The escape time and safety zone requirements will change as fire behavior changes and as suppression operations progress. Constantly reassess if escape routes and safety zones are adequate. If they aren't, disengage and reestablish adequacy.

Flame Height	Separation Distance	Area in Acres*
10 feet	40 feet	1/10 acres
20 feet	80 feet	½ acres
50 feet	200 feet	3 acres
100 feet	400 feet	12 acres
200 feet	800 feet	46 acres

\*Area in acres is calculated to allow for distance separation on all sides for a 3-person engine crew. Consider that 1 acre is approximately equal to the size of 1 football field, or 208 feet x 208 feet.

\* Area calculations are based on RADIANT heat only, and do not account for convective heat from wind and/or terrain influences. Safety zones downwind or upslope from the fire may require larger separation distances as calculations assume no wind and no slope.

---

## **10 STANDARD FIREFIGHTING ORDERS**

---

1. Keep informed on fire weather conditions and forecasts.
2. Know what your fire is doing at all times.
3. Base all actions on current and expected behavior of the fire.
4. Identify escape routes and safety zones and make them known.
5. Post lookouts when there is possible danger.
6. Be alert. Keep calm. Think clearly. Act decisively.
7. Maintain prompt communications with your forces, your supervisor, and adjoining forces.
8. Give clear instructions and insure they are understood.
9. Maintain control of your forces at all times.
10. Fight fire aggressively, having provided for safety first.

---

## **18 WATCHOUT SITUATIONS**

---

1. Fire not scouted and sized up.
2. In country not seen in daylight.
3. Safety zones and escape routes not identified.
4. Unfamiliar with weather and local factors influencing fire behavior.
5. Uninformed on strategy, tactics, and hazards.
6. Instructions and assignments not clear.
7. No communication link with crewmembers/supervisors.
8. Constructing line without safe anchor point.
9. Building fireline downhill with fire below.
10. Attempting frontal assault on fire.
11. Unburned fuel between you and the fire.
12. Cannot see main fire, not in contact with anyone who can.
13. On a hillside where rolling material can ignite fuel below.
14. Weather is getting hotter and drier.
15. Wind increases and/or changes direction.
16. Getting frequent spot fires across line.
17. Terrain and fuels make escape to safety zones difficult.
18. Taking a nap near the fireline.

---

## 5 COMMON DENOMINATORS OF FIRE BEHAVIOR ON TRAGEDY FIRES

---

Case studies have shown that there are several common fire behavior characteristics that have resulted in firefighter fatalities and near misses. These characteristics are called the common denominators of fire behavior on tragedy fires. These common denominators stress that you must remain alert for potentially life-threatening situations, even when the fire does not appear to be dangerous. Keep up with your Situational Awareness regarding the current and expected behavior of the fire on your incident, the physical geography of the land you are working on, the condition of the fuels, and the weather dynamics forecasted for the incident area. Maintaining these elements of situational awareness will aid in sustaining a successful and safe operation.

There are five major common denominators of fire behavior on fatal and near-fatal fires. Such fires often occur:

1. On relatively small fires, or deceptively quiet areas of large fires.
2. In relatively light fuels such as grass, herbs, and light brush.
3. When there is an unexpected shift in wind direction or wind speed.
4. When fire responds to topographic conditions and runs uphill.
5. Critical burn period between 1400 and 1700.

**Alignment of topography and wind during the Burning Period should be considered a trigger point to re-evaluate tactics. Blowup and burn over conditions generally occur in less than 60 minutes and can be as little as 5 minutes. A tactical pause may be prudent around 1400 for reevaluating your situational awareness of topography, weather, and fuel.**

---

# INCIDENT RESPONSE POCKET GUIDE (IRPG)

---

The intent of the IRPG is to provide a wildland fire job aid and training reference for ALL operational personnel, ranging from Firefighter to Division Supervisor to Initial Attack/Extended Attack Incident Commanders. It also has a secondary application for all-hazard incident response. Some fireline decisions may not be relatively simple, and many are not. These decisions often require individual judgement and creativity- skills developed through extensive training, dedicated practice, and experience. The IRPG provides a collection of best practices that have evolved over time within the wildland fire service. It does not provide absolute solutions to the unlimited number of situations that will occur.

The IRPG is a small reference guide that easily fits in your pocket. It contains five color-coded sections that focuses primarily on the tactical issues of firefighting.



1. **Green Section-** OPERATIONAL GUIDELINES. Examples include:
  - Risk Management
  - Situational Awareness
  - 5 Common Denominators
  - LCES
  - Safety Zones
  - Wildland-Urban Interface Firefighter
2. **Gray Section-** SPECIFIC HAZARDS. Examples include:
  - How to Properly Refuse Risk
  - Thunderstorm Safety
  - Hazard Tree Safety
  - Powerline Safety
  - Last Resort Survival
3. **Yellow Section-** ALL-HAZARD RESPONSE. Examples include:
  - Vehicle Accident Response
  - Hazmat Ops, Isolation Distances, and Classification
  - Local Disaster Response
  - All-Hazard Incident Response
4. **Blue Section-** AVIATION. Examples include:
  - Aviation Watch-Outs
  - Passenger Briefing Checklist and PPE
  - Helicopter Landing Area Selection
  - Helispot Information
  - Aerial Retardant Safety
  - Directing Retardant and Bucket Drops
  - Working with Air Tankers
5. **White Section-** OTHER REFERENCES. Examples include:
  - Spot Weather Forecast
  - Haines Index
  - Wind Speed Ranges
  - Severe Fire Behavior Potential
  - Direct/Indirect Strategies
  - Media Interviews

---

## ENGINE AND VEHICLE OPERATIONS

---

*The following guidelines apply to all vehicles operating on a Wildland-Urban Interface (WUI) incident. Failure to follow these rules can result in serious firefighter injury, loss to structures, and damage to equipment.*

### DO NOT:

1. **DO NOT** block roadways. Always park so all other equipment can safely get by your vehicle. This may require laying a supply line to allow room for others to pass.
2. **DO NOT** park on mid-slope roads where fire is below your location with unburned fuel between you and the fire.
3. **DO NOT** park in or near chimneys, saddles, or draws. These topographical features will channel heat and smoke and dramatically increase the intensity of fire at your location.
4. **DO NOT** park under power lines or near exposed propane or fuel tanks.

### DO:

1. Park on the opposite side of the road away from the fire and have a protection line charged and in position, if needed.
2. Use natural fire barriers (rocky areas, cut banks, ridges, and noncombustible structures) to your advantage to “shield” your engine from convective and radiant heat.
3. Park engine in a Safety or Survival Zone and pointing in direction of egress. This will assist egress when reassigned to other areas.
4. Use a scout, if necessary, to Recon ahead rather than place your engine in an unsafe position (STL vehicles and patrols work great for Recon).
5. Recon ahead of your engine when driving in unfamiliar areas. Many homes in wildland areas have overhead obstructions and private bridges, leach fields, and underground septic tanks that will not support the weight of an engine.
6. Keep headlights and warnings light on for better visibility.
7. Channel water with a shovel and salvage cover (if necessary) when pumping and leaking water onto an unpaved surface. This will avoid getting your rig stuck and/or destroying the road surface.
8. Use water sparingly; water on wildland fires can be limited. Locate primary and secondary water sources e.g., private tanks, pools, cisterns, lakes, streams, hydrants, etc. Note: Hydrants cannot be considered reliable on most large wildland fires.
9. Place 2 or 3 eductors (when possible) on one engine with a reliable water source, this can dramatically increase your water supply over a single eductor.
10. Shut down the engine, extinguish the fire with a CO2 extinguisher (No water or Dry Chem) and notify your STL or DIVS if the air filter on your engine catches on fire.
11. Lay hose only when absolutely necessary. Laying hose on the ground takes time and energy, reduces flexibility, and may have to be left.
12. Contact your Division or Group Supervisor (or Staging Area Manager if staged) for any needs for your engine. They will relay the message to the Ground Support Unit.

# VHF BENDIX KING RADIO

## OPERATING INSTRUCTIONS

### FLEET MAP

### STONE USE



BK Commander Portable



# Bendix-King GPH Commander (Round Buttons) Operating Instructions

## COMMAND GROUP

The GPH-CMD radio allows construction of a Command Group of up to 20 channels, drawn from any of the programmed channels in the radio. To modify the Command Group (add or delete channels) all scanning functions (Channel Scan, Group Scan, and Priority Scan) must be turned OFF.

### BUILDING A COMMAND GROUP

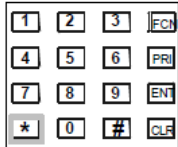

While operating in a group other than the Command Group (group 1 – 25), the user selects a channel in the radio and presses the [\*] key to enter the channel into the Command Group. If a channel is on the scan list in its home group, it will also be on the Command Group's scan list. Unprogrammed channels cannot be added to the Command Group. Up to 20 channels may be entered.

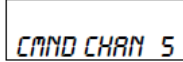

After adding a channel, the display momentarily shows 'CMND CHAN XX' where XX is the channel number (1 – 20). Parameters associated with each selected channel, such as Bandwidth, Scan, and Power settings, are also used while operating in the Command Group.



Once 20 channels are entered, subsequent presses of the [\*] key will cause the radio to beep and momentarily display the message 'CMND FULL'. When operating in the Command Group, the continuously rotating channel selector will "stop" at the highest programmed channel. For example, if only 4 channels are programmed, when the channel selector is rotated past the 4<sup>th</sup> channel the radio will beep and remain on the 4<sup>th</sup> channel.

### OPERATING FROM THE COMMAND GROUP

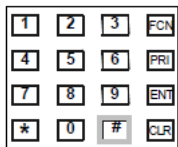

The Command Group can be entered by pressing the [#] key twice. Operation in the Command Group is indicated on the display by the 'CMND' icon.

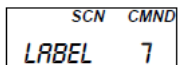

Adding or deleting a channel to/from the Command Group's scan list also changes the channel's status in its home group.

It is not valid for a priority channel to be set to a channel in the Command Group. If, while operating in the Command Group, the [PRI] key is pressed to designate a priority channel, the "target channel" that is pointed to by the Command Group channel will be marked as the priority channel.

### MODIFICATION OF THE COMMAND GROUP

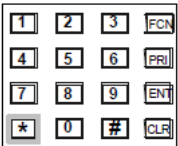

When the Command Group is active, a short press of the [\*] key deletes the knob-selected channel, while a long press (4 seconds) deletes all channels in the Command Group.



When a channel is deleted, the display momentarily shows 'CHAN DELETED', and the following channels move up in the list. For example, if channel 5 is deleted, channel 6 becomes the new channel 5, channel 7 becomes the new channel 6, etc. When all channels are deleted, the radio beeps continuously and the display shows **CMND EMPTY** along with the 'CMND' icon.

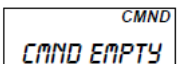

Exit the Command Group to add new channels.

## RADIO CONTROLS

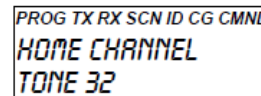
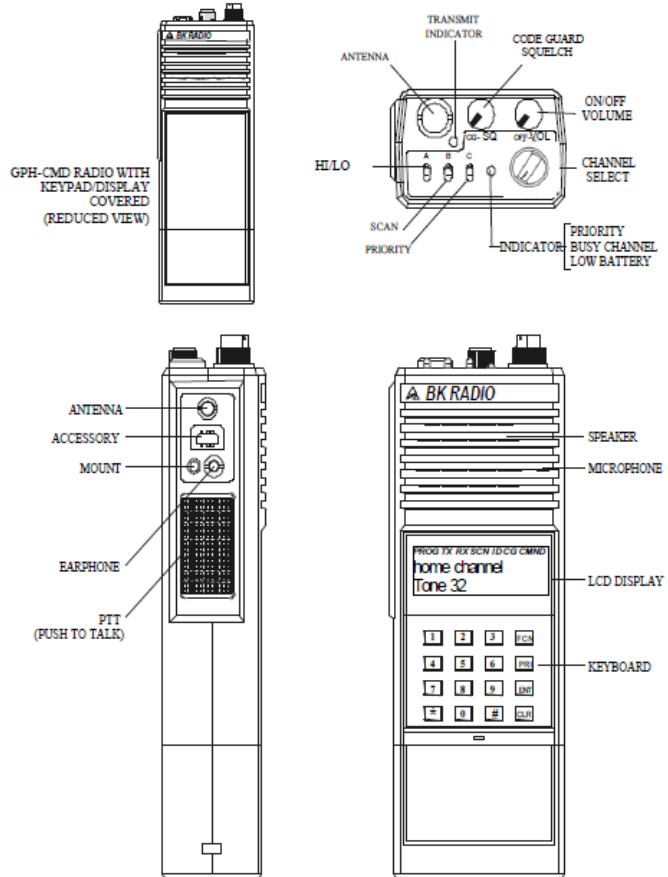

Alphanumeric Display

# KNG M-150 Mobile VHF (NEW) Operating Instructions

## On-Screen Display

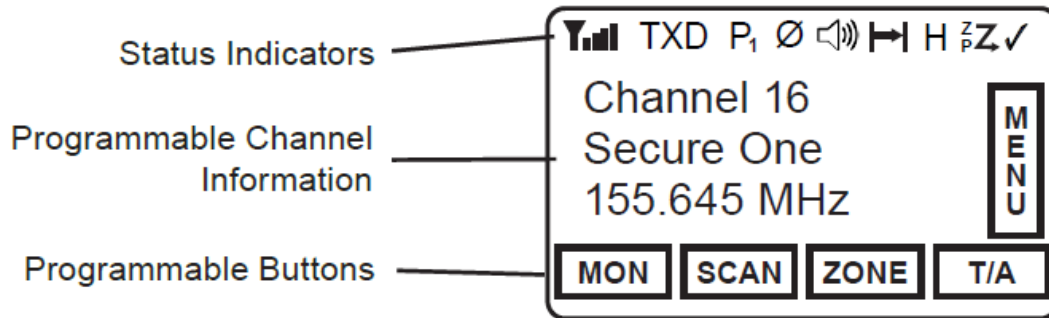

Status Indicators	
	Receiver Signal Strength
RXD, RXA	Receive Digital, Receive Analog, Hold Time Active
TXD, TXA	Transmit Digital, Transmit Analog
H	High Transmit Power
L	Low Transmit Power
P1, P2	Priority 1 Channel, Priority 2 Channel
Ø	Selected channel is encrypted. Flashing when Rx incoming signal is encrypted
✓	Scanned Channel
	Channel Scan On
	Zone Scan On
	Priority Scan On
	Dual Mode Scan On
	Repeater Talkaround Enabled
	Monitor Mode
	Open Audio
	Voice Mute Enabled

## KNG M-150 Mobile VHF (NEW) Operating Instructions

### To Change Groups:

- From home screen, press “**ZONE**”
- Use the arrow keypad or onscreen “**PREV/NEXT**” button to select zone
- To select the zone, press the onscreen “Enter” button or green “**OK**” button

### To Select a Tone:

- Find desired channel
- Press the onscreen “**TXCG**” button
- Use the arrow keypad or onscreen “**PREV/NEXT**” button to locate the desired tone
- To select the tone, press the onscreen “Enter” button or green “**OK**” button

\*\*Some channels use only one tone that is preselected when the frequencies are programmed in the radio. If you try and change the tone on these particular channels, the display will show an error message that reads: “**Picklist Selection Not Allowed**”

### To Create a Scan List:

- Press the onscreen “**SCAN**” button to turn the scan function On/Off
- Press the onscreen “**MENU**” button to create a scan list
- Use the arrow keypad to find “**Channel Select List**”
- Press the onscreen “Enter” button or green “**OK**” button
- Select or deselect channels in the group using the onscreen “+/-” or green “**OK**” button
- A successfully selected channel is identified with a checked box on the left side of the screen
- Selecting a channel twice is identified with a “(V)”. **Note: This will not affect the scan operation, and is only a programming feature that could not be removed.**

### To Create a Command Group:

- Listed as group #18 and #19 in your mobile radio
- Utilize the SDFD Fleet Map to identify the location(s) of the channel(s) you would like to add to your command group
- Once a desired channel has been located, press the onscreen “**CHAN +**” button
- Select either “**CMD Group 1**” or “**CMD Group 2**”
- The screen will show “**Enter Channel Index**”. Press “**1**” to begin programming your CMD Group with channel 1. (i.e. To begin programming with channel 5, you would select “**5**”). All subsequent channel assignments will be automatically ordered to the next available number based on your initial channel selection
- Once all channels have been added, switch to the desired **CMD GRP 1 or 2** using zone selection

### Monitor Mode:

- Enables radio to receive ALL TRAFFIC regardless of tone
- Used when other incident personnel are using the wrong tone and cannot be heard
- The default setting for Monitor Mode is OFF, to protect from unwanted transmissions and static
- To enter Monitor Mode, press the on-screen “**MENU**” button, scroll down and select “**Monitor Mode**” then select “**ON**”

**Squelch Adjustment:**

- Factory defaulted levels are fine for normal operations
- When adjusting, raise the squelch level until you hear static, then slightly reduce until the static terminates. This is the optimal squelch level for proper radio operation.
- To adjust the squelch, press the on-screen “**MENU**” button and select “**Squelch Adjust**”, “**Adjust Chan Squelch**”, then use the “+” or “-“ button to adjust as needed.
- To reset back to the factory setting, return to the “**Squelch Adjust**” screen and select “**Reset Squelch**”

**Talk Around:**

- Used to bypass the use of a repeater on a command channel, due to a weak repeater signal or the repeater being out of range.
- This function only works when the party trying to be reached is within the user’s line of sight.
- To enable “**Talkaround**”, press the on-screen “**MENU**”, select “**Talkaround**”, the select “**On**”

# Kenwood TK-790 Mobile VHF Operating Instructions

## On-Screen Display- Top Half Functions

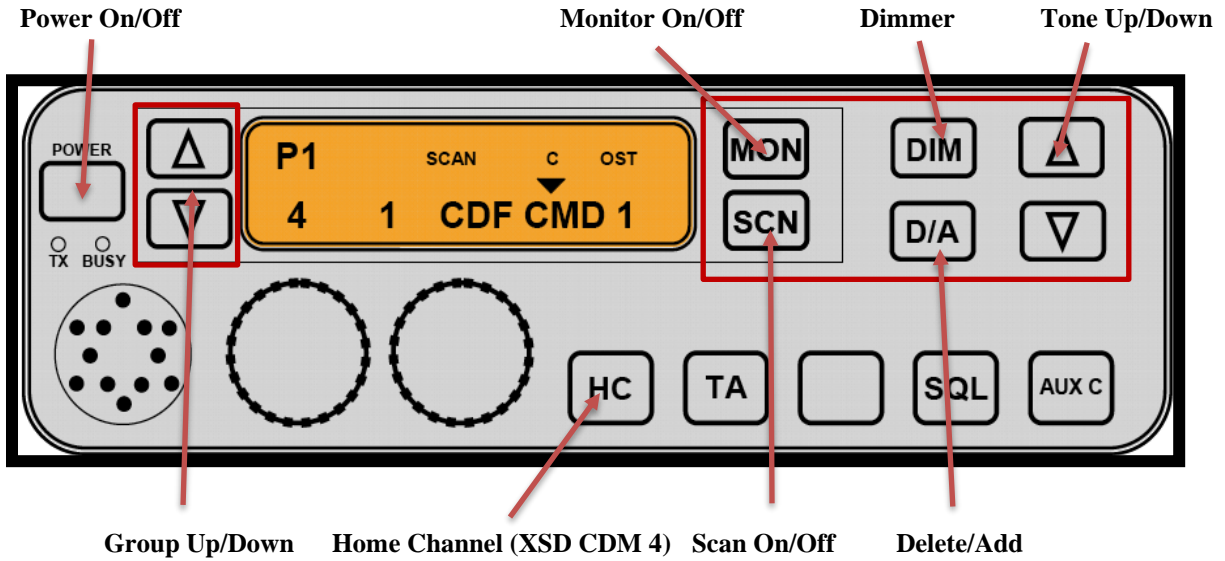

## On-Screen Display- Bottom Half Functions

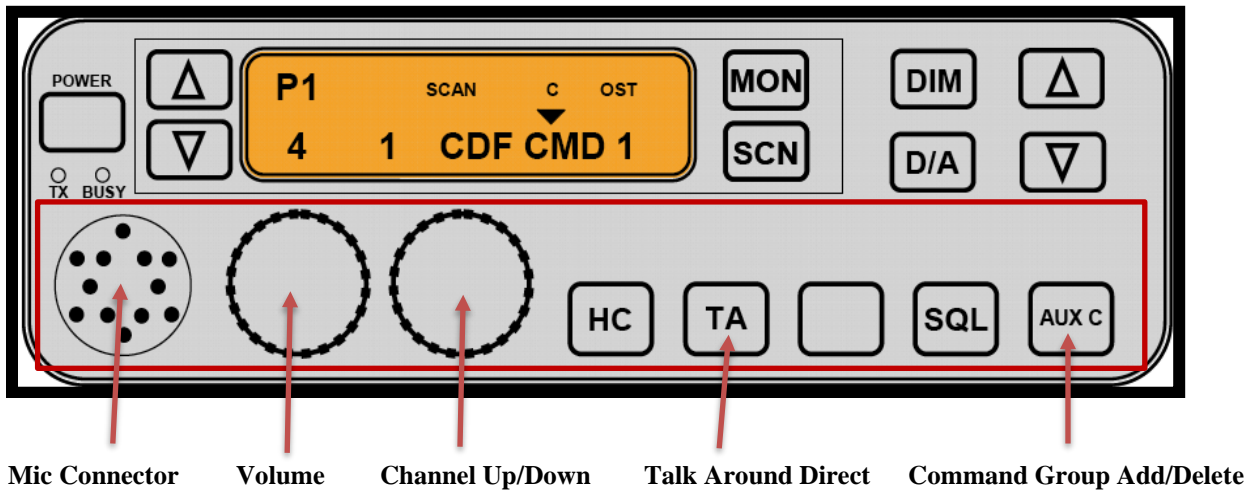

## On-Screen Display Area

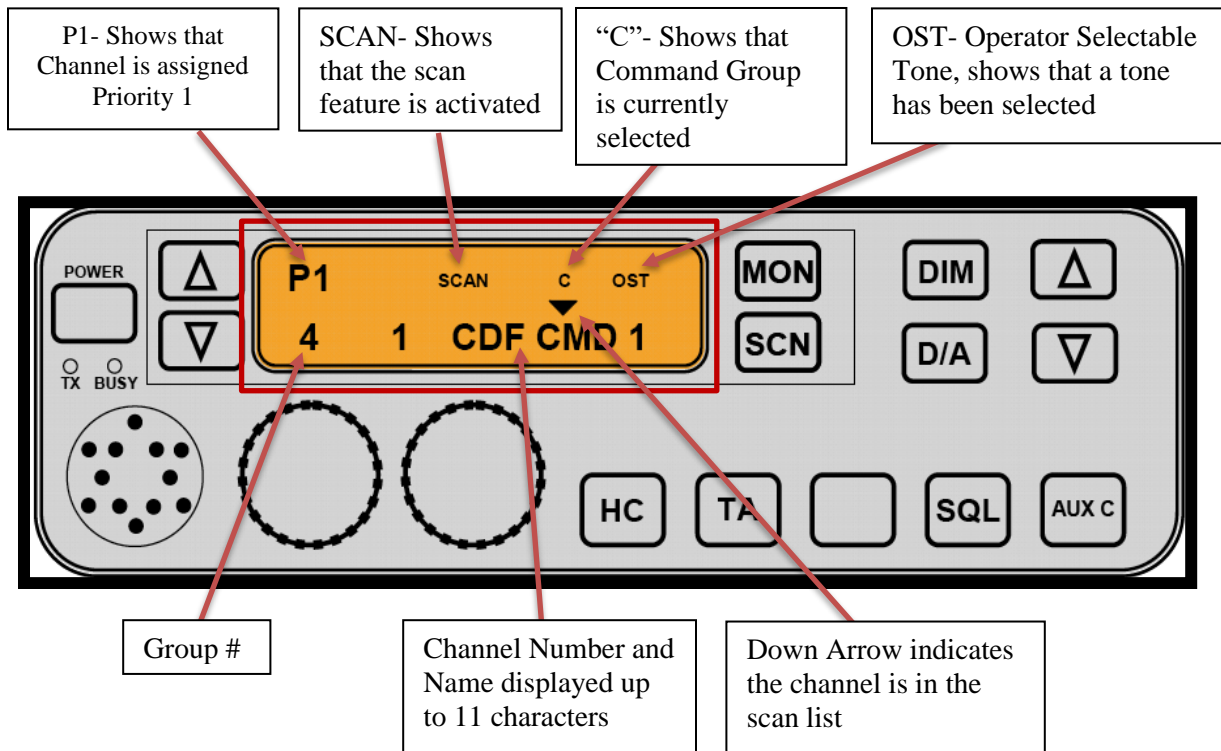

## Scanning Function

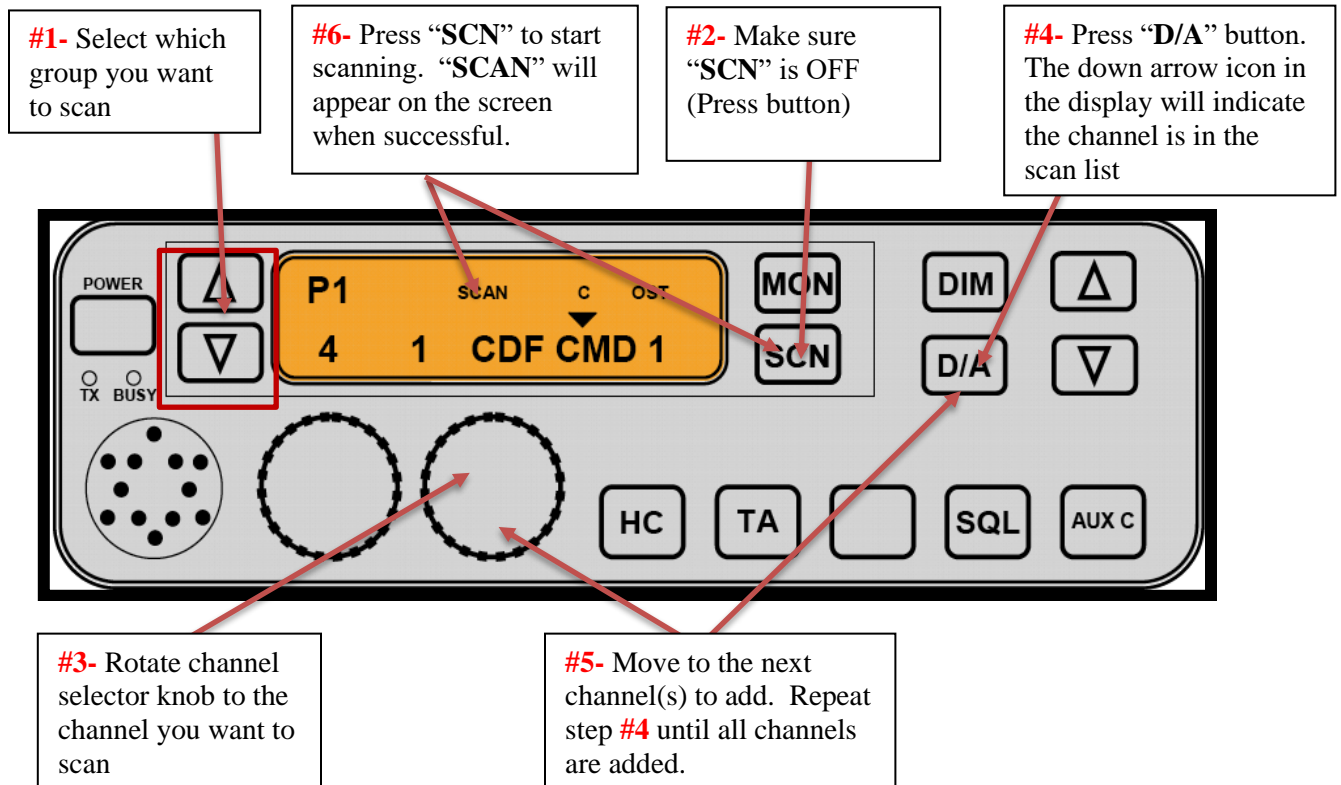

## Priority Scan Mode

**#4-** The “PP” icon indicates Programmable Priority and should appear on the screen

**#5-** To delete, press and hold the “SCN” button then press the “MON” button twice

**#3-** Select the desired channel, then press and hold the “SCN” button, and press the “MON” button twice.

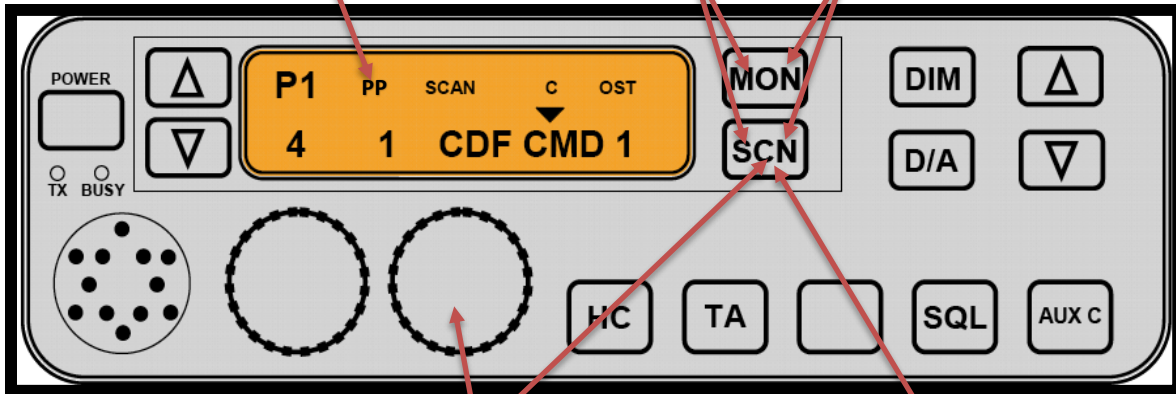

**#1-** The Priority 1 channel is (by default) the channel that has been selected on the display, before pressing the “SCN” button. To change the Priority 1 channel, scroll to the desired channel and press “SCN”. This is now the Priority 1 Channel.

**#2-** The Priority 2 channel is assigned by turning the “SCN” button off.

## Command Groups

**#4-** Press and hold the down arrow until a beep sounds and a “C” appears on the display. This indicates you are now in the operator-built command group.

**#5-** “C” icon will display when command group is selected, and will disappear when the group is deselected.

**#3-** Press and hold “AUX C” until a short beep is heard and a momentary “C” appears on the display



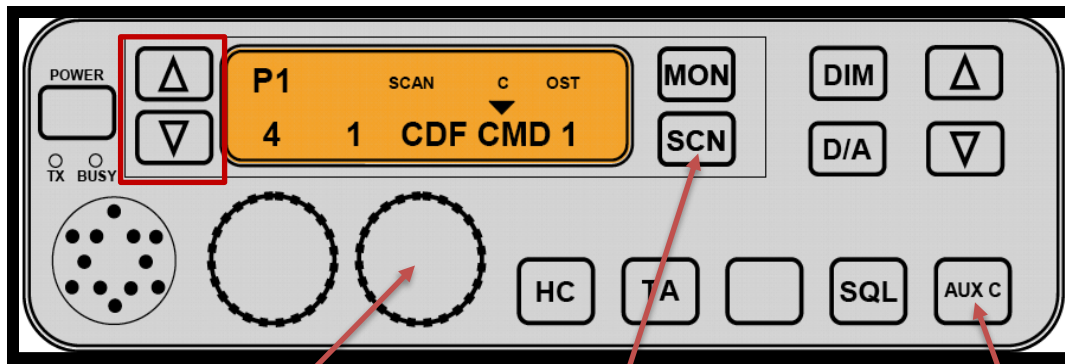

**#2-** Dial the channel selector knob to the desired channel to add to the command group

**#1-** Turn scan off to use command group

**#6-** Press and hold "AUX C" to remove individual channels from the command group. The channel will disappear and a short beep will sound when successful.

### Selecting Tones

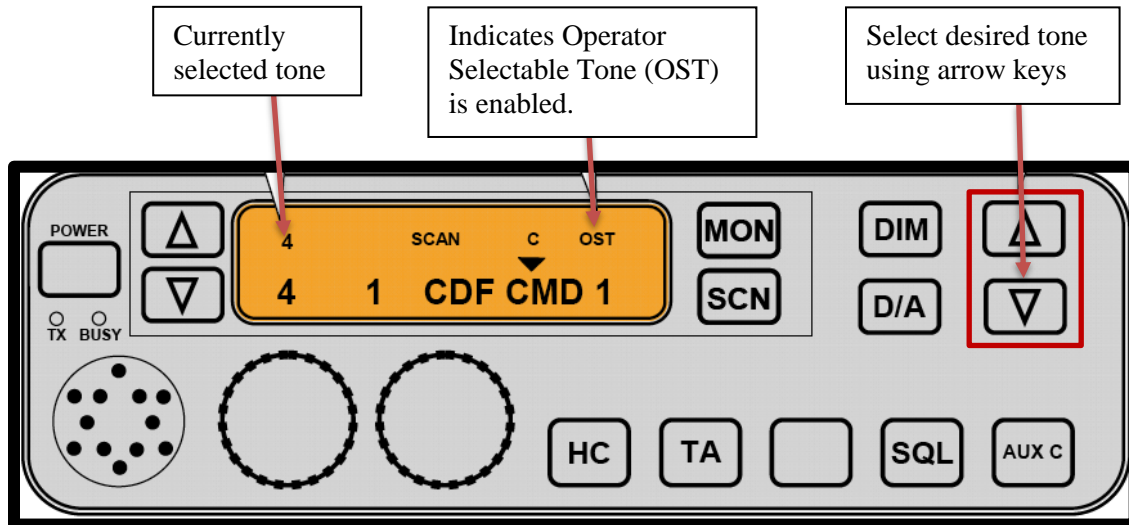

Currently selected tone

Indicates Operator Selectable Tone (OST) is enabled.

Select desired tone using arrow keys

\*\* For the Kenwood mobile radios, the tone is selected per each individual channel, not per group as with the portable BK radios. Once a tone has been selected for the channel, the user does not need to change it after using another channel. Once the channel has been changed to a previously used/programmed channel, the tone will remain at whatever was previously selected for that specific channel.



**Bendix-King KNG Mobile Radio**





## Changing Groups

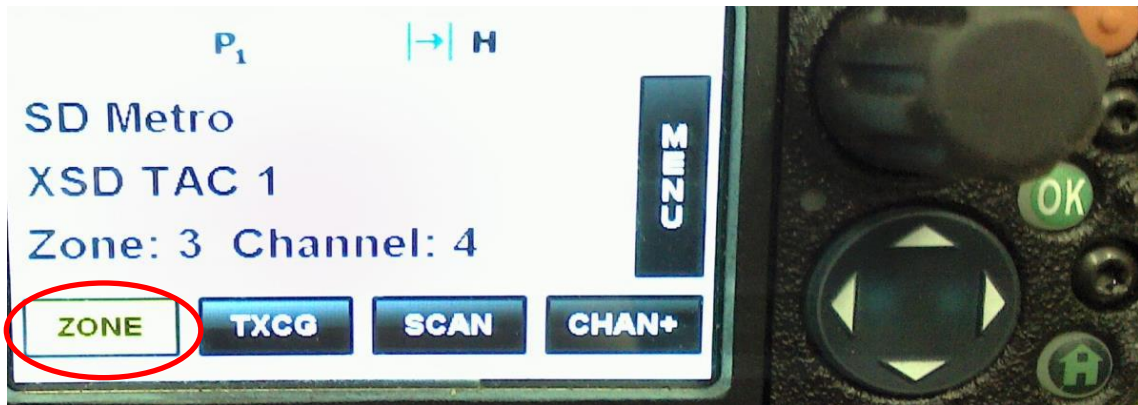

From Home Screen, Press “Zone”

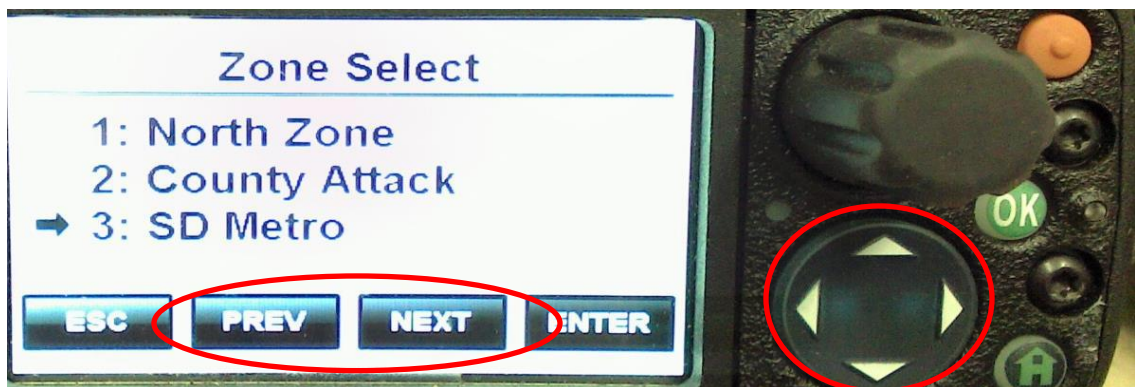

To Select Zone, use directional keypad or “PREV”/”NEXT” buttons

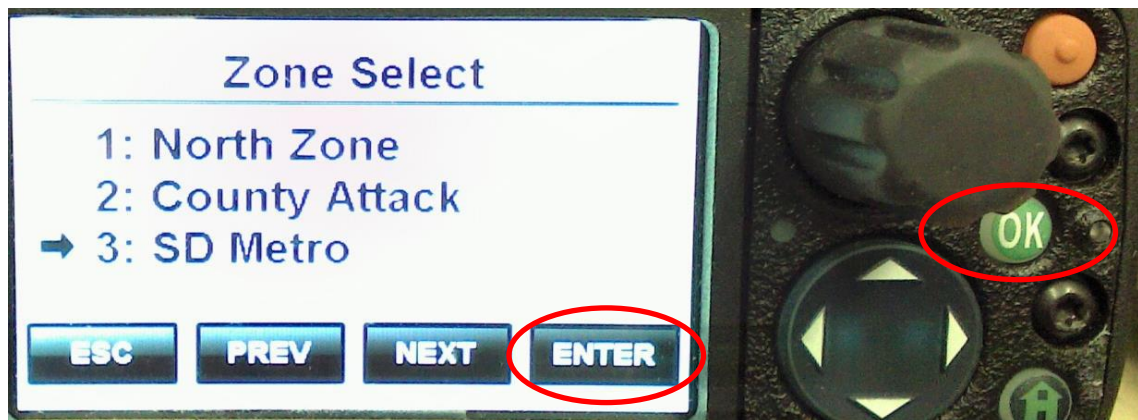

Once you find the desired zone, press “ENTER” on screen or “OK” button on console

## Selecting a Tone

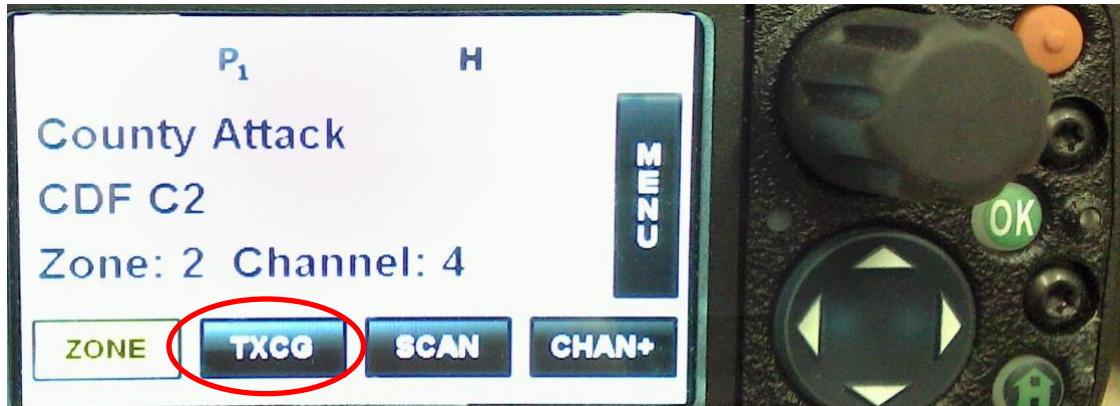

After finding desired channel, press the “TXCG” button

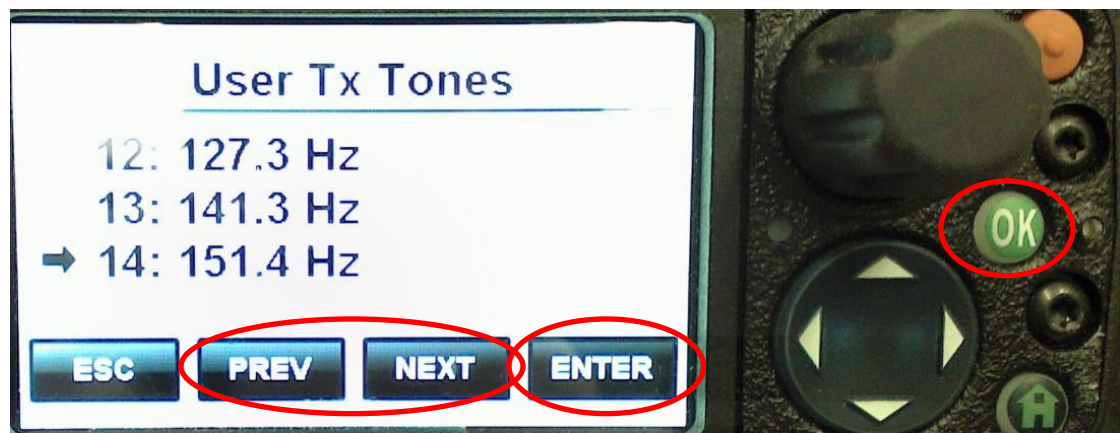

Use arrows or “PREV”/”NEXT” buttons to find tone, then press “ENTER” or “OK” button to select.



Some channels like XSD CMD 4 use only one tone which will be fixed to that channel. When trying to change a fixed tone, you will get the above message.



## Creating a Scan List

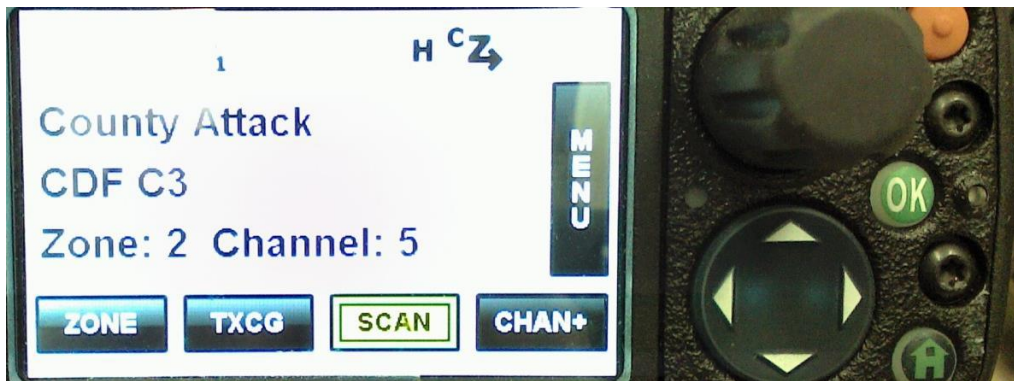

Press “SCAN” to turn scan on/off. To create a scan list, press “MENU”.

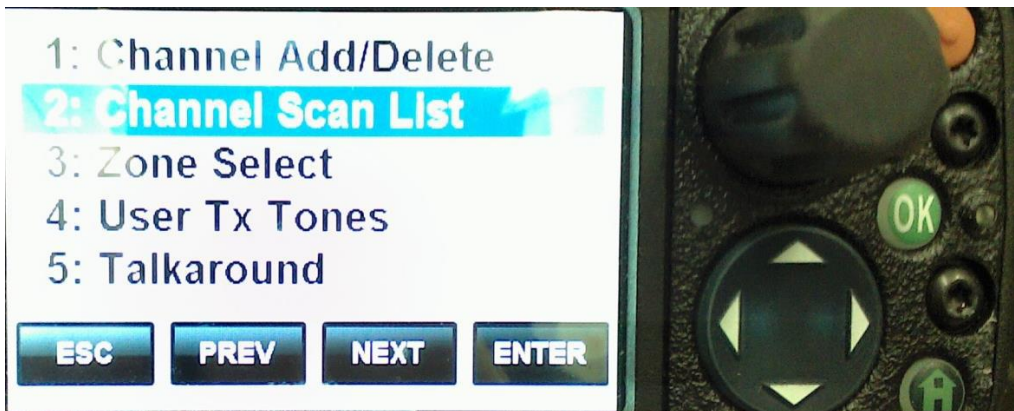

Use directional keypad to find “Channel Scan List” and press “Enter” or “OK” button to select.

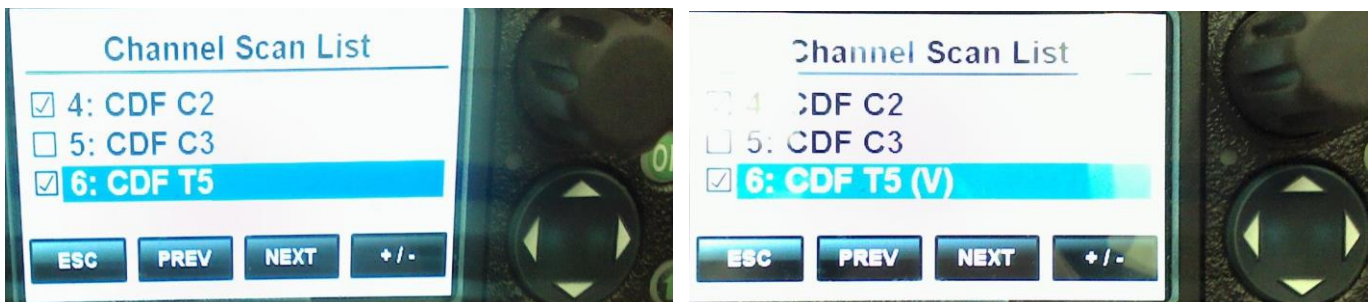

Select/Unselect channels using the +/- button. Selected channels will show a checkmark in the box. If selected twice, a “V” will appear. Disregard this, it is a programming error.

## Creating a Command Group

Once a zone is selected, scroll to desired channel to add to the command group and press the “CHAN+” button.

2023 XSD LOCAL GOVERNMENT PORTABLE RADIO POCKET CARDS			2023 XSD LOCAL GOVERNMENT PORTABLE RADIO POCKET CARDS			2023 XSD LOCAL GOVERNMENT PORTABLE RADIO POCKET CARDS			2023 XSD LOCAL GOVERNMENT PORTABLE RADIO POCKET CARDS			2023 XSD LOCAL GOVERNMENT PORTABLE RADIO POCKET CARDS		
CH	NO. ZONE B/U GROUP 1	INITIAL ATTACK GROUP 2	CH	METRO ZONE GROUP 3	CENTRAL/MTZ GROUP 4	CH	PROS GROUP 5	CDF C4-12 T1-12 GROUP 6	CH	CDF T13-32 GROUP 7	CDF T33-40 CF L1 GROUP 8	CH	CALFIRE L2 GROUP 9	AIR TO GROUND GROUP 10
1	XSD CMD 5	SDU 1	1	XSD CMD 4	XSD CMD 9	1	CDF CMD 1	CDF CMD 4	1	CDF TAC 13	CDF TAC 33	1	FKU 1	AIR GUARD
2	XSD TAC 5	SDU 2	2	XSD CMD 14	XSD TAC 1	2	CDF CMD 3	CDF TAC 1	2	CDF TAC 14	CDF TAC 34	2	FKU 2	CDF A/G 1
3	XSD CMD 6	CDF CMD 1	3	XSD TAC 3	XSD TAC 2	3	SDU 2	CDF CMD 7	3	CDF TAC 15	CDF TAC 35	3	TUU L	CDF A/G 2
4	XSD TAC 6	CDF CMD 2	4	XSD TAC 4	XSD CMD 15	4	RRU 2	CDF CMD 8	4	CDF TAC 16	CDF TAC 36	4	MMU 1	CDF A/G 3
5	XSD TAC 10	CDF CMD 3	5	XSD CMD 10	XSD TAC 6	5	FS CNF	CDF CMD 9	5	CDF TAC 17	CDF TAC 37	5	MMU 2	CDF A/G 4
6	XSD CMD 7	CDF TAC 1	6	XSD TAC 10	XSD TAC 18	6	XSD CMD 1	CDF CMD 10	6	CDF TAC 18	CDF TAC 38	6	TCU L	CDF A/G 5
7	XSD TAC 7	CDF TAC 5	7	XSD A/G 3	XSD A/G 2	7	XSD CMD 11	CDF CMD 11	7	CDF TAC 19	CDF TAC 39	7	CZU L	CDF A/G 6
8	XSD TAC 11	CDF TAC 8	8	VFIRE 22	SDU 2	8	FIRE OC	CDF CMD 12	8	CDF TAC 20	CDF TAC 40	8	SCU L	CDF A/G 7
9	ESC DISP V	CDF A/G 2	9	VFIRE 23	CDF CMD 1	9	V FIRE 22	CDF TAC 1	9	CDF TAC 21	SDU 1	9	LNU EAST	CDF A/G 8
10	XSD CMD 13	XSD CMD 1	10	SDU 2	CDF CMD 2	10	V FIRE 23	CDF TAC 2	10	CDF TAC 22	SDU 2	10	LNU WEST	CDF A/G 9
11	XSD TAC 8	XSD CMD 2	11	CDF CMD 1	CDF CMD 3	11	CDF T8	CDF TAC 3	11	CDF TAC 23	RRU 1 W	11	AEU L	CDF A/G 10
12	V FIRE 26	XSD CMD 3	12	CDF CMD 2	CDF TAC 1	12	NIFC T2	CDF TAC 4	12	CDF TAC 24	RRU 2	12	NEU WEST	CDF A/G 11
13	XSD CMD 8	XSD TAC 11	13	CDF CMD 3	CDF TAC 5	13	FS A/G 59	CDF TAC 5	13	CDF TAC 25	RRU 3 E	13	NEU EAST	CDF A/G 12
14	XSD CMD 16	XSD TAC 12	14	CDF TAC 1	XSD CMD 1	14	FS A/G 53	CDF TAC 6	14	CDF TAC 26	BDU 1	14	MEU L	CDF A/G 13
15	XSD TAC 17	FS CNF	15	CDF TAC 5	XSD CMD 2	15	CDF A/G 1	CDF TAC 7	15	CDF TAC 27	BDU 2	15	TGU L	CDF A/G 14
16	XSD TAC 15	CNF ADM	16	XSD TAC 11	XSD CMD 3	16	CDF A/G 2	CDF TAC 8	16	CDF TAC 28	BDU 3	16	BTU L	CDF A/G 15
17	XSD TAC 14	FS R5 T6	17	XSD CMD 1	V FIRE 22	17	XSD CMD 21	CDF TAC 9	17	CDF TAC 29	SLU L	17	HUU L	CDF A/G 16
18	XSD TAC 12	NIFC T2	18	XSD CMD 2	V FIRE 23	18	CDF C2	CDF TAC 10	18	CDF TAC 30	BEU E	18	SHU L	
19	XSD A/G 1	A/G 59	19	CDF A/G 2	XSD TAC 11	19	OC ACCESS	CDF TAC 11	19	CDF TAC 31	BEU W	19	LMU L	
20	AIR GUARD	AIR GUARD	20	AIR GUARD	CDF A/G 2	20	AIR GUARD	CDF TAC 12	20	CDF TAC 32		20	SKU L	AIR GUARD

2023 XSD LOCAL GOVERNMENT PORTABLE RADIO POCKET CARDS			2023 XSD LOCAL GOVERNMENT PORTABLE RADIO POCKET CARDS			2023 XSD LOCAL GOVERNMENT PORTABLE RADIO POCKET CARDS			2023 XSD LOCAL GOVERNMENT PORTABLE RADIO POCKET CARDS			2023 XSD LOCAL GOVERNMENT PORTABLE RADIO POCKET CARDS		
CH	FS & LG A/G GROUP 11	NIFC GROUP 12	CH	RIVERSIDE 1 GROUP 13	RIVERSIDE 2 GROUP 14	CH	CLONE GRP GROUP 15	FS 1 & FWS GROUP 16	CH	USFS 2 GROUP 17	BLM/FED/WX GROUP 18	CH	INTEROP GROUP 19	VFIRE/VTAC GROUP 20
1	AIR GUARD	NIFC C1	1	RVC T1	RVC C10	1	WX 2	FS R5 T4	1	FS SQF	BLM SOA	1	CESRS D	V FIRE 21
2	A/G 08	NIFC C2	2	RVC T2	RVC C12	2		FS R5 T5	2	FS SQF ADM	BLM ADMN	2	CALCORD	V FIRE 22
3	A/G 14	NIFC C3	3	RVC T3	RIV C20	3		FS R5 T6	3	FS SNF	BLMCND-F	3	XSD CMD 12	V FIRE 23
4	A/G 24	NIFC C4	4	RVC T4	MUR DISP	4		R5 PRJT	4	FS STF	BLMCDD-F	4	XSD CMD 22	V FIRE 24
5	A/G 41	NIFC C5	5	RVC T5	MUR WEST	5		R5 SERVICE A	5	FS ENF	BLMNODW	5	XSD TAC 21	V FIRE 25
6	A/G 43	NIFC C6	6	RVC T6	MUR EAST	6		R5 SERVICE B	6	FS HTF	BLMNODEF	6	OES 1A	V FIRE 26
7	A/G 53	NIFC C8 NC1	7	RVC T7	MUR TAC 1	7		R5 SERVICE C	7	FS TMU 1	BLM MLF	7	OES 1B	V CALL 10
8	A/G 59	NIFC C9 IR1	8	RVC T8	MUR TAC 2	8		R5 SERVICE D	8	FS TNF ADM	YNP	8	OES 2A	V TAC 11
9	XSD A/G 1	NIFC C10 IR2	9	RVC T9	HMT MAIN	9		FS CNF	9	FS TNF	FED CMN 1	9	OES 2B	V TAC 12
10	XSD A/G 2	NIFC C11 IR3	10	RVC T10	HMT TAC 1	10		CNF ADM	10	FS MNF	FED CMN 2	10	MARINE 12	V TAC 13
11	XSD A/G 3	NIFC C12 IR4	11	RVC T11	HMT TAC 2	11		US FWS	11	FS PNF	FED CMN 3	11	MARINE 16	V TAC 14
12	RVC A/G	NIFC T1	12	RVC C1	COR LOCAL	12		FS BDF	12	FS SHF	FED CMN 4	12	MARINE 21A	V TAC 33
13	BDC A/G	NIFC T2	13	RVC C2	COR CMD	13		BDF ADM	13	FS LNF	FED NIMS	13	MARINE 22A	V TAC 34
14	LAC A/G	NIFC T3	14	RVC C3	COR TAC 1	14		FS ANF	14	FS SRF	WX 1	14	MARINE 23A	V TAC 35
15	LFD A/G	NIFC T4	15	RVC C4	COR TAC 2	15		ANF ADM	15	SFR SERVICE	WX 2	15	MARINE 83A	V TAC 36
16	XLC A/G	NIFC T5	16	RVC C5	COR TAC 3	16		FS LPF	16	FS KNF	WX 3	16	XSD TAC 9	V TAC 37
17	VNC A/G	NIFC T6	17	RVC C6	COR TAC 4	17		LPF ADMIN	17	FS MDF	WX 4	17	VSAR 16	V TAC 38
18	SBC A/G		18	RVC C7		18		LPF TAC F3	18		WX 5	18	VMED28	
19	KRN A/G		19	RVC C8		19		FS INF N	19		WX 6	19	VMED29	
20	AIR GUARD		20	RVC C9		20	XSD 23D	FS INF S	20		WX 7	20	CESRS R	

2023 XSD LOCAL GOVERNMENT PORTABLE RADIO POCKET CARDS			2023 XSD LOCAL GOVERNMENT PORTABLE RADIO POCKET CARDS			2023 XSD LOCAL GOVERNMENT PORTABLE RADIO POCKET CARDS		
CH	BDC-LACO 1 GROUP 21	LACO 2 GROUP 22	CH	LOB-SBC GROUP 23	VNC-KRN GROUP 24	CH	STATEWIDE GROUP 25	
1	BDC V1	LAC V-7D	1	LOB V-1	VNC DISP	1	IMP BLUE	
2	BDC V2	LAC V-8D	2	LOB V-2	VNC CMD 2	2	SLC L	
3	BDC V3	LAC V-9D	3	LOB V-3	VNC TAC 3	3	XSL C4	
4	BDC V5	LAC V-10D	4	LOB V-4	VNC CMD 5	4	FCO DST 1	
5	BDC V6	LAC V-11D	5	LOB V-5D	VNC TAC 6	5	XMA CMD	
6	BDC V-7	LAC V-12D	6	LOB V-6D	VNC CMD 8	6	TLC 1	
7	BDC V-15	LAC V-13D	7	LOB V-7D	VNC TAC 9	7	SCC CMD	
8	BDC V-16	LAC V-17D	8	LOB V-8D	VNC CMD 12	8	XSM C51	
9	BDC V-17	LAC V-18	9	LOB V-9D	VNC CMD 17	9	TLU CMD	
10	BDC V-18	LAC V-19	10	SBC C-1	KRN 1	10	CAL CMD	
11	BDC V-19	LAC RIC	11	SBC C-2	KRN 2	11	XED CMD	
12	BDC V-20	LARTCS 3V	12	SBC C-3	KRN 3	12	XAM CMD	
13	BDC V4	LARTCS 4V	13	SBC C-4	KRN 4	13	VXCC C1	
14	OTO-V1	LARTCS 5V	14	SBC C-5	KRN 5	14	MRN L	
15	LAC V-1	FCA V-1D	15	SBC C-6	KRN T V2	15	XNA FIRE	
16	LAC V-2	FCA V-2D	16	SBC T-7	KRN T V3	16	PCF CMD	
17	LAC V-3	FCA V-3D	17	SBC T-8	KRN T V4	17	NEV CO FIRE	
18	LAC V-4	FCA V-4D	18	SBC T-9	KRN T V5	18	YUBA FTL	
19	LAC V-5	LAC V-14D	19	SBC T-10	KRN T16	19	YUBA CMD	
20	LAC V-6D	LAC V-15D	20	SBC T-12	KRN 27	20	BUT SUP	

## Key Review Points for Radio Use

- \*\*Some mutual aid incidents with the U.S. Forest Service and/or Cal Fire may require the point of contact to utilize “Forest Net”. Forest Net is the term used to describe the local unit’s dispatch, and is identified in the SDFD fleet map by different names, such as “FS BDF” (San Bernardino), “FS CNF” (Cleveland), “FS ANF” (Angeles), etc. Ensure correctness of the appropriate forest when switching to “Forest Net”, as the frequencies differ from forest to forest.
- \*\*XSD A/G is the new county-wide channel for LRA (Municipal) incidents
- \*\*Due to FCC monitoring protocols and the possibility of creating interference with other working incidents, ALL traffic to aircraft must be transmitted on the designated A/G channel, not on TAC.
- \*\*When cloning is needed, it should be done on Group 15. Group 14 is an alternate cloning group for large incidents that require the use of two groups for the incident frequencies. If both groups 14 and 15 are utilized and cloned over at an incident, all affected radios will need to be re-programmed upon return to the home unit. If only group 15 is utilized for cloning, radio re-programming will not be necessary upon return to the home unit.
- \*\*On the newer Commander radios, the keypad can be locked by pressing and holding the FCN key located in the top-right corner of the keypad. This will help ensure that the tone will not be accidentally changed when walking through heavy brush.
- \*\*When responding to an incident, there are FOUR MAIN CHANNELS that need to be scanned, either in the command group or a standard group. These channels are CMD, TAC, A/G, and AIRGUARD, and will be identified by dispatch for Initial Attack or located in the IAP when at a large incident.
- \*\*Use of 800mhz on vegetation fire has been approved by the San Diego County Chiefs; however, they are ONLY to be used in NON-TACTICAL SITUATIONS only. All pertinent operations-related traffic must be communicated through the predefined incident VHF frequencies. Use extreme discipline when communicating via 800mhz as many cooperating resources are not privy to the same frequencies.
- \*\*11A is the travel channel that is used only until the units arrive at the rendezvous point for strike team form-up. Once the strike team is formed up, switch to group/zone 12. Used for in-county assignments ONLY. Be aware that other units will be using this travel channel as well.
- \*\*When using the 800mhz radios, Group/Zone 12 has preferred direct frequencies for travel use: They are as follows:  
CESARS D, ITAC 1, 2, 3, and 4 (preferred state-wide), FMAR D (not preferred, but may be used if needed), and FMAR Repeat 12A (Used to contact any ECC state-wide).
- \*\*Check VHF portable batteries when performing Apparatus Status Report updates each 1<sup>st</sup> day back of the go-around for each division. Press and hold PTT button for 3 seconds, and if the screen shows “LO BATT”, the batteries need to be changed.



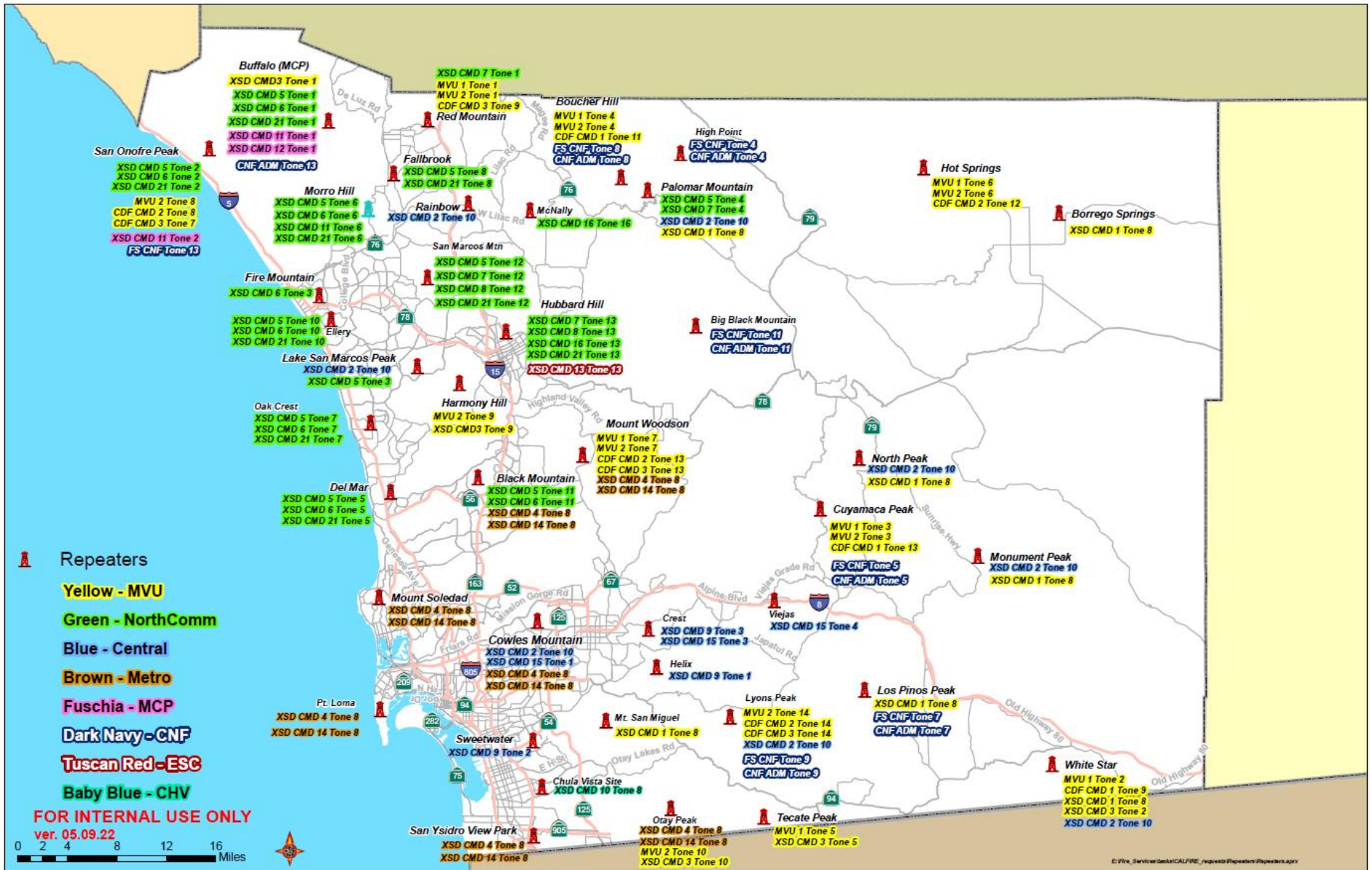

CAL FIRE / SD COUNTY FIRE CHANNELS											
MVU 1		MVU 2		CDF CMD 1		CDF CMD 2		CDF CMD 3		XSD CMD 3	
Red Mountain	1	Red Mountain	1	White Star	9	San Onofre Peak	8	San Onofre Peak	7	Buffalo (MCP)	1
White Star	2	Cuyamaca Peak	3	Boucher Hill	11	Hot Springs	12	Red Mountain	9	White Star	2
Cuyamaca Peak	3	Boucher Hill	4	Cuyamaca Peak	13	Mount Woodson	13	Mount Woodson	13	Tecate Peak	5
Boucher Hill	4	Hot Springs	6			Lyons Peak	14	Lyons Peak	14	Harmony Hill	9
Tecate Peak	5	Mount Woodson	7							Otay	10
Hot Springs	6	San Onofre Peak	8								
Mount Woodson	7	Harmony Hill	9								
		Otay	10								
		Lyons Peak	14								
NORTH ZONE		NORTH ZONE		NORTH ZONE		NORTH ZONE		CENTRAL ZONE		METRO ZONE	
XSD CMD 5		XSD CMD 6		XSD CMD 7		XSD CMD 8		XSD CMD 9		XSD CMD 10	
Buffalo (MCP)	1	Buffalo (MCP)	1	Red Mountain	1	San Marcos Mtn (VTA)	12	Helix	1	Chula Vista Site	8
San Onofre Peak	2	San Onofre Peak	2	Palomar Mountain	4	Hubbard Hill	13	Sweetwater	2		
Lake San Marcos Peak	3	Fire Mountain	3	San Marcos Mtn (VTA)	12			Crest	3		
Palomar Mountain	4	Del Mar	5	Hubbard Hill	13						
Del Mar	5	Morro Hills	6								
Morro Hills	6	Oak Crest (ENC)	7								
Oak Crest (ENC)	7	Ellery (CBD)	10								
Fallbrook	8	Black Mountain	11								
Ellery (CBD)	10										
Black Mountain	11										
San Marcos Mtn (VTA)	12										
CAMP PENDLETON		CAMP PENDLETON		ESCONDIDO		CENTRAL ZONE		NORTH ZONE		NORTH ZONE	
XSD CMD 11		XSD CMD 12		XSD CMD 13		XSD CMD 15		XSD CMD 16		XSD CMD 21	
Buffalo (MCP)	1	Buffalo (MCP)	1	Hubbard Hill	13	Cowles Mountain	1	Hubbard Hill	13	Buffalo (MCP)	1
San Onofre Peak	2					Crest	3	McNally (VCF)	16	San Onofre Peak	2
Morro Hills	6					Viejas	4			Del Mar	5
										Morro Hills	6
										Oak Crest (ENC)	7
										Fallbrook	8
										Ellery (CBD)	10
										San Marcos Mtn (VTA)	12
										Hubbard Hill	13
USFS CLEVELAND CHANNELS				XSD VOTED CHANNELS							
FS CNF		CNF ADM		XSD CMD 1		XSD CMD 2		XSD CMD 4 (METRO)		XSD CMD 14 (METRO)	
High Point	4	High Point	4	Palomar Mountain	8	Rainbow	10	Mount Woodson	8	Black Mountain	8
Cuyamaca Peak	5	Cuyamaca Peak	5	Borrego Springs	8	Palomar Mountain	10	Mount Soledad	8	Mount Woodson	8
Los Pinos Peak	7	Los Pinos Peak	7	North Peak	8	Lake San Marcos Peak	10	Cowles Mountain	8	Mount Soledad	8
Boucher Hill	8	Boucher Hill	8	Monument Peak	8	North Peak	10	Pt. Loma	8	Cowles Mountain	8
Lyons Peak	9	Lyons Peak	9	Mt. San Miguel	8	Cowles Mountain	10	San Ysidro View Park	8	Pt. Loma	8
Big Black Mountain	11	Big Black Mountain	11	Los Pinos Peak	8	Monument Peak	10	Otay Peak	8	San Ysidro View Park	8
San Onofre Peak	13	Buffalo (MCP)	13	White Star	8	Lyons Peak	10	Black Mountain	8	Otay Peak	8
						White Star	10				

5/9/2022

# WILDLAND FIRE SIZE-UP

1. SIZE
2. FUEL TYPE
3. RATE OF SPREAD
4. ASPECT
5. WINDS
6. STRUCTURE THREAT
7. POTENTIAL
8. HAZARDS
9. RESOURCE NEEDS

Example:

1. The fire is approximately ? acres,
2. and is burning in **light, medium, heavy** fuels,
3. with a **slow, moderate, rapid** rate of speed.
4. The fire is burning in the **bottom of the canyon, midslope, along the ridgeline**
5. with winds blowing the fire **upslope, downslope**, out of the **west, south, north, east**.
6. This fire **is, is not** an immediate threat to structures.
7. This fire has the potential to grow to ? acres **if not kept between the highway and the river bottom, allowed to get into the light fuels, not attacked quickly**, etc.
8. There are **no obvious hazards, multiple hazards** which include **children in the canyon, high voltage lines running over the incident, citizens taking suppression action, directly below the approach path for ? airport**, etc.
9. I request      alarm vegetation, Type 1/Type 3 strike teams, helicopter, airtankers, handcrews,...
10. Engine      assuming          IC

# INITIAL RESPONSE ASSIGNMENTS

VEGETATION RESPONSES			
<b>INITIAL ATTACK</b>	<b>VEGETATION 1ST ALARM:</b>		<b>VEGETATION 2ND ALARM:</b>
2 E	2 E (4 E total)		4 E
AOPNOT	2 BR		2 BR
	4 BC	*Immediately dispatch and backfill 1 Operations BC with a straight day (SD) BC	2 BC
	2 COPTER		1WT
	HT729 (when avail)		FM (N)
	WTNOT		STAFF
	SC1		
	ADMIN BC (N)		<b>VEGETATION 3RD ALARM:</b>
	PDS (N)		4 E
	Duty Support (N)		2 BR
	COUNTY COPTER IF OURS IS UNAVAILABLE		2 BC
	STAFF IF EXTREME FPI		1WT
			STAFF

STRIKE TEAMS			
<b>TYPE I</b>	<b>TYPE III</b>	<b>OES STRIKE TEAM</b>	<b>TASK FORCE</b>
5 E	5 BR	5 OES UNITS	RESOURCES REQUESTED
1 BC	1BC	1 BC	1 BC
SC (N)	SC (N)	SC (N)	SC (N)
STAFF	STAFF	STAFF	STAFF

## WILDLAND AIR OPERATIONS

*For questions, call to Air Operations at (858) 573-1437.*

---

### **COPTERS 1 and 2:**

Copters 1 and 2 will provide an immediate initial attack response, including up to 375 gallons of water from a fixed water tank to vegetation fires within the city and the region. Both helicopters have a self-fill capability (hover drafting by hydraulic snorkel), that fill the tank in approximately 17 seconds. Remember, wildland fires can become complex very quickly. Use either helicopter for aerial size up, fire potential, tactical priorities, fire mapping and trigger points for requesting additional resources.

WATER-FILL SUPPORT: Dependent upon the location of the incident and the closest available water source to the incident, the helicopter's water-drop tank may need to be "ground filled" by an engine company or hydrant. To facilitate "ground fill" operations, Copters 1 and 2 carry a twelve-foot length of 2 ½ inch hose (whip) with a shut-off butt, designed to attach to the end of an engine company line.

When SDFD helicopters are assigned to a vegetation fire, additional engine companies may be requested to respond to provide water fill support and or/ landing/takeoff site management. If requested, this additional engine company will respond to a location designated by the onboard helicopter crew chief or pilot, or to a site pre-identified or mutually agreed upon by the aircrew and responding Engine Company. A helispot directory is available on the MDC, and identifies at least one approved helispot in each engine company's district.

NIGHT-TIME OPERATIONS: SDFD helicopters are the **only** helicopters approved for nighttime fire suppression missions within the City of San Diego or other incorporated Cities on a case-by-case basis. Important nighttime considerations are:

- Copter 1 will not hover-fill during nighttime conditions.
- Nighttime water drop operations will require ground engines to provide water fill support and site security.
- Water-fill support by engine companies will only occur at approved city helispots or airports.

### **OTHER HELICOPTERS:**

The following available helicopters are all Type 2. A minimum of 300 gallons of water from a fixed water tank, supplied with an electric snorkel system capable of filling their tanks in approximately 60-90 seconds. They also have the ability to ground fill if needed. However, **SDFD helicopters are the only helicopters approved for night firefighting operations.**

<u>CALLSIGN</u>	<u>DEPT</u>	<u>TYPE</u>	<u>LOCATED AT</u>
COPTER 10 & 12	Sheriff/CDF	B205	Gillespie Field / Fallbrook Air Park
H538	USFS	B212	Ramona Air Base
H301	CDF	B212	Hemet Air Base / Riverside

## **COMMUNICATIONS:**

Wildland fire incidents within the City of San Diego are managed on the City's 800 MHz system. If other air resources are also responding to the same incident, Air Ops may request a different channel that all air resources can share, as follows:

Sheriff: When a San Diego Fire-Rescue Department IC makes a request for a non-City fire helicopter, and it is known that the fire helicopter responding is from the San Diego County Sheriff's (Copter 10 and/or Copter 12), our FCC will provide the Area Fire Coordinator with 800 MHz City command and tactical channels and the appropriate 800 MHz air-to-ground channel. From that point forward, all air-to-ground radio communications conducted by SDFD helicopters (Copter 1 and/or 2) and the San Diego County Sheriff's helicopters will be conducted on the designated command, tactical and air-to-ground channels.

CDF / USFS: If CDF and/or USFS aircraft have been ordered or are actively engaged in fire suppression efforts within the City of San Diego, all aircraft radio traffic will conform to pre-established and pre-designated radio channels (VHF-FM, CDF A/G, FS A/G, etc.). The Incident Commander or Operations Chief will be responsible for advising all ground resources of the transition from the City 800 MHz system to the VHF-FM radio for subsequent air-to-ground communications.

Diverting or canceling helicopters during an initial response shall be coordinated by the IC, FCC and the OES Area Fire Coordinator.

## **REQUESTING FOR HELICOPTER SUPPORT:**

When fire helicopters are requested, the closest resources available will be dispatched or diverted from another fire to your incident depending on the potential and threat to lives and property. Remember, helicopters are most effective on the initial fire attack.

**BEFORE CONTACTING AIRCRAFT, you need to know:**

- Hazards
- Your location
- Your identifier
- Your tactical objective
- Aircraft identifier
- Aircraft frequencies
- Primary and secondary targets
- Wind speed and direction

**OPERATING PROCEDURES (Use standard fire terminology)**

- Head
- Heel
- Right flank
- Left flank
- Spot fire

## HAVE and KNOW THE TACTICAL PLAN

- Anchor & flank
- Hot spot
- Buy time / “check” the fire spread
- Secure the edge

## USE STANDARD TARGET ORIENTATION TECHNIQUES

- Parts of the fire
- Clock orientation (from the aircraft’s position)
- Right, left, nose, tail
- High, even, low
- Cardinal points (north, south, east, and west).

## STANDARD TARGET DESCRIPTION

- Use easily identifiable target references
- In relation to previous drop
- From your position
- Topographic or terrain features (draws, ridges, etc.)
- Man-made features
- Area of specific fire activity (flare-up, spot fire, isolated tree torching, etc.)
- Cardinal direction

## FEEDBACK

- Give honest, constructive feedback after the drop
- Early, late, uphill, downhill, on target, etc.
- Communicate adjustments for subsequent drops
- If conditions allow, pilot will adjust based on feedback

---

## **AIR TANKERS and AIR TACTICAL GROUP SUPERVISOR (ATGS):**

- 2 air tankers are available at Ramona Air Base
- Air tankers have a two-digit number as their call sign, e.g., air “Tanker 03”, “Tanker 81”, etc.
- Air tankers come with an Air Attack Group Supervisor (ATGS), or lead plane.
- ATGS out of Ramona Air Base is “Air Attack 330”

## ATGS RESPONSIBILITIES:

- Coordination of all tactical and logistical aircraft on the incident
- Establish & maintain communication with all ground forces and aerial resources
- Coordination of aerial resources to support ground tactics
- Prevention of airspace conflicts
- ATGS will contact either the IC on or Copter 1 on an air-to-air or air-to-ground frequency when they are 12 miles out from the incident.

ATGS, tankers, and helicopters responding with SDFD helicopters at scene, will not enter the fire traffic area until cleared in by the controlling aircraft for the incident.

If communications are not established, responding aircraft will hold at 7 nautical miles away from the incident until they are established.



---

# STRUCTURE DEFENSE GUIDELINES & STRUCTURE DEFENSE TRIAGE PROCESS (S-FACTS)

---

*These guidelines will assist Division/Group Supervisors, Strike Team Leaders, and Engine Personnel in the development of a safe and aggressive Plan to protect structures.*

## SURVIVAL

- Initial Assessment: can you survive here? **If not, LEAVE NOW!**
- Is there a Safety Zone nearby? **If not, LEAVE NOW!** (IRPG)
- Do you have a viable Escape Route?
- What is the decision point at which you will leave based on fire behavior and rate of spread?
- Is there a Temporary Refuge Area (TRA) on site? **If not, LEAVE NOW!**
  - Preplanned area for immediate, temporary refuge
    - Use of fire shelter should not be necessary
  - Is there a viable Escape Route to the TRA or Safety Zone?
- Is "Prep and Go" tactic an option?
- Do you have communications with your supervisor and adjoining forces?
- If safety issues cannot be mitigated, **LEAVE NOW!**

## FIRE ENVIRONMENT

- Can you survive based on current and expected fire behavior? **If not, LEAVE NOW!**
- Look up, Look Down, Look Around Indicators:
  - Fuels (characteristics, moisture, temperature)
    - What will the intensity of the fire be when it arrives?
    - How long will it take to consume the fuels?
  - Wind
    - Current speed/direction
    - Expect changing winds
  - Terrain
    - Are you in a chute, chimney, or saddle? **If yes, LEAVE NOW!**
    - Is wind in alignment with topography?
    - What is your position relative to topography?
    - Are you mid slope or on top of a ridge?
  - Atmospheric Stability
  - Fire Behavior (requires constant monitoring)
    - Spotting, crowning, sheeting, rate of spread?
    - Flame length and height?
- Other weather considerations:
  - What is the current relative humidity?
    - Is there an expected change?
  - Are thunderstorms forecasted?

## ACCESS

- Is access compatible with time and distance factors necessary to utilize as an Escape Route to a Safety Zone?
  - Road surface adequate for speed necessary?
  - Adequate width?
  - Turnaround/turnouts?
  - Bridges within limits for fire apparatus?
  - Drainage ditches/culverts?
  - Steep grades?
  - Is there a safe place to spot apparatus?

## CONSTRUCTION/CLEARANCE

- Does the structure have adequate defensible space, based on topography, fuels, and current and expected fire behavior?
- Can defensible space problems be mitigated quickly?
- Will building materials and yard clutter compromise safety?
- Is the construction wood siding or shake shingle roof?
- Are there vent openings, open eaves, large glass windows facing fire front, decks with vegetation below?
  - Will ember intrusion through attic or foundation vents be a problem?
- What are the contents in the garage and outbuildings?
- Are there hazardous materials present?
- Are there propane tanks, fuel tanks, or power lines?
- Is there an adequate water supply nearby?
- Are additional resources needed to mitigate issues?
- Consider "Prep and Go" or "Prep and Defend" tactics

## TIME CONSTRAINTS

- Is there time for an adequate size up of the structure defense problem?
- Is there time to mitigate safety concerns?
- Is there time and adequate resources to properly prepare and defend the structure?
- Is there time to escape, utilizing Escape Routes, to a Safety Zone? **If not, LEAVE NOW!**

## STAY OR GO

- Tactical decision based on the S-FACTS
- Is it safe to stay? If no, utilize "Check and Go" tactic
- Is there time to prepare the structure for defense and what will the fire behavior be when the fire gets here?
- "Prep and Go" or "Fire Front Following" tactics should be used when it is not safe to "Prep and Defend"

### STRUCTURE TRIAGE CATEGORIES

#### Not-Threatened

- Safety Zone nearby and TRA present at structure
- Construction features/defensible space make the structure unlikely to ignite
- Residents may/may not have evacuated

#### Threatened Defensible

- Safety Zone nearby and TRA present at structure
- Construction features/defensible space require structure defense tactics during fire front impact
- Residents may/may not have evacuated

#### Threatened non-Defensible

- Lack of adequate Safety Zone nearby
- Structure cannot be safely defended
- Residents must be evacuated

### ENTRAPMENT AVOIDANCE

- Are you adhering to the **10 Standard Firefighting Orders?** (IRPG)
- Have you considered the **18 Situations that Shout Watch Out?**
- Have you considered the **Common Denominators of Fire Behavior on Tragedy Fires?** (IRPG)
- Are you maintaining **LCES?** (IRPG)
- Look Up, Look Down, Look Around (IRPG)
- Have Decision Points ("Trigger Points") been established?
- Conduct Risk Management (IRPG)
  - Situational Awareness – Hazard Assessment – Hazard Control – Decision Point – Evaluate

## STRUCTURE DEFENSE TACTICAL ACTIONS

- **Check & Go** – Most appropriate action when no Safety Zone/TRA is present and fire front impact is imminent. Conduct rapid evaluation to check for occupants and evaluate for follow up action. **LEAVE promptly.**
- **Prep & Go** – Structure preparation can be safely completed prior to fire front impact. Potential fire activity is too dangerous to remain and/or there is no Safety Zone/TRA present. **LEAVE before escape routes are compromised.**
- **Prep & Defend** – Appropriate when a Safety Zone is nearby and TRA is present. Adequate time exists to prepare the structure for defense prior to fire front impact. Escape routes must be maintained.
- **Fire Front Following** – Follow-up tactic after passage of the fire front. Involves searching for victims, perimeter control, hot spotting, and ember control.
- **Bump & Run** – Resources move ahead of the fire front extinguishing spot fires and defending structures. Utilize extreme caution.
- **Anchor & Hold** – Resources use large volume fire streams to extinguish structure fires, stop structure-to-structure ignitions, protect exposures, and control embers.
- **Tactical Patrol** – Resources remain mobile and continuously monitor assigned area after fire front passage. Involves aggressive mop up around structures.

*Structure defense tactics are a vital part of perimeter control operations.*

- *Stopping fire spread significantly eliminates the fire's threat to structures.*
- *Connect contained points along the fire's perimeter – typically near the structures at risk ("Connect the Dots").*
- *Perimeter control and structure defense should be done concurrently.*

## LEVELS OF ENGAGEMENT

### Consider **PACE**

- **P** Primary Plan (Offense)
  - Focused on firefighter safety and objectives
- **A** lternate Plan (Offense)
  - Fallback plan that closely resembles primary plan
- **C** ontingency Plan (Defense)
  - Focused on firefighter safety, move to a safety zone, temporary refuge areas
- **E** mergency Plan (Defense)
  - Firefighter survival
    - Deployment zones/Refuge areas
    - Fire shelters

### Consider **DRAW-D**

- **D**efend – **R**einforce – **A**dvance – **W**ithdraw – **D**elay

## IMMEDIATE NEED EVACUATION CHECKLIST

- Co-locate with law enforcement at ICP
- Identify evacuation area utilizing local maps. Include area of incident potential when determining evacuation area.
- Identify traffic control points for entry and exit of resources and civilians
- Identify areas that must be immediately evacuated and label "evacuation order" areas
- Identify areas that are potentially threatened and label "evacuation warning" areas
- Identify community safe refuge areas inside evacuation areas
- Determine and publish evacuation routes
- Identify and clearly communicate the decision points for implementing additional evacuation areas
- Identify areas of special needs population and large animals
- Consider use of public notification systems for evacuations

## STRUCTURE DEFENSE FUNDAMENTALS

- Back equipment in for tactical mobility
- Shield apparatus from radiant heat – be aware of structure ignition potential
- Park in a cleared area (watch for power lines, trees)
- Have an engine/crew protection line identified
- Determine if residents are home. Determine best course of action – evacuate if safe to do so or shelter in place at safe location
- Maintain communications with all crew members
- Maintain at least 100 gallons of water reserve in your tank
- Top off your tank at every opportunity (use garden hose)
- For roof access, place owner's ladder at a corner of the structure on the side with the least fire threat and away from power drop
- Keep fire out of heavier fuels (suppress in lighter fuels)
- Clear area around above-ground fuel tank, shutting off tank
- Close windows and doors, including garage, leaving doors unlocked
- Place combustible outside furniture inside the structure
- Charge and place garden hoses strategically around structure for immediate use
- Move wood piles away from structures
- Consider applying foam/gel to the structure (roof and siding) and/or fuels
- **REMEMBER** to follow up with **TACTICAL PATROL!**



# METRO ZONE STRIKE TEAM CODE OF CONDUCT

## *When assigned to work as a member of a Strike Team or Task Force:*

1. I will treat all firefighters, officers, and the public with respect.
2. I will at all times conduct myself in a professional manner.
3. I will maintain a state of readiness when assigned, available and unassigned.
4. I will keep my supervisor informed of any issues that may impact my operational readiness or my ability to perform duties as assigned.
5. I will carry out orders as directed.
6. I am empowered to halt any unsafe or hazardous acts in which the risks outweigh the benefits.
7. I will respect the property of the residents I am protecting.
8. I understand that my actions are a reflection of the Metro Zone and my organization.
9. I will know which agency I am working for or providing support to.
10. I will communicate concerns, operational or otherwise, through my chain-of-command.
11. I will not transport or consume alcohol or illegal drugs.
12. I will not enter any residence without the owner's permission except to search or defend the structure or seek refuge when necessary. Unit leaders will leave a note at the residence detailing their actions and communicate their unit's activity through their chain of command.
13. I will maintain and wear all safety clothing as appropriate.
14. I will wear clothing that reflects my agency or as determined by the incident.
15. I will use normal radio procedures and keep radio traffic to a minimum.
16. I will know and comply with proper procedures and policies when assigned to commercial lodging for off shift rest.
17. I will be prepared to function unsupported for at least 24 hours.
18. I will have full turnouts for structure fires.
19. I will have all required wildland personal protective equipment.
20. I will limit the procurement of equipment to what is needed.
21. I will return all equipment issued at the incident before I am demobilized.
22. Violation of these rules may be grounds for dismissal from the ST/TF assignment.

Signature

Print Name

Rank/Position

Date



## PERSONAL STRIKE TEAM BAG

### CLOTHING

- Pants, Class B (2 Pair)
- Shorts, Class D (2 Pair)
- Shirts, Class B w/Hardware (2 Each)
- Shirts, Class C Short Sleeve (4 Each)
- Shirts, Class C Long Sleeve (2 Each)
- Shoes, Tennis (1 Pair)
- Shoes, Shower (1 Pair)
- Socks (6 Pair)
- Undergarments, ( 6 Each)

### PERSONAL PROTECTIVE EQUIPMENT

- Boots, Wildland (1 Pair)
- Brush Firefighting Jacket (1 Each)
- Brush Firefighting Pants (1 Each)
- Battery, Initial Replacement for Flashlight (1 Set)
- Flashlight (1 Each)
- Ear Plugs (Meets ANSI S3.9-1974) (2 Pair)
- Canteen (2 Each)
- Glasses, Safety Goggles (Meets ANSI Z87.1) (1 Each)
- Gloves, Wildland (1 Pair)
- Helmet, Brush with Shroud (1 Each)
- Helmet Lamp (1 Each)
- Lum-Stick (Chemical Lighting Device) (2 Each)
- Signal Mirror (1 Each)
- Personal Web Gear
- Whistle (1 Each)

### MISCELLANEOUS

- Sleeping Bag (1 Each)
- Bandana (2 Each)
- Chap Stick (1 Each)
- Glasses, Sun (1 Pair)
- Insect Repellent (1 Each)
- Medications, Prescription & non-prescription (Minimum 14-Day Supply)
- MRE & Snacks, high energy/ carbohydrates (Enough for 24-hours)
- Sunscreen (1 Each)
- Tissue, Small Pack (1 Each)
- Toiletry Kit (1 Each)
- Trash Bag (Rainproof Gear) (1 Each)
- Towel, Bath (1 Each)
- Toilet Paper (1 Roll)

### OPTIONAL ITEMS

- Books, Paperbacks
- Camera & Film
- Compass
- Knife, Folding (SOG Tool)
- Matchbox, Waterproof
- Sleeping Pad & Pillow
- Pen, Pencil & Notepad
- Radio, AM/FM w/headphone (situational/not allowed on aircraft)
- Sewing Kit, Small
- Tape, Duct Roll (6' rolled)
- Tent, Small 2-person (1 Each)
- Survival Blanket (PPE)
- Webbing, 1" nylon tubular, 20'

## I-ZONE PACK (DEPLOYMENT TIPS)

- Place bundle on ground in a clean circle
  - Male coupling must come from center of hose bundle and female from outside
  - Make sure hose does not become crossed or looped around other portions of bundle
- Remain at bundle when calling for water
  - Advancing an uncharged hose line will cause more kinks and delay water to nozzle
- Allow bundle to completely charge
  - Must have efficient water stream before advancing hose
  - Do not assist bundle while charging by flaking out hose, bundle charges best if left alone
- Traditional pump pressures have not been high enough to get the bundle to deploy effectively; the hose dept. is recommending that the 1<sup>st</sup> 100' length of hose with 3/8" tip be pumped at 100 psi. with two pounds of friction loss added for each additional 100' length of hose.





## I-ZONE PACK (BUNDLING TIPS)

- The first fold of hose should be 4 feet long
  - A consistent bundle size is required for proper deployment and storage in pack
- The first inline “T”, shutoff butt and nozzle should be placed on the male coupling of the 1<sup>st</sup> 100’ section of hose removed from pack
- The second “T” should be placed on the male coupling of the last 100’ section hose removed from pack
  - This configuration gives you the recommended 200’ spacing of inline “T’s”

Note: If inline “T’s” are placed on the female coupling you will lose the swivel action of the coupling



---

# HANDLINE CONSTRUCTION

---

SDFD is requiring that all vegetation fires within the department's response area will have handline constructed around the fire's perimeter to ensure containment measures are met. At the incident, handline is constructed around the perimeter, removing fuels such as brush, leaves, twigs and stobs (stumps of cut brush) to eliminate the possibility of the fire escaping and rekindle. The department has issued hand tools to all Type 1 and Type 3 apparatuses for use in handline construction. During suppression efforts, or once the fire has been knocked down, crews will work to construct handline down to BARE MINERAL SOIL. Once the handline is completed around the fire perimeter, the incident will be considered "contained."

## Handline Construction Considerations and Specifications:

- Use good body mechanics, and utilize the weight of the tool to help you do the work.
- Swing tools safely, and loudly call out "swinging" so others working near you are aware.
- Keep your tool's cutting edge sharp. A tool in better condition will be more efficient.
- Keep your spacing. Remember to "keep your dime," or 10 foot spacing while working.
- When hiking, carry your tool on the downhill side of your body with the tool head forward.
- Chainsaws are carried on the shoulder. Hand tools are carried on the side of the body.
- Handline width is determined by fuel type, loading, and arrangement. As these values increase, so does the width of the handline.
- Saw cut will be wider than the scraped handline (Ex. "6 foot cut, 2 foot scrape").
- Have an adequate anchor point.
- Keep the line as straight as possible, and widen out sharp turns ("dog legs") in the line.
- When swamping cut brush, ensure the burned vegetation is thrown into the black, and unburned vegetation is thrown into the green.
- Use trenches when constructing "under-slung line"- line constructed below the burn on a slope.

## Hand Crew Tool Order

1. Chainsaws/Brush Hooks
2. Pulaski
3. Rogue Hoe w/Pick
4. Rogue Hoe w/Rake
5. McCleod
6. Shovel

## Line Construction Methods

1. **Direct Attack** (Offensive)- Constructing handline on the immediate edge of the fire. This is the preferred method of line construction.
  - Minimizes burned area- no additional area is intentionally burned.
  - Safest place to work- firefighters can usually escape into the burned area, if needed.
  - The uncertainties of firing operations can be reduced/eliminated.
2. **Indirect Attack** (Defensive)- Constructing handline away from the fire's edge.
  - Control lines can be located using favorable topography.
  - Natural or existing barriers can be used.
  - Firefighters may not have to work in smoke and heat.
  - Control lines can be constructed in lighter fuels.
  - There may be less dangers of slop-overs.

3. **Parallel Attack-** Constructing handline with a small buffer from the fire's edge due to excessive heat.
  - Reduces the amount of radiant heat to firefighters.
  - Will eventually become direct line once fire burns through buffer.
  - Access to safety zone in clean burn still potentially available.

**Blackline Policy-** “One foot in the black, one foot in the green”. This policy allows you to carry your safety zone with you as the line progresses, as long as there is no re-burn potential in the burned area.

**Downhill Line Construction-** Hazardous in steep terrain, fast-burning fuels, or rapidly changing weather. It should NOT be attempted unless there is no tactical alternative. When building fireline downhill, the following must be considered:

- Discuss assignments with all supervisors and fireline overhead before committing to the task. The responsible overhead must be Task Force Leader or IC Type 4 qualified, and must stay with the job until completed.
- Scout the proposed fireline prior to engaging for viability.
- LCES must be established.
- Utilize direct attack whenever possible. If not possible, the fireline must be completed between to anchor points before being fired out.
- Fireline will not lie in or adjacent to a chute or chimney.
- Starting point will be anchored for crews building fireline down from the top.
- Monitor the bottom of the fire- if potential exists for the fire to spread, take action to secure the fire edge.

**Fire Behavior Hauling Chart-** A graphic aid that illustrates different management and control types based on two primary characteristics of fire behavior- rate of spread and fire intensity. Handline construction is generally only effective with flame lengths of 4 feet or less. The chart can be referenced in the IRPG and the Fireline Handbook.

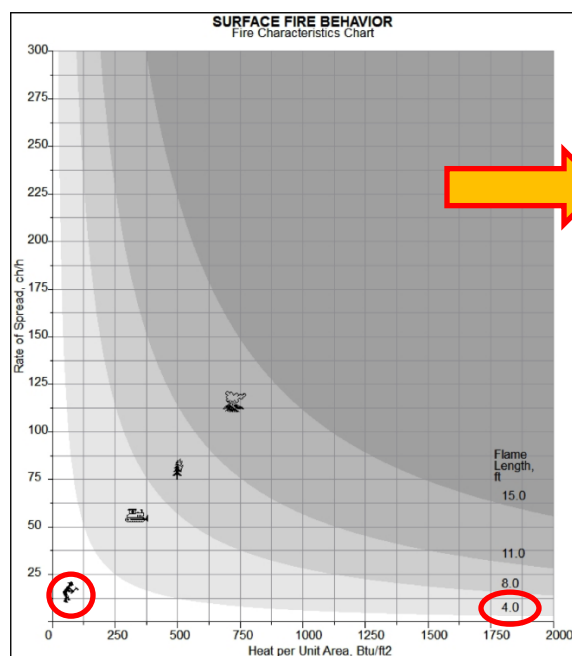

**Fire Behavior Hauling Chart**  
Tactical Interpretations from Flame Length

Flame Length	Interpretations
<b>Less than 4 feet</b>	Fires can generally be attacked at the head or flanks by firefighters using hand tools. Handline should hold fire.
<b>4 to 8 feet</b>	Fires are too intense for direct attack on the head with hand tools. Handline cannot be relied on to hold the fire. Dozers, tractor-plovers, engines and retardant drops can be effective.
<b>8 to 11 feet</b>	Fire may present serious control problems: torching, crowning, and spotting. Control efforts at the head will probably be ineffective.
<b>Over 11 feet</b>	Crowning, spotting, and major fire runs are probable. Control efforts at the head of the fire are ineffective.

# FIRE SHELTER SURVIVAL

## *Do's and Don'ts That Could Save Your Life*

This is an extract from [www.wildfirenews.com](http://www.wildfirenews.com).

Fire shelters have saved the lives of more than 270 firefighters. Countless serious injuries have been prevented by using shelters on the fire line.

But 28 firefighters who were carrying shelters have died, some because they didn't get their shelters out of the cases, and others because they didn't know how to safely use them.

Ted Putnam, a specialist in protective clothing and equipment at the U.S. Forest Service's Missoula Technology & Development Center, explains that many firefighters who once considered the fire shelter just excess baggage have survived entrapments because they used their shelters.

But **training and practice are critical**. Six firefighters died in 1990 when their escape plans failed and the fire caught them before they could deploy shelters. It can take an untrained person several minutes to get into a shelter, but practice sessions can cut that to **20 seconds or less**.

**Shelter training should include deployments under turbulent conditions**, because high winds associated with the arrival of a flame front can rip a shelter away from you. Keep an arm or leg through the shelter strap so it's not blown away. "We have some footage from a practice exercise," says Putnam, "where firefighters were deploying fire shelters under very windy conditions. The shelters would wrap around people and blow between their legs."

**Practice removing the shelter from the case while running**. Firefighters have died because they couldn't get their shelters out while trying to outrun a flame front. Putnam says on-the-run practice may have saved some lives on the Dude Fire, where seconds mattered.

"In this case, the fire came and split that crew in half. If they'd run without their packs, they would have all made it out the bottom. When that finger split some of them off, though, they turned around. When they did, one of them remembered, 'Oh boy, we're cut off now and we've got to get into our fire shelters.' But he couldn't reach his shelter and get it out with one hand; he had to take his pack off to get his shelter out. Then he looked up the road and saw there was fire between him and the other people, who had spun around and started back up the road. He deployed right there. He didn't have any problem because he got into it right away, before the area between the two fingers closed in on him. The other people were running uphill with their packs on, yelling, 'Get your fire shelters!' But they couldn't get them, because the lid for the shelters was in their center back area and their packs kept hitting down on the lids. They'd start to lift, and then the pack would come down on their hand."

"As they continued up the road," he says, "they came to a steep pitch. They were exhausted, so they stopped. The first six people there got into their shelters. One of the people in the upper six

said later that when he was going under his shelter the other people were just starting to get their shelters unfolded when the fire caught them. All the physical evidence very clearly indicated something like the fire catching them prior to getting under their shelters."

**Once you get into a shelter, you should prepare yourself mentally to stick it out.** Keep your nose to the dirt and don't get out.

"On the Dude fire one guy got out right when the flames got there," Putnam says. "I think he yelled, 'I'm being burned.' The people there in shelters next to him said that's the time that the shelter material started to heat up. He jumped up and started down the road, and he hit someone else's shelter and knocked a hole in it, which allowed hot air to get in. It wasn't too long after he got up that another firefighter got up. He survived, but was burned pretty badly as he went up the road. He should have stayed put. The hotshots up above saw him coming and rescued him. He was dragging his shelter on the ground, and if he'd held it over his back as a shield he would have probably come out of it in pretty good shape."

Putnam explains that the clothing on one firefighter they examined did not suffer the damage that would be expected when someone is overrun by flames. "His clothing looked good compared to a lot of people who were burned and survived," says Putnam. "He got out of his fire shelter, and apparently was dragging his shelter on the ground. We found a trail of fire shelter material. He picked up a lot of radiant burns from walking around in the hot air. Because we found huge pieces of shelter material later, this indicates the fire shelter had done its job during the flame passage. We think if he had just stayed in place, the shelter would have kept providing protection."

**It's important in an entrapment that firefighters stay down on the ground.** "Once you're up off the ground," says Putnam, "hot gases can come under the shelter and right up into your face. We warn people to stay out of chimneys, but when you stand up, you in fact become a chimney. When fire gets around a human body it will just run right up into your face, which is the worst place you can have it come."

Research by Putnam and Bret Butler of the Fire Sciences Lab of the Intermountain Research Station, also at Missoula, indicates that the difference in air temperature close to the ground and just a short distance above the ground could be significant for survival. They found in testing fire shelters set up in prescribed burns that air temperatures increase at a rate of 9°F. per inch rise above the floor of the shelter. Findings from these studies are reported in a to-be-published paper.

**If you have to get in with someone else and share a shelter, be sure you let them know you're trying to get in.**

"On the Buchanan Burn," says Putnam, "one firefighter was having trouble getting into his shelter. Another was fully deployed on the ground, and the edge of his shelter started to lift up. He grabbed it and held it down -- which is what we recommend you do -- but it turns out it was one of his fellow firefighters trying to get in."

"The fire shelter, when we found it, had a huge tear in it," he says. The firefighters said later they thought they'd torn it when they were wrestling with it. Putnam recommends that firefighters yell, "Can I get in?" if they have to share.

"I think most people are going to let you in," says Putnam. "The problem is when they don't know what's out there."

**Water can make the difference in an entrapment, but only if you drink it. Don't try to wet down your skin, your clothes, or your bandanna.** Wet clothing conducts heat to the skin five times faster than dry clothing, and moist hot air will damage airways and lungs sooner than dry air will.

"If you go into a steam room, 130 degrees is about as hot as you can stand it," says Putnam. "In a dry sauna, though, you can take 180 degrees. You can tolerate hot dry air better than moist air."

**Of course the best way to survive a burnover is to avoid one.** Pick out safety zones in advance, and make sure your escape route is good. Exercise **L.C.E.S.**

"At South Canyon, people ran through survival zones," says Putnam. "They went into the East Canyon, and there were spot fires in it as they were going down. It was just touch and go to get below them, and 15 minutes after they got out of there, the canyon went up."

The fire at South Canyon came through a saddle, and firefighters had planned a longer path out -- the way they'd come in. "When the fire burned into that area," says Putnam, "they turned around and headed straight out. I think they got out of there probably 20 or 30 minutes faster than they would have with the other plan. That could in fact have saved some lives. They were regressing back to a known route, rather than seeing clearly the need for the fastest route out."

"We talked to everybody," he says, "and they didn't have a clue where they could deploy a fire shelter. I don't know how many people I talked to, and I asked them if they'd ever read the literature on shelters. Most weren't even aware of it. Prior to South Canyon most firefighters' only training was practicing getting into a shelter."

Failure to choose a safe site for deployment can be fatal. In an entrapment on Montana's Shepard Mountain Fire, firefighters deployed on a sidehill rock slide.

"These people were in a rock slide safety zone for more than an hour and a half before the fire got there," says Putnam. "One person was burned there after he deployed his shelter near some brush. They were probably waiting, waiting, waiting, and they didn't do anything until the fire was right there. And maybe at the last minute it came a little too quick."

**If you think you may be trapped or overrun, ditch the fusees.** They will autoignite at 375 degrees, which is about 50 degrees hotter than the melting point of goggles and hardhats, a temperature that's common under escape conditions.



"They're the most dangerous things firefighters carry," says Putnam. "There was a firefighter who died without extensive burn injuries. Looking at his clothing, it appeared that he should have survived." So what killed him? It became apparent during the investigation that a possible cause of the problem was in the backpack. The body was found face down, with the burned backpack on the firefighter's back.

"A fusee or fusees had ignited in the pack," explains Putnam, "and burned a hole into his back. The fusees could not be ruled out as a cause of death. If you're carrying fusees and time is running out, it's another reason to drop your pack."

Perhaps one of the most critical survival skills is one that's most difficult to actually do on a fire. In the last seven years, 23 firefighters have died carrying packs and tools while running uphill from a fire. **If you're going to escape, you have got to get your shelter out, drop your packs, and run.** You're up to 20 percent faster without your gear. Most of these fatal entrapments, according to Putnam, could have been survived if firefighters had dropped their gear and run with only their shelters. At South Canyon no firefighters dropped packs; two dropped their tools only when they started to get burned.

"If they'd dropped their packs," says Putnam, "the projection shows that they all make it. Scott Blecha was the last one to make a run for it. When he left the crew, if he had run without his pack, chances are good he would have made it. Three people made it up over the top of the ridge -- the first one over just had light radiation burns, like sunburn, and the second one had second-degree burns, and the third one had third-degree burns. And Scott Blecha wasn't that far behind those people."

"Firefighters on the Dude Fire saw the fire coming over the top of the ridge," Putnam says. "Their escape route was down the road. They all had their packs on, and as they ran down the hill, one of them saw that the person ahead of him was running with a chainsaw. He ran up next to him and said, 'Get rid of that damn chainsaw!' When the guy wouldn't do it, he grabbed it away from him. But when they finally got to the road, he still had the chainsaw in his hand."

Putnam says even though one of the firefighters saw it was possible to run faster without the saw, once he got hold of it, he held on to it. "It showed, from a human factors standpoint, that your equipment becomes an extension of yourself -- it almost becomes invisible -- and it's very hard to let go," says Putnam.

The best way to avoid an entrapment, of course, is to not get into an area where it'll happen. **But the best thing you can do to survive one, should you get caught, is to be prepared. Read the books, know the material, get the training.**

"We need to be more aggressive about our training," Putnam says. "We need to make sure that people not only go to the classes, but then we need to talk to them. We're trying to encourage crew leaders and safety officers to spot-check fire shelters, and ASK people questions about fire shelters, to see whether they know that material. Training is one thing, but then we need to ask: did the training take? We know that this critical information must be *overlearned* to be available when you're under the mental stress of a fast-moving flame front."

Chances of surviving an entrapment have increased from under 50 percent to about 98 percent since agencies made fire shelters mandatory equipment. In the last 17 years, though, we've lost 28 firefighters who were carrying fire shelters. Why? Half these people didn't remove their shelters from the cases. Eight others were critically burned before they could get under their shelters. Three of them got out of their shelters instead of staying put. Most of these people could have survived if they'd known and followed the guidelines for shelter deployment.

You have a proven life-saver. Learn how to use it effectively! Carry it. Fight fire safely, so you don't *need* to use the shelter. Use **LCES, 10 standard FIRE ORDERS, 18 situations that shout WATCHOUT and communicate facts**. Remember that it *can* happen to you. If it does, proper use of a fire shelter can save your life.

For further information, contact:  
Missoula Technology & Development Center  
Building 1 Fort Missoula  
Missoula Montana 59804  
(406)329-3965

# WILDLAND ABBREVIATED GUIDE

- Initial report
  - Size of fire
  - Fuels involved (grass, brush, timber, etc)
  - Fire location
  - Rate of spread (creeping, running, spotting, crowning)
  - Additional info
    - Best access
    - Values threatened
    - Additional resources needed
  - Assume role of Incident Commander
  - Example: “San Diego, E10 at scene of a 2 acre brush fire on the north slope, adjacent to the address, with a moderate rate of spread. Make this a 2<sup>nd</sup> alarm. Have the 2nd alarm units respond to the street north of my location. E10 assuming University IC.”
  - Remember, FCC and other responding units only know what is going on by what the first unit at scene tells them.
  
- Provide for FF safety
  - **The Risk Management Process**
    - Situation Awareness – gather info, objectives, etc.
    - Hazard Assessment – identify/eliminate potential hazards/Watch Out situations (see “Look Up, Look Down and Around Indicators)
    - Risk Control – 10 FIRE Orders, LCES, create anchor point
    - Evaluate – personnel, situation, strategy/tactics
  
- Safety Zones
  - For radiant heat only, the distance separation between the FF and the flames must be at least 4 times the maximum flame height on all sides, if the fire has the ability to burn completely around the safety zone. (Convective heat from wind and/or terrain influences will increase this distance requirement.)
  - Find a survivable area
    - Stay out of hazardous terrain
    - Use bodies of water that are more than 2 feet deep
    - Call for helicopter or retardant drops
  - Do not travel in direction of fire spread unless **certain** a safe spot can be reached
  
- Fire Shelter Deployment Expectations
  - Extremely heavy ember showers
  - Noise and turbulent powerful winds hitting the fire shelter
  - Pin holes in the fire shelter that allow fire glow inside
  - Heat inside the shelter = Extreme heat outside
  - Deployments have lasted up to 90 minutes
  - When in doubt, wait it out

- **Driving Limitations**
  - No driver will drive more than 10 hours (behind the wheel) within any duty day
  - Drivers shall drive only if they have had at least 8 hours off duty before beginning a shift.
  - **Exception to the minimum off-duty hour requirement to:**
    - Accomplish immediate and critical suppression objectives
    - Address immediate/critical FF or public safety issues
    - Documentation of mitigation measures used to reduce fatigue is required for drivers who exceed 16-hour work shifts. This is required of whether the driver was still compliant with the 10-hour individual (behind the wheel) driving limitation.
  
- **Safety Flagging Standards**
  - Yellow-black striped ribbon denotes hazards
    - If feasible, write nature of hazard on ribbon (snags – 200 feet up slope)
    - Remove when hazard is abated
  - Hot pink marked “escape route” in black lettering (escape routes and safety zones)
  
- **Aerial Retardant/Bucket Operations**
  - Personnel can be injured by the impact of retardant/water dropped by aircraft. Direct personnel to clear out of target area when drop is to be made. If an individual is unable to retreat to a safe place, the safest procedure to minimize injury from the drop is to:
    - Hold on to your hand tool away from your body
    - Lie face down, with head toward oncoming aircraft and hard hat in place
    - Grasp something firm to prevent being carried or rolled about by the dropped liquid
    - Do not run unless escape is assured
    - Get clear of dead snags, tops, and limbs in drop area
    - Working in an area covered by wet retardant or Class A foam should be done with caution due to slippery surfaces
    - Wash retardant or Class A foam off skin to prevent possible skin irritation
  - Give feedback to pilot about drop accuracy. Be honest and constructive. Let the pilot know if drop was early, late, uphill, downhill, on target too high, or too low.
  
- **Water Use Guidelines**
  - Keep at least 100 gallons of water reserve in your tank
  - Top off tank at every opportunity; use garden hose
  - Draft from swimming pool, hot tub, or fish pond
  - **STAY MOBILE**; do not hook up to hydrant except to refill tank
  - **CONSERVE WATER**; apply water only if it controls fire spread or significantly reduces heating of structure being protected
  - Use foam or other water additives to increase effectiveness and save water

- Structure Triage Guidelines
  - An attempt to save a structure may be unsuccessful or too dangerous if:
    - There is no safety zone and refuge available
    - There is no place to park an engine safely
    - Fire is making a sustained run and there is little or no clearance (natural fuels are 30 feet or closer to structures)
    - Fire behavior is extreme: spot fires are numerous and outpacing control (includes strong winds and slopes  $\geq 30\%$ )
    - Water supply will not last as long as the threat
    - Roof is more than  $\frac{1}{4}$  involved
    - Fire has involved the interior of the structure, windows are broken, and conditions are windy
    - Crew cannot safely remain at the structure and/or the escape route could become unsafe to use
    - If a structure becomes well involved, leave it and move on to one that can be saved
  
- Preparing Structure
  - Determine if residents are home (legal responsibility for evacuation lies with law enforcement). If residents remain on-scene, advise them to use structure if it's safe to do so as a refuge when fire arrives.
  - For roof access, place owner's ladder at a corner of structure on side with least fire threat and away from power drop.
  - Clean roof of leaves, needles, and any other combustible materials
  - Remove and scatter away from structure:
    - Overhanging limbs
    - Ground/ladder fuels to prevent fire from moving into crowns
    - Wooden fences and wood piles near structure
  - Clear area around above-ground fuel tank, shutting off supply
  - Place combustible outside furniture inside structure
  - Close windows and doors (including garage), leaving them unlocked. AS A LAST RESORT, YOU MAY NEED TO USE STRUCTURE AS REFUGE.
  - Have garden hose(s) charged and place strategically around structure for immediate use.
  
- How to Properly Refuse Risk
  - Every individual has the right and obligation to report safety problems and contribute ideas regarding their safety. Supervisors are expected to give these concerns and ideas serious consideration. When an individual feels an assignment is unsafe, they also have the obligation to identify, to the degree possible, safe alternatives for completing that assignment. Turning down an assignment is one possible outcome of managing risk.
  - A "turn down" is a situation where an individual has determined they cannot undertake an assignment as given **and** they are unable to negotiate an alternative solution. The turn down of an assignment must be based on an assessment of risks and the ability of the individual or organization to control those risks.

- Individuals may turn down an assignment as unsafe when:
    - There is a violation of safe work practices
    - Environmental conditions make the work unsafe
    - They lack the necessary qualifications or experience
    - Defective equipment is being used
    - Individuals will directly inform their supervisor that they are turning down the assignment as given. The most appropriate means to document the turn down is using the criteria (Standard Firefighting Orders, 18 Watch Out situations, etc.) outlined in the Risk Management Process.
    - Supervisor will notify the Safety Officer, Section Chief, or IC
  - Notification of the turn down provides accountability for decisions and initiates communication of safety concerns within the incident organization.
    - If the supervisor asks another resource to perform the assignment, they are responsible to inform the new resource that the assignment has been turned down and the reasons that it was turned down.
  - These actions do not stop an operation from being carried out. This protocol is integral to the effective management of risk, as it provides timely identification of hazards to the chain of command, raises awareness for both leaders and subordinates, and promotes accountability.
- Miscellaneous points
    - Do not cross the fire's head unless it can be done safely!
    - When fires make hot runs upslope, it is safer to draw back to the flanks and let the fire cross the road than to attempt a frontal assault.
    - Keep the fire from spreading into heavier or more dangerous fuels; extinguish fire at its lowest intensity
    - Keep the fire isolated on one side or in a single canyon or drainage.
    - Mark entrance to long driveways to show that protection is in place (*very important* when structure cannot be seen from the road)
    - Keep egress route clear
      - Back equipment in for quick escape
      - Park extra equipment on street
      - Keep hose off driveway
    - Coil a short 1-3/4" charged line with fog nozzle on your engine for safety and quick knock-down
    - Do Not make long hose lays
    - Start mop-up as soon as line construction and burnout operations are completed. In an urban area, all material inside the line needs to be extinguished and mopped up to prevent a rekindle, possible escape, and to prevent further responses to the same fire.



## Look Up, Look Down and Look Around Indicators

Fire Environment Factors	Indicators
Fuel Characteristics, Assess	Continuous fine fuels Heavy loading of dead and down Ladder fuels Tight crown spacing (<20 ft.) Special Conditions: <ul style="list-style-type: none"> <li>• Firebrand sources</li> <li>• Numerous snags (high dead to live ratio)</li> <li>• Preheated canopy</li> <li>• Frost and bug kill</li> <li>• Unusual fine fuels</li> </ul>
Fuel Moisture, Feel and Measure	Low RH (<25%) Low 10 hr FMC (<6%) Drought conditions Seasonal drying
Fuel Temperature, Feel and Measure	High temps (>85F) High % of fuels w/ direct sun Aspect fuel temp. increasing
Terrain, Scout	Steep slopes (>50%) Chutes – chimneys Box canyons Saddles Narrow canyons
Wind, Observe	Surface winds above 10 mph Lenticular clouds High, fast-moving clouds Approaching cold fronts Cumulonimbus development Sudden calm Battling or shifting winds
Stability, Observe	Good visibility Gusty winds and dust devils Cumulus clouds Castellatus clouds in the a.m. Smoke rises straight up Inversion beginning to lift Thermal belt
Fire Behavior, Watch	Leaning column Sheared column Well-developed column Changing column Trees torching Smoldering fires picking up Small fire whirls beginning Frequent spot fires

## WHAT THE COLOR AND COLUMN OF SMOKE MAY MEAN

What you see	What it may mean
Widening at the base; predominantly white, but starting to turn brown or black on its downwind side	May indicate fire is spreading in grass and moving to heavier fuels. Dead brush will turn brown; brush with higher oil content will burn black.
Thick and black with no spread to the base	Could be a structure or vehicle fire; may also be tires.
Black, but some white or light brown is showing away from the main column	May mean a vehicle or structure fire has moved into grass
Column is going straight up	Little or no wind on the fire
Column is going up, but top of smoke is bent over	Little surface wind, but there is wind where the smoke bends. Beware: that wind may appear at any time.
Bent over at the ground and building in volume and intensity	Fire is wind-driven with a good fuel supply
Has built to several thousand feet and a small white cloud has formed at the top	Don't plan on days off. You are going to be quite busy.

# **THE ABBREVIATED GUIDE TO INCIDENT COMMAND**

## **(For Vegetation Fires in the Urban Environment)**

Compiled by J. H. Jondall, 07-20-04

### **OBJECTIVES:**

- Provide for fire fighter safety.
- Evacuate endangered occupants and treat the injured.
- Control, Confine, and extinguish the fire.
- Conserve property during and after fire control operations.

### **DUTIES OF THE INCIDENT COMMANDER:**

1. Assume an effective command position
2. Transmit a brief initial radio report
3. Provide for fire fighter safety
4. Rapidly evaluate the situation (size-up)
5. Assign units as required and develop a tactical plan
6. Request and assign additional units as required
7. Provide continuing incident command and progress reports until relieved
8. Review and evaluate control/attack efforts and revise attack plan as appropriate
9. Mop up
10. Rehab and return companies to service

### **1. ASSUME AN EFFECTIVE COMMAND POSITION**

- Position the command post in a predictable and conspicuous location, which also affords a reasonable degree of safety and provides the IC with a good view of the fire and surrounding area

### **2. TRANSMIT A BRIEF INITIAL RADIO REPORT**

- Fire location – "north slope of Bald Mt, near lower campground"
- Give incident a name
- Terrain (slope, aspect, elevation) and position of fire on the slope
- Size of fire
- Assume role of Incident Commander
- Other jurisdiction(s) involved (State, USFS, BLM, and Local Fire Dept./Agency).
- Incident size– "less than 1 acre"
- Fuels involved (grass, brush, timber, etc.)
- Wind speed and direction
- Rate of spread (creeping, running, spotting, crowning)
- Best access– "Farm Road off main highway"
- Special hazards or concerns – "down power lines, mining claims in area"
- Values threatened – "housing tract within ½ mile of fire"
- Additional resource needs

- Other Considerations:
  - Fire name and location
  - Fuel type, anticipated control problems, and spread potential
  - Values threatened
  - Weather conditions (wind speed and direction)
  - Fire behavior
  - Resources on the fire and those needed
  - Estimated containment and control times
  - Cause (known, suspected, under investigation)
  
- After your initial size-up of the fire and/or transition from an initial attack IC, answer the following questions:
  - Have you sized up the fire and relayed the information to dispatch?
  - Is the observed fire weather consistent with the forecast?
  - Can you control the fire with the resources available (on the incident or soon to be on the incident) and under the expected conditions?
  - Have you developed a plan to attack the fire (direct or indirect, anchor points, escape routes, head or flank attack, priority areas); and have you communicated this information to all personnel assigned to the incident, including new arrivals?
  - Are lookouts in place or can you see all of the fire area?
  - Can you communicate with everyone on the fire and with dispatch?
  - Are escape routes and safety zones established? If you are using the black, is it completely burned and without a re-burn potential?
  - Are safety and the standard fire orders being followed?
  - Do you have a complete list of what resources have been ordered for the fire?
  - Will you control the fire before the next operational period; and if you won't, or the size of the organization exceeds the IC's capability to manage, have you informed the agency Fire Management Officer?
  
- Remember, Fire Communications and the other responding units only know what is going on by what the first unit at scene tells them
- Be brief, take a moment to compose your transmission mentally before you key the mike
- Repeat this analysis whenever there is a change, or predicted change, in conditions on the fire

### **3. PROVIDE FOR FIREFIGHTER SAFETY- Briefing**

Incident Commanders, supervisors, and firefighters must ensure that safety factors are covered with incident personnel at all operational briefings and that safety briefings occur throughout the fire organization.

Safety factors should include the following:

- Define assignment
- Address basic firefighter safety and health issues
- Apply the five-step Risk Management Process

#### **The Risk Management Process**

##### **Step 1 - Situation Awareness**

- Gather Information
- Objective(s)
- Previous Fire Behavior
- Communication
- Weather Forecast
- Who's in Charge
- Local Factors
- Scout the Fire

##### **Step 2 - Hazard Assessment**

- Eliminate Potential Fire Behavior Hazards
- Look Up, Down and Around Indicators (see table below)
- Identify Tactical Hazards
- Watch-Outs Situations
- What other safety hazards exist?
- Consider severity vs. probability

##### **Step 3 – Risk Control**

- Firefighting Orders → LCES Checklist –MANDATORY
- Anchor Point
- Downhill Checklist (if applicable)
- What other controls are necessary?

##### **Step 4 - Decision Point**

- Are controls in place for identified hazards?
  - NO – Reassess situation
  - YES – Next question
- Are selected tactics based on expected fire behavior?
  - NO – Reassess situation
  - YES – Next question
- Have instructions been given and understood?
  - NO – Reassess situation
  - YES – Initiate action

## Step 5 – Evaluate

- Self:
  - Low experience level with local factors?
  - Distracted from primary tasks?
  - Fatigue or stress reaction?
  - Hazardous attitude?
- The Situation: What is changing?
  - Are strategy and tactics working?

### **Fire Weather Forecast**

Forecasts reflecting general weather changes, as well as local weather affecting the immediate fire area should be studied, understood, and used by overhead on the fire. Disseminate to all fireline personnel. NOAA Weather Radio forecasts should not be substituted for fire weather forecasts. NOAA Weather Radio may not broadcast fire weather forecasts, only forecasts directed to the general public. Spot weather forecast should be requested for fires that have potential for extreme fire behavior, exceed initial attack, or located in areas for which a **FIRE WEATHER WATCH** or warning has been issued.

### **Fire Danger Rating**

Know and understand locally accepted Fire Danger Rating Indices and components. Find out what this season's trends are doing compared to the historic average and historic maximums.

### **Safety Precautions under Extreme Fire Behavior**

- Be alert to indicators of sudden weather changes
- Trees torching out inside fireline
- Smoldering fires beginning to burn actively
- Approaching thunderheads with dark clouds beneath
- Presence of dust devils and whirlwinds
- Increased spotting
- Sudden calm
- High clouds moving fast in direction different from surface wind

### **Be Aware of "Watch Out" Working Situations**

- Building fireline down into where the fire is burning
- Building fireline on hillside beneath fire
- Building fireline through heavy cover at considerable distance from fire
- Building fireline in country not seen in daytime



## **Have Clear-Cut Plan of Action for Potential Extreme Fire Behavior Conditions**

- Advise personnel of escape routes and make necessary provisions to ensure the route is clearly marked and accessible for foot or vehicle traffic
- Give crew frequent rest periods, making sure adequate amounts of water are consumed
- Ensure chain of command and firefighter accountability system are in place
- Know location of rockslides, open hillsides, streams, etc.
- Post lookouts to alarm firefighters who are working where they cannot directly observe danger points (fire behavior, rolling material, etc.)
- Consider possibility of retreating into burn
- When crossing fire edge into burn, have crew protect faces and hold breath, if possible
- Do not travel in direction of fire spread unless certain a safe spot can be reached
- Carry fuses to burn out "safety zones"

## **Safety While Protecting Structures from Wildland Fires**

Structures exposed to wildland fire in the urban interface can and should be considered as another fuel type. Size-up and tactics should be based upon fuels, weather, and topography, just as those criteria would be applied to a wildland fire.

## **LCES Checklist**

In the wildland fire environment, Lookouts, Communications, Escape Routes, Safety Zones (LCES) are keys to safe procedures for firefighters. This system is put in place before fighting the fire: select a lookout or lookouts, set up a communication system, choose escape routes, and select safety zones.

## **LCES IS A SELF-TRIGGERING MECHANISM**

Lookouts assess and reassess the fire environment and communicate threats of safety to firefighters. Firefighters use escape routes to move to safety zones. LCES is built on two basic guidelines:

- Before safety is threatened, each firefighter must be informed how the LCES system will be used
- The LCES system must be continuously reevaluated as conditions change

## **Escape Routes and Safety Zones**

- An Escape Route is "A pre-planned and understood route firefighters take to move to a Safety Zone or other low-risk area."
- A Safety Zone is "a preplanned area of sufficient size and suitable location that is expected to protect fire personnel from known hazards without using fire shelters."
- Identification of Escape Routes and Safety Zones is one of the primary responsibilities of any firefighter working on or near the fireline. The following guidelines can be used when selecting Safety Zones:
  - Calculations indicate that for most fires, Safety Zones must be wider than 164 feet to ensure firefighter survival
  - The calculation to determine Safety Zone radius is four times the maximum flame height plus 50 square feet per firefighter, or an additional four feet of radius per firefighter
  - If a potential for the fire to burn completely around the Safety Zone exists, the diameter

- Factors that will reduce Safety Zone size include reduction in flame height by thinning or burnout operations, shielding the Safety Zone from direct exposure to the flame by locating it on the lee side of ridges or other geographic structures, or reducing flame temperatures by applying fire retardant to the area around the Safety Zone
- All PPE must be worn
- Keep in mind that these guidelines do not address convective energy

### Safety Zone Guidelines

- Avoid locations that are downwind from the fire
- Avoid locations that are in chimneys, saddles, or narrow canyons
- Avoid locations that require a steep uphill escape route
- Consider traffic, road conditions, and travel distance if engine crews must drive to safety zones
- Take advantage of heat barriers such as lee side of ridges, large rocks, or solid structures
- Burn out safety zones prior to flame front approach
- For radiant heat only, the distance separation between the firefighter and the flames must be at least 4 times the maximum flame height. This distance must be maintained on all sides, if the fire has ability to burn completely around the safety zone
- **Convective heat from wind and/or terrain influences will increase this distance requirement. The calculations in the following table assume no slope and no wind**

Flame Height	Distance Separation (Firefighters to flame)	Area in Acres
10'	40'	1/10 acre
20'	80'	1/2 acre
50'	200'	3 acres
75'	300'	7 acres
100'	400'	12 acres
200'	800'	50 acres

*Distance Separation is the radius from the center of the safety zone to the nearest fuels. When fuels are present that will allow the fire to burn on all sides of the safety zone this distance must be doubled in order to maintain effective separation in front, to the sides, and behind the firefighters. **Area in Acres is calculated to allow for distance separation on all sides for a three-person engine crew.** One acre is approximately the size of a football field or exactly 208 feet x 208 feet.*

**Last Resort Survival**

- Look at your options and immediately act on the best one!
- Utilize all Personal Protective Equipment!
- Protect your airway!

**Escape if you can:**

- Drop any gear not needed for fire shelter deployment (keep your fire shelter, hand tool, quart of water, and radio)
- You may be able to use the fire shelter for a heat shield as you move
- In LIGHT FUELS, you may be able to move back through the flames into the black.
- If you are on the flank of the fire, try to get below the fire
- Consider vehicles or helicopters for escape

**Find a survivable area:**

- Stay out of hazardous terrain features
- Use bodies of water that are more than 2 feet deep
- In LIGHT FUELS, you may be able to light an escape fire
- In other fuels, you may be able to light a backfire
- Call for helicopter or retardant drops
- Cut and scatter fuels if there is time
- Use any available heat barriers (structure, large rocks, and dozer berms)
- Consider vehicle traffic hazards on roads

**Pick a fire shelter deployment site:**

- Find the lowest point available
- Maximize distance from nearest aerial fuels or heavy fuels
- Pick a surface that allows the fire shelter to seal and remove ground fuels
- Get into the fire shelter before the flame front hits
- Position your feet toward the fire and hold down the fire shelter
- Keep your face pressed to the ground
- Deploy next to each other and keep talking

**Expect:**

- Extremely heavy ember showers
- Superheated air blast to hit before the flame front hits
- Noise and turbulent powerful winds hitting the fire shelter
- Pin holes in the fire shelter that allow fire glow inside
- Heat inside the shelter = Extreme heat outside
- Deployments have lasted up to 90 minutes
- When in doubt wait it out

## **FIREFIGHTER HEALTH**

### **Fatigue – Work and Rest**

- Establish record-keeping systems that track crew work time
- Plan and strive to provide one hour of sleep or rest for every two hours worked
- When deviating from work/rest guidelines, the agency administrator or incident commander (IC) must approve in writing
- Start each operational period with rested crews
- Provide an adequate sleep environment
- Monitor individuals for sleep deprivation

The pulse is a good way to gauge fatigue. The pulse should recover in one minute or less to 110 beats per minute, or, if not, a longer break is needed. A firefighter's wake-up pulse can signal potential problems. If it is 10% or more above normal, it can mean fatigue, dehydration, or even a pending illness.

### **Food and Nutrition**

Nutritious food can be a morale booster, but more importantly, it fuels muscles for hard work and internal organs for health and fitness. A firefighter may burn 5,000 to 6,000 calories a day. These calories must be replaced to avoid cramping, fatigue, and impaired judgment. Government provided food must be low in fats and high in complex carbohydrates. Drinks provided must replace essential fluids lost from the body during exercise. On a normal fireline assignment, firefighters may replace 12 or more quarts of fluids a day. In some cases, firefighters may need to replace one to two quarts of fluids per hour. Water is an excellent way to replenish fluid loss. Natural juices and sport drinks contain energy-restoring glucose. Avoid caffeinated, carbonated, and "diet" drinks.

### **Firefighter Rehabilitation**

Areas designed for resting, eating, and sleeping should be located in a safe, shady area away from smoke, noise, running fire, falling trees and snags, rolling rocks, moving vehicles, aircraft, and pack stock. Provide reasonable rest periods, especially at high elevations and on hot days.

### **Driving Limitations**

Drivers operating vehicles that require a Commercial Drivers License (CDL) are regulated by the Federal Motor Carriers Safety Regulations Part 393.3 and any applicable State Laws. All governmental fire agencies are exempted from several requirements of CDL regulation under Department of Transportation 49 CFR but are subject to the NWCG National Incident Operations Driving Standards.

These standards address driving by personnel actively engaged in wildland fire or all-risk response activities, including driving while assigned to a specific incident or during initial attack fire response (includes time required to control the fire and travel to a rest location). In the absence of more restrictive agency policy, these guidelines will be followed during mobilization and demobilization as well. Individual agency driving policies shall be consulted for all other non-incident driving.

- Agency resources assigned to an incident or engaged in initial attack fire

response will adhere to the current agency work/rest policy for determining length of duty day

- No driver will drive more than 10 hours (behind the wheel) within any duty day
- Multiple drivers in a single vehicle may drive up to the duty-day limitation provided no driver exceeds the individual driving (behind the wheel) time limitation of 10 hours
- Drivers shall drive only if they have had at least 8 hours off duty before beginning a shift
- **Exception to the minimum off-duty hour requirement is allowed when essential to:**
  - Accomplish immediate and critical suppression objectives
  - Address immediate and critical firefighter or public safety issues
  - Documentation of mitigation measures used to reduce fatigue is required for drivers who exceed 16-hour work shifts
  - This is required regardless of whether the driver was still compliant with the 10- hour individual (behind the wheel) driving limitations

### **Night Operations**

Every effort shall be made to orient work crews scheduled for night operations during daylight hours and provide adequate lights and communication. A knowledgeable day operations representative should remain on site to properly orient and brief night operations crews, particularly about line location and boundaries, terrain features, hazards, and control problem areas.

### **Safety Flagging Standards**

- Yellow-black striped ribbon denotes hazards
- Remove the yellow-black striped ribbon when the hazard is abated. If feasible, write on the ribbon the nature of the hazard; i.e., "snags - 200 feet up slope"
- Hot pink color marked ESCAPE ROUTE in black lettering denotes safety zones and escape routes

### **Hazard Trees**

- Trees have been burning for an extended period
- High-risk tree species (rotten and shallow root system)
- Numerous down trees
- Dead or broken tips and limbs overhead
- Accumulation of down limbs
- Absence of needles, bark, or limbs
- Leaning or hung-up trees
- Presence of snags in the fire area

### **Hazard Tree Safety**

- Environmental conditions that increase snag hazards:
  - Strong winds
  - Night operations
  - Steep slopes
  - Diseased or bug-kill areas

## **Safety Zone**

- Follow the Standard Firefighting Orders
- Always stay oriented to a safety zone (and alternate as needed)
- If you need to drive to the safety zone, ensure that:
  - Someone is watching the escape route
  - You have a “trigger point” that will cause a retreat with adequate time for travel
  - You have absolute communication ability with your lookout(s)
  - You have the ability to control civilian traffic that could obstruct your escape route

## **Develop a Travel LCES to assignment and between assignments:**

- Predict fire spread.
- Leader or lead engine scout route and potential safety zones.
- Lookout to observe all blind areas.
- Communication.
- Predict fire behavior.
- Determine need for protective action.
- Implement or coordinate with lead engine.
- Decide on safety zone option.
- Identify any hazards.
- Brief crew on safety zone plan, tactical plan, escape plan (to safety zone and for refuge).
- Crew stays close to structure.

## **Power Line Hazards**

If possible, the power company should deactivate lines in the fire area that may endanger firefighters. All personnel should be cautioned against directing water streams or aerial retardant into high-tension lines. They should also be made aware that the smoke may become charged and conduct the electrical current. Deactivated transmission and distribution lines may continue to pose a hazard due to conduction.

- Identify, map, and discuss at briefings all electrical lines on the incident
- If a power line falls on your vehicle, DON'T leave vehicle until the power company arrives. If the vehicle is on fire or fire is near, jump clear, DON'T hang on, and keep both feet together and bunny hop away
- Minimize operation of heavy equipment under power lines
- DON'T drive under power lines with long antennas
- DON'T fuel vehicles under power lines
- DON'T stand near power lines during air tanker or helicopter drops
- DON'T go near or move downed power lines
- DON'T direct fire retardant or water on power lines
- DON'T stand or work in dense smoke near power lines



### **Aerial Retardant/Bucket Operations**

Personnel can be injured by the impact of retardant/water dropped by aircraft. Direct personnel to clear out of target area when drop is to be made. If an individual is unable to retreat to a safe place, the safest procedure to minimize injury from the drop is to:

- Hold on to your hand tool away from your body
- Lie face down, with head toward oncoming aircraft and hard hat in place.
- Grasp something firm to prevent being carried or rolled about by the dropped liquid
- Do not run unless escape is assured
- Get clear of dead snags, tops, and limbs in drop area
- Working in an area covered by wet retardant or Class A foam should be done with caution due to slippery surfaces
- Wash retardant or Class A foam off skin, to prevent possible skin irritation

### **How to Properly Refuse Risk**

Every individual has the right and obligation to report safety problems and contribute ideas regarding their safety. Supervisors are expected to give these concerns and ideas serious consideration. When an individual feels an assignment is unsafe they also have the obligation to identify, to the degree possible, safe alternatives for completing that assignment. Turning down an assignment is one possible outcome of managing risk.

A “turn down” is a situation where an individual has determined they cannot undertake an assignment as given **and** they are unable to negotiate an alternative solution. The turn down of an assignment must be based on an assessment of risks and the ability of the individual or organization to control those risks. Individuals may turn down an assignment as unsafe when:

- There is a violation of safe work practices
- Environmental conditions make the work unsafe
- They lack the necessary qualifications or experience
- Defective equipment is being used
- Individual will directly inform their supervisor that they are turning down the assignment as given. The most appropriate means to document the turn down is using the criteria (Standard Firefighting Orders, 18 Watch Out Situations, etc.), outlined in the Risk Management Process
- Supervisor will notify the Safety Officer

**Immediately** upon being informed of the turn down. If there is no Safety Officer, notification shall go to the appropriate Section Chief or to the Incident Commander. This provides accountability for decisions and initiates communication of safety concerns within the incident organization.

- If the supervisor asks another resource to perform the assignment, they are responsible to inform the new resource that the assignment has been turned down and the reasons that it was turned down
- If an unresolved safety hazard exists or an unsafe act was committed, the individual should also document the turn down by submitting a SAFENET (ground hazard) or SAFECOM (aviation hazard) form in a timely manner

These actions do not stop an operation from being carried out. This protocol is integral to the effective management of risk, as it provides timely identification of hazards to the chain of command, raises risk awareness for both leaders and subordinates, and promotes accountability.

#### **4. RAPIDLY EVALUATE THE SITUATION (SIZE-UP)**

##### **Use Maps to:**

- Locate fire
- identify access route(s)
- locate values threatened
- Establish jurisdiction

##### **Fire Behavior:**

- Pay particular attention to all fire behavior information, especially predicted fire weather
- Monitor the seven critical factors

##### **Consider what you know about the area:**

- Type of fuel(s) and terrain
- Access problem(s) - "Will there be people leaving the area?"
- Control points (natural and man-made)
- Jurisdiction(s) - "May need to establish unified command"
- Local fire history
- Resources en route - "What resources are other jurisdiction(s) sending?"
- Additional resource availability - "Will there be difficulty in getting additional resources (ground or air)?"

**Fire behavior considerations:**

- Combination of fuels, topography, and weather effecting rate of spread?
- How will this fire burn when compared to others in similar areas?
- Is the fire danger increasing or decreasing?
- What time of day in relation to slope aspect?
- Changes in wind speed and direction from initial reports
- Presence of whirlwinds, dust devils as indicators of erratic winds
- Changes in cloud cover and build-up
- Unfavorable weather changes predicted
- Diurnal winds effecting fire behavior
- Observed weather conditions are much different from predicted conditions, especially wind speed and direction
- Request or obtain a spot weather forecast

**STRUCTURE TRIAGE GUIDELINES**

Firefighter safety is the primary consideration when evaluating whether a structure can be protected. There are three categories of structures:

- Those that are not threatened
- Those that are threatened and have the potential of being saved
- Those that can't be saved and are too dangerous to protect

**Wildland-Urban Watch-Outs**

- Poor access and narrow one-way roads
- Bridge load limits
- Wooden construction and wood shake roofs
- Power lines, propane tanks, and HazMat threats
- Inadequate water supply
- Natural fuels 30 feet or closer to structures
- Structures in chimneys, box canyons, narrow canyons, or on steep slopes (30% or greater)
- Extreme fire behavior
- Strong winds
- Evacuation of public (panic)

**Factors to consider during structure triage:**

- **FIREFIGHTER SAFETY**
- Safety Zone Availability (is there time to prepare a safety zone?)
- Proximity of the fuels and predicted flame length to structure (no defensible space)
- Position on slope relative to fire spread
- Fire behavior and intensity (the greater the intensity, the wider the defensible space needed)

- Flammability of roof and siding (wood roof and siding, vinyl siding, along with inadequate defensible space may make structure impossible to protect)
- Timing and available resources (not having time to position resources or lack of resources to protect structure)

**An attempt to save a structure may be unsuccessful or too dangerous if:**

- There is no safety zone and refuge available
- There is no place to park engine safely
- Fire is making a sustained run and there is little or no clearance
- Fire behavior is extreme: spot fires are numerous and out pacing control
- Water supply will not outlast the threat
- Fire's intensity dictates you leave the area NOW
- Roof is more than ¼ involved with fire
- Fire has involved the interior of structure, windows are broken, and conditions are windy
- Crew cannot safely remain at the structure and/or the escape route could become unsafe to use
- If a structure becomes well involved, leave it and move on to one that can be saved

**STRUCTURE ASSESSMENT CHECKLIST**

**Take Note of:**

- **Address/Property Name**
  - Numerical Street address, ranch name, etc.
  - Number of residents on site
- **Estimated Resources for Protection**
  - Number(s) and type(s) of engines, water tenders, crews, dozers (General Guidelines: one engine per structure, one additional engine for every four structures to be used as "backup" and for patrol)
  - For structures that are close together (50' or less), one engine may be adequate to protect two structures
  - Type and number of aircraft available
- **Road Access**
  - Road surface (paved, gravel, unimproved, dirt)
  - Adequate width, vegetation clearance and safety zones along road
  - Undercarriage problems (4x4 access only)
  - Turnouts and turnarounds
  - Bridges (load limits)
  - Stream crossings (approach angle, crossing depth and surface)
  - Terrain (road slope, location on slope-near chimneys, saddles, canyon bottom)
  - Grade (greater than 15%)

- **Structure/Building**
  - Single or multi family residence, commercial complex, out building (barn, storage, etc.)
  - Does building have unknown or hazardous materials?
  - Exterior walls (stucco or other noncombustible, wood frame, vinyl, wood shake)
  - Large unprotected windows facing heat source
  - Proximity of any aboveground fuel tanks (LPG, propane, etc.)
  - Roof material (wood shake, asphalt, noncombustible)
  - Eaves (covered with little overhang, exposed with large overhang)
  - Other features (wood deck, wood patio cover and furniture, wood fencing)
- **Clearances/Exposures/Defensible Space**
  - Structure location (narrow ridge, canyon, mid-slope, or chimney)
  - Adequate clearance around structure-minimum of 100' (steeper the slope the more clearance required)
  - Surrounding fuels (larger, denser the fuels, the more clearance required)
  - Flammable fuels (trees, ladder fuel, shrubs) adjacent to structure (is there time for removing these fuels?)
  - Other combustibles near structure (wood piles, furniture, fuel tanks)
  - Is there adequate clearance around fuel tank?
  - Power lines or transformers (DO NOT park under lines)
- **Hazardous Materials**
  - Chemicals (Look for DOT/NFPA/UN symbols)
  - Pesticides and herbicides
  - Petroleum products
  - Paint products
- **Water Sources**
  - Hydrant/standpipe (When connecting to hydrant, be aware of flow rate and gpm output, size and venting capability of engine or water tender may not be able to cope with hydrants that have high flow and gpm rates.)
  - Storage tank
  - Swimming pool
  - Hot tub
  - Fish pond
  - Irrigation ditch
- **Evacuation**
  - Is safe evacuation possible? (Identify safe refuge for those who cannot be evacuated)
  - Coordinate with on-scene law enforcement
- **Smoke column indicators:**
  - The smoke column can give some indication of fire conditions

## **5. DEVELOP A STRATEGY AND TACTICAL PLAN OF ATTACK**

There is a fundamental distinction between the strategy and the tactical plan. The strategy describes the general overall approach to controlling the incident and in turn drives the tactical plan. The tactical plan provides the tactical assignments required to achieve the strategic objectives.

### **When approaching the scene:**

- Use caution when approaching scene
- Observe fire scene for "Look Up, Look Down, Look Around" concerns
- Watch for people leaving the area, take information (license numbers, vehicle and suspicious person descriptions) that may assist with a fire investigation
- Identify best access routes into fire and escape routes; pass information on to incoming resources
- Initiate Risk Management Process
- **DO NOT CROSS THE FIRE'S HEAD UNLESS IT CAN BE DONE SAFELY!**
- Ensure that access into the fire scene is kept open and fire equipment is positioned to protect from fire damage and allow quick access out of the area
- Attempt to locate fire origin and protect area (**DO NOT** remove any evidence unless necessary to prevent destruction)
- Account for all personnel and equipment that are already on-scene
- Review Initial Attack Safety Checklist

### **TAKING ON-SCENE ACTION:**

**FIRES SHOULD BE FOUGHT AGGRESSIVELY, BUT SAFETY AND PROTECTION OF PERSONNEL AND EQUIPMENT MUST BE TOP PRIORITIES.**

### **REMEMBER:**

- **STANDARD FIREFIGHTING ORDERS**
- **LCES**
- **WATCH OUT SITUATIONS**
- **4 COMMON DENOMINATORS**
- Using the information from the fire size-up, develop incident strategy and fire suppression tactics, and ensure that assigned personnel know what they are and whom they report to
- Incident objectives to consider are as follows:
  - **FIREFIGHTER SAFETY**
  - Life hazard - "Protect residents leaving area"
  - Property values - "Keep fire from reaching housing tract"
  - Resource values - "Keep fire from reaching stand of timber"
- Keeping fire from spreading into heavier or more dangerous fuels
- Keeping fire isolated on one side or in a single canyon or drainage
- Making sure that all assigned resources contribute to suppression efforts



**The fire suppression strategy used to control a fire will depend on whether it is an offensive or defensive fire based in part on the following:**

- Is perimeter control possible given the:
  - Rate of spread, fire is moving too fast
  - Fire intensity (flame length)
  - Spotting potential
  - Values to be protected
  - More fire than resources given the kind and number of resources assigned

Present and predicted fire behavior and weather conditions will determine which strategy(s) and tactics the IC will employ. Flames generate the radiated heat of a fire and flame length will determine how close equipment and personnel work near or at the fire's edge. (Refer to table below).

**FIRE SUPPRESSION INTERPRETATIONS FROM FLAMELENGTH**

Flame Length	Interpretations
<b>Less than 4 feet</b>	Fires can generally be attacked at the head or flanks by firefighters using hand tools. Handlines should hold fire.
<b>4 to 8 feet</b>	Fires are too intense for direct attack on the head with hand tools. Handlines cannot be relied on to hold the fire. Bulldozers, engines, and retardant drops can be effective.
<b>8 to 11 feet</b>	Fire may present serious control problems: torching, crowning, and spotting. Control efforts at the head will probably be ineffective.
<b>Over 11 feet</b>	Crowning, spotting, and major fire runs are probable. Control efforts at the head of the fire are ineffective.

Whether the suppression tactics are either a direct or indirect attack, they need to start from an anchor point (road, creek, burned out area, etc.).

Employ a standardized method of assigning resources. When viewed from behind the point of origin looking towards the direction of spread the left flank shall be designated Division A (alpha) and the right flank shall be designated Division Z (zebra). If structures are threatened then a Structure Protection Group should be formed, and if the size of the fire warrants it, a Structure Protection Branch would be appropriate.

Where structures are threatened and the structures are closely spaced as in a typical urban canyon interface, the standard of protection should be one engine company for every two or three

structures. If there are not enough resources to provide this level of coverage then structure protection units will be forced to Triage and prioritize the structures in terms of whether they are:

- Savable
- Defensible
- Un-savable

As an example: Assume there are 100 homes in a development that is threatened and only 10 engine companies are available for protection. Given this scenario, the Branch Director or Group Supervisor as a suggestion might:

- Scout the area if time permits
- Establish geographic boundaries
- Assign resources in pairs
- Assign extra personnel to companies
- Form up extra personnel in alternative transportation or on foot with hose and nozzles to operate off hydrants

### **Engine Operations**

- All vehicles going to fires should stop for traffic lights and stop signs, even when using emergency warning lights, siren, and air horns. Watch for oncoming traffic
- Mark vehicles parked on highway at fires by flags or warning lights in front and back to warn motorists of presence of equipment and personnel
- Park engines on the side of road away from oncoming fire to reduce heat exposure on equipment and to allow other vehicles to pass
- Do not park on mid slope roads, in saddles, or chimneys unless a compelling tactical decision necessitates it
- **DO NOT BLOCK THE ROAD WITH YOUR ENGINE**
- Engine will be positioned for a quick getaway
- Engines should be attended at all times
- Nozzle operators should wear eye protection
- When fires make hot runs upslope, it is safer to draw back to the flanks and let the fire cross the road than to attempt a frontal assault
- Adequate supervision and good communications, including hand signals, are necessary for safe, effective engine work

### **Equipment Placement**

- Identify escape routes and safety zones and make them known to all crew members
- Stay mobile; keep equipment running, emergency red lights on and wear all PPE
- Back equipment in for quick escape
- Mark entrance to long driveways to show that protection is in place (very important when structure cannot be seen from road)

- Multiple ribbons at end of drive on street
  - Ribbon/flagging across drive entrance
  - Sign
  - Other pre-determined signal
- Park in a cleared area (watch for overhead hazards)
- Protect your equipment (park behind structure, placing structure between equipment and fire front; be aware of spot fires occurring behind you)
- Watch for hazards (drop-offs, pot holes, above-ground fuel storage, chemicals, and septic tanks)
- Keep egress route clear:
  - Park extra equipment on street
  - Keep hose off driveway
- Coil a short 1½ inch charged line with fog nozzle on your engine for safety and quick knock-down
- DO NOT make long hose lays
- Try to keep sight contact with all crewmembers

### **Water Use Guidelines**

- Keep at least 100 gallons of water reserve in your tank
- Top off tank at every opportunity; use garden hose
- Draft from swimming pool, hot tub, and fishpond
- STAY MOBILE. Do not hook up to hydrant except to refill tank. (Hydrant may not always work if system is electric powered and power is lost in area)
- CONSERVE WATER, avoid wetting down an area
- Apply water only if it controls fire spread or significantly reduces heating of structure being protected
- Keep fire out of the heavier fuels
- Extinguish fire at its lowest intensity, not when it is flaring up
- Knock down fire in the lighter fuels
- Have enough water to last duration of main heat wave and to protect crew
- Direct water at base of flame
- Have hand tool personnel work with nozzle personnel to make most effective use of water, especially during mop-up
- Ensure good communications between nozzle personnel and water source
- Plan for ample water supply--request water tenders as needed
- Coordinate so all units do not run out of water at once during critical period
- Do not block roads
- Keep engines pointed in a direction for quick escape
- After direct attack with water, follow up with a fireline to mineral soil around the entire fire, resources permitting
- Provide eye protection to all personnel working with nozzle
- Use foam or other water additives to increase effectiveness and save water

## **Class “A” Foam Use Guidelines**

- Direct Attack - apply to base of flame
- Indirect Attack - lay out wet line and burn out
- Apply to structure (roof and siding) 10-15 minutes before fire arrives

## **Preparing Structure**

- Determine if residents are home (legal responsibility for evacuation lies with law enforcement). If residents remain on-scene, advise them to use structure if it's safe to do so as refuge when fire arrives
- For roof access, place owner's ladder at a corner of structure on side with least fire threat and away from power drop
- Clean roof of leaves, needles, and any other combustible materials
- Cover vents and air conditioning unit on roof
- Remove and scatter away from structure:
  - Over-hanging limbs
  - Ground/ladder fuels to prevent fire from moving into the crowns
  - Wooden fences and wood piles near structure
- Clear area around above-ground fuel tank, shutting off tank
- Place combustible outside furniture inside structure
- Close windows and doors, including garage, leaving unlocked. **AS A LAST RESORT, YOU MAY NEED TO USE STRUCTURE AS REFUGE**
  - In this instance, take shelter inside the structure until the flame front passes
- Have garden hose(s) charged and place strategically around structure for immediate use

## **Directing Retardant and Bucket Drops**

- Give general location on incident
- Finalize location with:
  - Clock direction - straight in front of the aircraft is 12 o'clock, out the right door is 3 o'clock, the tail is 6 o'clock, and the left door is 9 o'clock
  - When giving direction, remember that helicopters and air attack generally orbit in a right-hand pattern and air tankers in a left-hand pattern
  - Position on slope - lower third, upper third, mid slope, top of ridge, etc.
  - Aspect - direction slope is facing
  - Describe prominent landmarks - Don't say, "I have a red hard hat. I'm wearing a yellow shirt. I'm waving. I'm by a big rock. I'm by the big tree." Visualize what the pilot sees from the air and describe the target
- Use signal mirrors - use smoke or fusee, if a mirror is unavailable. Stand in drop location (when safe) for identification and move away before drop
- Describe target from your location and explain mission. The pilot will decide drop technique and flight path
- Assure pilot all personnel are safe and know aircraft intentions before the drop
- Give feedback to pilot about drop accuracy. Be honest and constructive. Let the pilot know if drop is early, late, uphill, downhill, on target too high, or too low. Report low drops immediately

### **Helicopter Use Guidelines**

- Helicopters may be the first unit to arrive at the fire. They are often used to drop water, foam, or fire retardant
  - The initial attack incident commander should integrate this resource into the tactical plan
- Helicopters may be used for reconnaissance work
- Helicopters may be used to transport equipment, supplies, or personnel if certified to do so

### **Burning Out Guidelines**

- Burn according to a plan, have a starting point and an end point
- Always have an anchor point to support burning operations
- Do not start burning out until a control line has been prepared and adequate firefighting forces are available to hold line
- Fall snags and remove ladder fuels before burning out
- When possible, fire from the top down in steep topography; fire into the wind; fire from the lee side or ridge top; fire from a wide canyon bottom; fire from roads or benches
- Manage the amount of heat generated; too much heat may cause fire to jump control lines; not enough heat will cause an unclean burn and require extensive mop-up
- Burning operations must not adversely affect the actions of other firefighting forces
- Keep those around you informed when burning out; firefighters not kept informed may see the burning operation and think it's a flare-up or slop-over

### **Incident Mop-up**

- Start mop-up as soon as line construction and burnout operations are completed
- In an urban area, all material inside the line needs to be extinguished and mopped up to prevent a rekindle, possible escape, and to prevent further responses to the same fire
- Mop-up can be done with water (wet mop-up) or without water (dry mop-up)
- Use hand tools as well as hose lines; it greatly speeds up the mop-up process

# INITIAL ATTACK SAFETY CHECKLIST

Answer the following questions (repeat this checklist whenever there is a change in conditions on the fire or a predicted change in fire conditions). If the answer is NO to any of the checklist questions, you MUST take the appropriate corrective action(s) **IMMEDIATELY**.

**Yes No**

- Does everyone (dispatch and on-scene resources) know who the Incident Commander is?
- Have you sized up the fire and established Incident Objectives?
- Have you initiated the Risk Management Process?
- Do you have a current fire weather forecast for fire location?
- Is the observed fire weather consistent with the forecast?
- Have you developed a plan to attack the fire (direct or indirect, anchor points, priority areas)? Have you communicated this plan to all personnel assigned to the fire, including new arrivals?
- Can you control the fire with the resources available (on-scene and en route) under expected conditions?
- Do you have sufficient supervision on-scene?
- Do you have a complete list of resources on-scene and have been ordered for the fire?
- Are Watch-out Situations and Standard Firefighting Orders being followed?
- Lookouts in place or you can see all of the fire area?
- Can you Communicate with everyone on the fire and with dispatch?
- Escape routes and Safety zones established? (If you are using the black, is it completely burned out and without a re-burn potential?)
- Will you control the fire before the next operational period?
- Have you reported the fire's status to dispatch?
- If the fire will not be controlled before the next operational period, have you informed agency headquarters?
- Does the fire size or complexities remain within your capabilities and qualifications to manage the fire?



## **After Action Review**

### **What was planned?**

- Review the primary objectives and expected action plan.

### **What actually happened?**

- Review the day's actions:
  - Identify and discuss effective and ineffective performance
  - Identify barriers that were encountered and how they were handled
  - Discuss all actions that were not standard operating procedure, or those that presented safety problems

### **Why did it happen?**

- Discuss the reasons for ineffective or unsafe performance. Concentrate on WHAT, not WHO

### **What can we do next time?**

- Determine lessons learned and how to apply them in the future

**\*\*Additional supporting information for this document can be found in Target Solutions. From the home page, click on the "Training" link in the right-hand column, then select the "Wildland Refresher" link.**