



Arrow XT™



TABLE OF CONTENTS



CHAPTER 1. FOREWORD

To the Owner and Operator

1-1	WHO SHOULD USE, SERVICE, AND MAINTAIN THIS VEHICLE	1-1
1-2	VEHICLE IDENTIFICATION	1-3
1-3	CUSTOMER ASSISTANCE INFORMATION	1-4
1-4	RESPONSIBILITY	1-4
1-5	PROFESSIONAL, TRAINING, AND STANDARDS ORGANIZATIONS	1-5

CHAPTER 2. SAFETY

Safety and Responsibility

2-1	WARNINGS AND CAUTIONS	2-1
2-1.1	WARNING AND CAUTION STATEMENTS	2-1
2-1.2	GENERAL WARNINGS AND CAUTIONS	2-2
2-1.3	SAFETY WARNING LABELS	2-2
2-2	BACKING THE VEHICLE	2-7
2-3	VEHICLE HANDLING CHARACTERISTICS	2-7
2-4	ELECTROCUTION HAZARD FROM OVERHEAD POWER LINES	2-8
2-5	HIGH PRESSURE HYDRAULIC FLUID	2-9
2-6	TANKER (MOBILE WATER SUPPLY) TRUCK CHARACTERISTICS	2-9
2-6.1	DESCRIPTION OF HAZARD	2-9
2-6.2	RECOMMENDATIONS FOR PREVENTION	2-10
2-7	LOCKOUT/TAGOUT	2-11
2-8	SAFETY DEFECT REPORTING	2-11

CHAPTER 3. BEFORE PLACING VEHICLE IN SERVICE

Axles, Tires, and Brakes

3-1	AXLE WEIGHTS AND AXLE CAPACITY	3-1
3-2	TIRE PRESSURE	3-2
3-3	BRAKE BALANCE	3-2
3-4	BRAKE BURNISHING	3-5
3-4.1	GENERAL INFORMATION	3-5
3-4.2	PROCEDURE	3-5

TABLE OF CONTENTS

Equipment, Accessories, and Adjustments

3-5	CARWELL REMOVAL	3-7
3-6	CUSTOMER-INSTALLED EQUIPMENT	3-7
3-6.1	MODIFICATION	3-7
3-6.2	DRILLING HOLES OR WELDING	3-8
3-6.3	DISSIMILAR METAL CORROSION	3-8
3-7	RADIO EQUIPMENT	3-8
3-7.1	CAB EXTERIOR EQUIPMENT	3-8
3-7.2	CAB INTERIOR EQUIPMENT	3-9
3-7.3	AIR PRESSURE OPERATED EQUIPMENT	3-10
3-8	EQUIPMENT AND CARGO LOADING	3-10
3-9	FRONT SPRING/SUSPENSION ADJUSTMENT	3-11
3-9.1	TAK-4™ INDEPENDENT FRONT SUSPENSION	3-11
3-9.2	LEAF SPRING SUSPENSION	3-11
3-10	REAR SPRING/SUSPENSION ADJUSTMENT	3-12
3-10.1	TAK-4™ INDEPENDENT REAR SUSPENSION	3-12
3-11	SUSPENSION	3-12
3-11.1	SPRING SUSPENSIONS (<i>SPRING U-BOLTS</i>)	3-12
3-11.2	AIR AND RUBBER SUSPENSIONS	3-12

CHAPTER 4. GENERAL

Safe Vehicle Entry and Exit

4-1	VEHICLE ACCESS	4-1
4-1.1	AUTOMATIC STEPS	4-1
4-1.2	SERVICE AREAS	4-1
4-1.3	HIGH LOCATIONS	4-1
4-1.4	NO-STEP SURFACES	4-2
4-1.5	DO NOT OCCUPY WITH VEHICLE IN MOTION	4-2
4-2	KEYLESS ENTRY (<i>OPTIONAL</i>)	4-2
4-2.1	TO UNLOCK OFFICER'S DOOR	4-2
4-2.2	TO UNLOCK ALL DOORS	4-2
4-2.3	LOCKING THE DOORS WITH KEYPAD	4-3
4-2.4	ADDITIONAL INFORMATION	4-3

Seats, Seat Belts, and Safety Restraints

4-3	SAFETY RESTRAINTS AND DEVICES	4-4
4-3.1	SEAT BELTS	4-4
4-3.2	SEAT BELT MONITORING SYSTEM	4-5
4-3.3	SIDE ROLL PROTECTION SYSTEM (<i>OPTIONAL</i>)	4-5
4-3.4	FRONTAL IMPACT PROTECTION (<i>OPTIONAL</i>)	4-10
4-3.5	SCBA BRACKETS MOUNTED IN SEAT BACKS	4-11
4-3.6	SEAT ADJUSTMENT	4-12

4-3.7 ADJUSTABLE FOOT PEDALS (*OPTIONAL*) 4-12

Controls, Indicators, and Features

4-4 HEATING, VENTILATION, AIR CONDITIONING (HVAC) 4-13

4-4.1 DEFROSTER 4-13

4-4.2 HEATER 4-13

4-4.3 AIR CONDITIONING 4-13

4-5 HOSE AND HOSE REELS 4-14

4-6 INSTRUMENT PANEL CONTROLS & INDICATORS 4-14

4-6.1 TYPICAL ARROW XT™ INSTRUMENT PANEL 4-15

4-6.2 TYPICAL ARROW XT™ RIGHT HAND STEER INSTRUMENT PANEL 4-19

4-6.3 STEERING WHEEL CONTROLS (*OPTIONAL*) 4-21

4-7 WINDSHIELD WIPER SYSTEM 4-21

4-8 VEHICLE DATA RECORDER (VDR) 4-22

4-9 COMMAND ZONE III 4-23

CHAPTER 5. OPERATION

Pre-Trip Inspections

5-1 PRE-TRIP INSPECTION 5-1

5-1.1 REASONS FOR DAILY INSPECTION 5-1

5-1.2 BEGINNING THE INSPECTION 5-1

5-1.3 THINGS TO LOOK FOR DURING INSPECTIONS 5-2

5-1.4 INTERIOR INSPECTION 5-4

5-1.5 EXTERIOR INSPECTION 5-5

5-1.6 BRAKE TESTING 5-8

General Operation

5-2 CAB OCCUPANT CAPACITY 5-10

5-3 COMPARTMENT DOORS 5-10

5-4 CAB TILT OPERATION 5-11

5-4.1 CAB LIFT SYSTEM 5-12

5-4.2 MANUAL PUMP OPERATION (*OPTIONAL*) 5-12

5-5 ELECTRICAL 5-13

5-5.1 ALTERNATOR 5-13

5-5.2 AMMETER (*OPTIONAL*) 5-13

5-5.3 BATTERY 5-14

5-5.4 BATTERY CHARGING PRECAUTIONS 5-14

5-5.5 BATTERY SWITCH 5-15

5-5.6 VOLTMETER 5-15

5-5.7 CIRCUIT BREAKERS AND FUSES 5-15

5-5.8 HOURMETER 5-15

5-5.9 PYROMETER (*OPTIONAL*) 5-15

5-5.10 SPEEDOMETER AND ODOMETER 5-15

TABLE OF CONTENTS

5-5.11	LOW FUEL WARNING LIGHT	5-15
5-5.12	TACHOMETER	5-16
5-5.13	TURN SIGNAL SWITCH	5-16
5-5.14	WARNING LIGHTS	5-16
5-5.15	HAZARD FLASHERS	5-16
5-5.16	STARTER AND IGNITION SWITCHES	5-17
5-5.17	RADIO INSTALLATION	5-17
5-6	FIRE SCENE OPERATION	5-17
5-6.1	HIGH HEAT SOURCES	5-17
5-6.2	FLYING EMBERS	5-17
5-7	MIRRORS	5-18
5-8	PUMP	5-18
5-9	WATER FORDING CAPABILITY	5-19
5-9.1	GENERAL FORDING INSTRUCTIONS	5-19
5-9.2	FORDING WATER WITH COMMAND ZONE™ VEHICLES	5-20
5-10	WINCH OPERATION	5-21
Engine Exhaust After Treatment Systems		
5-11	INTRODUCTION	5-22
5-11.1	EMISSIONS EQUIPMENT AND FUNCTIONS	5-22
5-12	CUMMINS REGENERATION	5-23
5-12.1	AFTER TREATMENT DEVICE INDICATOR LIGHTS - CUMMINS ENGINES	5-23
	CUMMINS ENGINE INSTRUMENT ATD PANEL LIGHTS (TABLE 5-1)	5-23
5-12.2	PASSIVE REGENERATION	5-24
5-12.3	ACTIVE REGENERATION	5-24
5-12.4	PARKED REGENERATION	5-25
	CUMMINS PARKED REGENERATION ENGINE SPEEDS (TABLE 5-2)	5-25
	PERFORMING A PARKED REGENERATION (CUMMINS) (TABLE 5-3)	5-26
5-12.5	REGENERATION INHIBIT	5-27
5-12.6	MAINTENANCE	5-27
5-13	DETROIT DIESEL ATD REGENERATION	5-28
5-13.1	AFTER TREATMENT DEVICE INDICATOR LIGHTS - DETROIT DIESEL	5-28
	DETROIT DIESEL ATD INSTRUMENT PANEL LIGHTS (TABLE 5-4)	5-28
5-13.2	PASSIVE REGENERATION	5-29
5-13.3	ACTIVE REGENERATION	5-29
5-13.4	PARKED REGENERATION	5-30
	PERFORMING A PARKED REGENERATION (DETROIT) (TABLE 5-5)	5-31
5-13.5	REGENERATION INHIBIT	5-32
5-13.6	MAINTENANCE	5-32
5-14	SELECTIVE CATALYTIC REDUCTION (SCR) AND DEF OPERATION	5-33
	CUMMINS AND DETROIT DEF FLUID INDICATOR LAMPS AND WARNINGS (TABLE 5-6)	5-33

Operating the Engine

5-15 STARTING THE ENGINE 5-34

5-16 RUNNING THE ENGINE 5-35

 5-16.1 EXCESSIVE IDLING 5-35

 5-16.2 ENGINE-SPECIFIC OPERATION INSTRUCTIONS 5-35

5-17 STOPPING THE ENGINE 5-36

5-18 EMERGENCY SHUTDOWN (OPTIONAL) 5-36

5-19 COOLING SYSTEM 5-37

 5-19.1 FAN CLUTCH 5-38

5-20 STARTING ENGINE USING POWER FROM ANOTHER VEHICLE 5-38

5-21 OPERATION OF ENGINE IN FUEL RICH ATMOSPHERE 5-39

5-22 AIR RESTRICTION INDICATOR 5-39

5-23 FLUID REQUIREMENTS 5-40

 5-23.1 DIESEL FUEL REQUIREMENTS 5-40

 5-23.2 ENGINE OIL REQUIREMENTS 5-40

 5-23.3 DIESEL EXHAUST FLUID (DEF) - 2010 EPA ENGINES AND BEYOND 5-40

5-24 HAND THROTTLE 5-42

5-25 COLD WEATHER OPERATION 5-42

 5-25.1 COLD WEATHER PUMPER OPERATION 5-42

Driving the Vehicle

5-26 TRANSMISSION 5-44

 5-26.1 AUTOMATIC TRANSMISSION 5-44

 5-26.2 TRANSMISSION OPERATING TEMPERATURE 5-44

 5-26.3 NEUTRAL TO DRIVE SHIFT GROWL - ALLISON MD TRANSMISSION 5-44

 5-26.4 4X4 TRANSFER CASE (ALL WHEEL DRIVE) 5-45

 5-26.5 4X4 (ALL WHEEL DRIVE) AND TWO-SPEED AXLE COMBINATION 5-45

 5-26.6 POWER TAKE-OFF CONTROL 5-45

5-27 AXLES 5-46

 5-27.1 NO SPIN DIFFERENTIAL (OPTIONAL) 5-46

 5-27.2 MERITOR DRIVER CONTROLLED DIFFERENTIAL LOCK (DCDL) (OPTIONAL) 5-47

 5-27.3 DANA DRIVE AXLE WHEEL DIFFERENTIAL LOCK (OPTIONAL) 5-47

 5-27.4 INTER AXLE DIFFERENTIAL (IAD) LOCK (TANDEM AXLES) 5-47

 5-27.5 OSHKOSH® TAK-4® REAR AXLES 5-48

 5-27.6 TWO-SPEED REAR AXLE 5-49

5-28 BRAKES 5-50

 5-28.1 DOWNHILL OPERATION OR HEAVY BRAKING 5-50

 5-28.2 AIR PRESSURE GAUGE, INDICATOR LIGHT, AND AUDIBLE ALARM 5-50

 5-28.3 ANTILOCK BRAKING SYSTEM (ABS) 5-50

 5-28.4 TRACTION CONTROL (OPTIONAL) 5-51

 ATC LIGHT OPERATION - 4X4 CHASSIS WITH ESC (TABLE 5-7) 5-51

 5-28.5 PARKING BRAKES 5-51

 5-28.6 MANUAL PARKING BRAKE RELEASE (CAGING BRAKES) 5-52

TABLE OF CONTENTS

5-28.7	EMERGENCY PARKING BRAKE RELEASE (<i>OPTIONAL</i>)	5-52
5-28.8	AUXILIARY FRONT WHEEL LOCK (<i>OPTIONAL</i>)	5-53
5-28.9	AIR RESERVOIR MOISTURE DRAINING	5-53
5-28.10	AIR DRYER	5-53
5-28.11	GRADE HOLDING AND BRAKE BURNISHING	5-53
5-29	AUXILIARY BRAKING SYSTEM	5-54
5-29.1	COMPRESSION BRAKE	5-54
5-29.2	EXHAUST BRAKE	5-54
5-29.3	ELECTROMAGNETIC RETARDER	5-54
5-29.4	HYDRAULIC RETARDER	5-55
5-30	STABILITY CONTROL (<i>OPTIONAL</i>)	5-56
5-30.1	SAFE VEHICLE OPERATION	5-56
5-30.2	ROLL STABILITY CONTROL (RSC)	5-56
5-30.3	ELECTRONIC STABILITY CONTROL (ESC)	5-57
5-31	STEERING	5-58
5-31.1	STEERING COLUMN ADJUSTMENT	5-58
5-32	TIRE CHAINS	5-58
5-32.1	CHAIN CLEARANCE	5-58
5-32.2	AUTOMATIC TIRE CHAINS	5-59
5-33	TIRE PRESSURE MANAGEMENT SYSTEM	5-60
5-33.1	TIRE PRESSURE MANAGEMENT (<i>STANDARD</i>)	5-60
5-33.2	TIRE PRESSURE MANAGEMENT (<i>OPTIONAL</i>)	5-60

CHAPTER 6. MAINTENANCE

Cab

6-1	CAB TILT SYSTEM	6-1
6-1.1	COLD WEATHER OPERATION	6-1
	CAB LIFT CYLINDER FLUID CHART (TABLE 6-1)	6-1
6-2	DOORS AND WINDOWS	6-1
6-2.1	LATCHES AND WINDOW REGULATORS	6-1
6-2.2	DOOR STRIKERS	6-1
6-2.3	HINGES	6-2
6-2.4	WEATHERSTRIP	6-2
6-3	WIPER BLADES	6-2
6-4	HEATING, VENTILATION, AIR CONDITIONING (HVAC)	6-2
6-4.1	HEATER SHUT-OFF (<i>OPTIONAL</i>)	6-2
6-4.2	AIR CONDITIONING (<i>OPTIONAL</i>)	6-3
6-5	SAFETY RESTRAINTS AND DEVICES	6-5
6-5.1	SEAT BELTS	6-5
6-5.2	SIDE ROLL PROTECTION SYSTEM (<i>OPTIONAL</i>)	6-6

Chassis

6-6 AERIAL DEVICE BOOM SUPPORT 6-7

6-7 AUTOMATIC LUBRICATION SYSTEMS 6-7

6-7.1 RESERVOIR 6-7

6-7.2 INSPECTION 6-7

6-7.3 CONDITION OF LUBE POINTS 6-7

6-8 FASTENERS 6-7

6-8.1 INTERIOR FASTENERS 6-7

6-8.2 FRAME FASTENERS 6-8

GRADE 8 COURSE THREAD FASTENER TORQUE CHART (TABLE 6-2) 6-8

GRADE 8 FINE THREAD FASTENER TORQUE CHART (TABLE 6-3) 6-8

6-8.3 BUMPER EXTENSION CARRIAGE BOLTS 6-8

6-8.4 OTHER FASTENERS 6-8

6-9 FIFTH WHEEL LUBRICATION (TILLER ONLY) 6-9

6-9.1 GREASE FITTING LOCATION 6-9

6-9.2 LUBRICATION PROCEDURE 6-9

Axles, Brakes and Suspension

6-10 AXLES 6-11

6-10.1 FRONT AXLE – NON-DRIVING 6-11

6-10.2 FRONT AXLE ALIGNMENT 6-11

6-10.3 FRONT AXLE – TAK-4™ SUSPENSION 6-11

6-10.4 REAR AXLE 6-11

6-10.5 REAR AXLE ALIGNMENT 6-12

6-10.6 REAR AXLE – TAK-4™ SUSPENSION 6-12

6-11 BRAKES 6-12

6-11.1 BRAKES – GENERAL 6-12

6-11.2 BRAKES – TAK-4™ SUSPENSION 6-13

6-11.3 AIR DRYER 6-13

6-12 REAR SUSPENSION 6-13

6-13 SPRING SUSPENSION (FRONT AND REAR) 6-13

6-13.1 SPRINGS 6-13

U-BOLT FASTENER TORQUE CHART (TABLE 6-4) 6-14

6-13.2 SUSPENSION SHACKLES 6-14

CLAMP BOLT TORQUE CHART (TABLE 6-5) 6-14

6-13.3 SPRING PINS 6-14

6-14 TAK-4™ SUSPENSION 6-15

6-14.1 FRONT TAK-4™ SUSPENSION 6-15

6-14.2 REAR TAK-4™ SUSPENSION 6-15

Electrical

6-15 COMMAND ZONE™ SYSTEM 6-16

6-15.1 OVERVIEW 6-16

6-15.2 MULTIPLEX SYSTEM PRINCIPALS OF OPERATION 6-17

TABLE OF CONTENTS

6-15.3	TROUBLESHOOTING TIPS	6-17
6-16	ELECTRICAL, DC	6-19
6-16.1	ALTERNATOR	6-19
6-16.2	BATTERIES	6-19
6-16.3	WIRE HARNESSSES AND ELECTRICAL CONNECTORS	6-19
6-17	ELECTRICAL, AC	6-19
6-17.1	ALTERNATING CURRENT (AC) SYSTEM (120V-240V) INTRODUCTION	6-19
6-17.2	AUXILIARY POWER UNITS (APUs)	6-20
6-17.3	SHORE POWER	6-20
6-17.4	INVERTERS	6-20
6-17.5	BEFORE SERVICING HIGH VOLTAGE EQUIPMENT	6-21

Engine, Cooling, Fuel and Exhaust

6-18	ENGINE	6-22
6-18.1	AIR INTAKE SYSTEM	6-22
6-18.2	AIR INTAKE AND CHARGE AIR COOLER HOSE CLAMPS	6-22
6-18.3	FAN AND ACCESSORY BELTS	6-22
6-18.4	ENGINE SERVICE SCHEDULE	6-23
6-18.5	ENGINE MOUNT ISOLATORS	6-23
6-18.6	ENGINE DIAGNOSTIC SOFTWARE - <i>DETROIT</i>	6-23
6-18.7	ENGINE DIAGNOSTIC SOFTWARE - <i>CUMMINS</i>	6-23
6-19	COOLING SYSTEM	6-23
6-19.1	GENERAL INSPECTION AND SERVICE	6-24
6-19.2	HOSES	6-24
6-19.3	HOSE CLAMPS	6-24
6-19.4	WATER PUMP	6-24
6-19.5	THERMOSTATS	6-24
6-19.6	COOLANT	6-25
6-19.7	ANTIFREEZE TYPE	6-25
6-19.8	COOLANT FILL PROCEDURE	6-26
6-20	FUEL SYSTEM	6-27
6-20.1	FUEL DELIVERY SYSTEM	6-27
6-20.2	FUEL FILTERS	6-27
6-21	EXHAUST SYSTEM	6-27
6-21.1	GENERAL NOTES FOR ALL 2010 EPA & 2013 EPA ENGINES	6-28
6-21.2	EXHAUST DIFFUSERS	6-28

Driveline

6-22	DRIVESHAFTS	6-29
6-23	TRANSMISSION	6-29
6-23.1	TRANSMISSION FLUID	6-29
6-23.2	TRANSMISSION FLUID ANALYSIS	6-29
6-23.3	EXTERNAL TRANSMISSION COOLERS	6-30

6-24 TRANSFER CASE (ALL WHEEL DRIVE) 6-30

Steering

6-25 STEERING 6-31

6-25.1 GENERAL INSPECTION 6-31

6-25.2 TAK-4™ STEERING 6-31

6-25.3 STEERING RESERVOIR 6-31

6-25.4 STEERING SYSTEM FASTENER TORQUE 6-32

STEERING SYSTEM FASTENER TORQUE CHART - EXCEPT TAK-4™ (TABLE 6-6) 6-32

STEERING SYSTEM FASTENER TORQUE CHART - TAK-4™* (TABLE 6-7) 6-32

6-25.5 ALL STEER® ALL-WHEEL STEERING (OPTIONAL) 6-32

Towing

6-26 TOWING INSTRUCTIONS 6-33

6-26.1 PREPARATION FOR TOWING 6-33

6-26.2 FRONT TOWING 6-33

6-26.3 REAR TOWING 6-34

6-26.4 TOW HOOKS AND TOW EYES 6-34

6-26.5 TAK-4™ FRONT SUSPENSION TOWING 6-35

6-26.6 TAK-4® T3 REAR STEERING AXLE TOWING 6-35

6-26.7 TIRE LIFT METHOD (PREFERRED) 6-37

6-26.8 LIFT AND TOW USING FRAME FORKS 6-38

Welding

6-27 WELDING INSTRUCTIONS 6-40

6-27.1 WELDING ON FRAMES 6-40

6-27.2 BEFORE WELDING 6-40

ELECTRONIC COMPONENTS DISCONNECT TABLE (BEFORE WELDING) (TABLE 6-8) 6-41

6-27.3 BATTERY SYSTEM PROTECTION 6-42

6-27.4 AFTER WELDING 6-42

Wheels and Tires

6-28 TIRES 6-43

6-28.1 FIRE SERVICE RATED TIRES 6-43

6-28.2 FIRE SERVICE RATINGS 6-43

6-28.3 FIRE SERVICE RATING RULES 6-43

6-28.4 TIRE INFLATION 6-44

TIRE DATA CHART (TABLE 6-9) 6-45

6-28.5 MATCHING 6-46

6-28.6 TIRE WEAR INSPECTION 6-46

6-28.7 TIRE ROTATION 6-47

6-28.8 BALANCING 6-47

6-28.9 TIRE PRESSURE MANAGEMENT SENSORS 6-47

6-28.10 EMISSIONS RELATED TIRE WARRANTY 6-47

6-28.11 TIRE REPLACEMENT INFORMATION 6-48

6-29 WHEELS 6-48

6-29.1 BEARINGS 6-48

6-29.2 WHEEL INSTALLATION – GENERAL 6-48

TABLE OF CONTENTS

6-29.3	HUB PILOTED WHEEL INSTALLATION	6-49
	WHEEL NUT TORQUE CHART (TABLE 6-10)	6-49
6-29.4	STUD PILOTED WHEEL INSTALLATION (OPTIONAL)	6-49
	WHEEL NUT TORQUE CHART (TABLE 6-11)	6-50
6-29.5	CAST SPOKE WHEELS (OPTIONAL)	6-51
6-29.6	ALUMINUM REAR DISC WHEELS WITH FLANGE NUTS (HUB PILOTED)	6-52
6-29.7	RIM AND WHEEL INSPECTION	6-52

CHAPTER 7. LUBRICATION AND MAINTENANCE INTERVALS

Scheduled Inspections

7-1	INTRODUCTION	7-1
7-1.1	INITIAL INSPECTION UPON DELIVERY	7-1
7-1.2	DAILY INSPECTIONS	7-2
7-1.3	WEEKLY INSPECTIONS	7-3
7-1.4	MONTHLY INSPECTIONS	7-4
7-1.5	SEMI-ANNUAL INSPECTIONS	7-5
7-1.6	ANNUAL INSPECTIONS	7-6
7-1.7	3-5 YEAR INSPECTIONS	7-6
7-1.8	VENDOR COMPONENT INSPECTIONS	7-7

APPENDIX A. MOBILE RADIO INSTALLATION GUIDE A-1

APPENDIX B. EXTERIOR CARE OF YOUR VEHICLE B-1

b-1	EXTERIOR CARE OF YOUR VEHICLE	b-1
b-1.1	FINISHED SURFACES OF THE VEHICLE	b-1
b-2	WASHING THE VEHICLE	b-2
b-2.1	PROPER WASHING EQUIPMENT AND METHODS	b-2
b-2.2	GENERAL WASHING INSTRUCTIONS	b-3
b-2.3	TAR, RUST OR OTHER CONTAINMENT REMOVAL	b-3
b-2.4	CHROME CLEANING	b-4
b-2.5	ABS PLASTIC AND CLEAR LEXAN COMPONENT CARE	b-4
b-2.6	UNDERCARRIAGE CLEANING AND PROTECTION	b-4
b-3	PROTECTING THE FINISHED SURFACE	b-5
b-3.1	WAXING THE VEHICLE	b-5
b-3.2	PREVENTING DISSIMILAR METAL CORROSION	b-5
b-4	FINISH TOUCH-UP AND REPAIR	b-6
b-4.1	GOLDSTAR STRIPING REPAIR INSTRUCTIONS	b-6
b-4.2	GOLD LEAF RE-COATING INSTRUCTIONS	b-6
b-4.3	PAINT TOUCH-UP	b-6
b-4.4	PROFESSIONAL SURFACE RESTORATION	b-6



To the Owner and Operator

1-1. Who Should Use, Service, and Maintain This Vehicle

⚠ WARNING

Operating, servicing and maintaining this vehicle or equipment can expose you to chemicals including engine exhaust, carbon monoxide, phthalates, and lead, which are known to the State of California to cause cancer and birth defects or other reproductive harm.

To minimize exposure:

- Avoid breathing exhaust
- Do not idle the engine except as necessary
- Service your vehicle or equipment in a well-ventilated area
- Wear gloves or wash your hands frequently when servicing

For more information go to www.P65Warnings.ca.gov

⚠ WARNING

Only trained personnel should operate this equipment.

Do not operate or service until you have read and understood the operation and service manual supplied with this equipment.

Manuals can be obtained from manufacturer's website or by contacting customer service.

Operating this equipment without knowledge or training may lead to injury or death for you or others.

Some risks are associated with heavy vehicles due to the nature of their use. Personnel working in, on, or near these vehicles may be exposed to hazards that they cannot be fully protected from. Use intelligence, care, and common sense when working in, on, or around the vehicle.

Owners of this equipment must employ personnel who are physically and mentally competent, careful, and trained in the safe operation of this equipment.

The manual reviews basic principles of operation, highlights common safety concerns and procedures, and gives recommendations for using and maintaining the equipment.

This manual assumes that you:

- Have already been fully trained to operate the vehicle and equipment. Only trained personnel should operate this vehicle or perform maintenance.
- Have demonstrated the effectiveness of your training and the extent of your knowledge.

BEFORE operating this vehicle and equipment, you, the operator or maintainer, must read, understand, and follow the instructions found in this operator and maintenance manual and the operator and maintenance manuals from the manufacturers of major components used on this vehicle or equipment.

FOREWORD

Use proper tools, service equipment, and appropriate safety precautions to prevent personal injury and/ or equipment damage.

If you are uncertain about the safe operation of any aspect of this vehicle or equipment, stop immediately and seek further training.

You are the only person who knows what you don't know. You must speak up about the things you don't know, so you can learn about them before someone is injured or killed because of your lack of knowledge.

You are responsible for learning how to operate this vehicle and equipment under all conditions without having to pause to read this manual.

1-2. Vehicle Identification

Figure 1-1: FMVSS Information Decal

Mo./Yr of Mfg				Job No.		WO No.	
GVWR	KG (LB)		Tire-Limited Max Speed	mph	Chassis	
GAWR		TIRES		RIMS		COLD TIRE INFLATION	
Front	KG (LB)	(L)			kPa (PSI) SINGLE	
Rear	KG (LB)	(H)			kPa (PSI) DUAL	
<p>THIS VEHICLE CONFORMS TO ALL APPLICABLE U.S. FEDERAL MOTOR VEHICLE SAFETY STANDARDS IN EFFECT ON THE DATE OF MANUFACTURE SHOWN ABOVE.</p>							
VIN				TYPE			
CUSTOM HIGH GRADE PAINT FINISH							
Pierce No.				NA		NA	
Pierce No.				NA		NA	
<p align="center">FLUID CAPACITIES</p> <p align="center">Perform All Maintenance Items outlined in the Chassis Operation Manual At The Recommended Time Intervals</p>							
Device		Fluid Capacity			Fluid Type		
Engine		Liter		Quart			
Trans		Liter		Quart			
Coolant		Liter		Quart			
Power Steering		Liter		Quart			
Front Axle							
Rear Axle (#2 or Single)		Liter		Quart			
Rear Axle (#5)		Liter		Quart			
Cab Tilt		Liter		Quart			
Gen	None	Liter		Quart			
(Refer to Owners Manual for Temperature Ranges)							
T-Case		Liter		Quart			
Equipment Rack - Per Reservoir		Liter		Quart			
Comp		Liter		Quart			
Water Pump Transmission		Liter		Quart			
Water Pump Primer		Liter		Quart			



1099, POM0809

The Vehicle Identification Number (VIN) can be found in the upper right hand corner of the yellow Federal Motor Vehicle Safety Standard (FMVSS) information decal found in the driver's side of the cab.

1-3. Customer Assistance Information

Your satisfaction with your Pierce apparatus is important to your dealer and Pierce Manufacturing Inc. Normally, any question or concern you may have with your apparatus can be handled by your selling or servicing dealer. Your dealer has the facility, trained technicians, special tools, and up-to-date information to promptly address any issue that may arise. Pierce Manufacturing Inc. has empowered dealers to make decisions and repair vehicles, and they are eager to resolve your issues to your complete satisfaction. Should you encounter an issue with your Pierce apparatus that requires service, take the following steps:

Step 1.) Contact your authorized Pierce selling or servicing dealer. They will make the necessary arrangements to order the necessary parts and make the required repairs.

Step 2.) If they are not able to repair the problem to your satisfaction, discuss your concern with a member of dealer management. Normally, concerns can be quickly resolved at that level. If the matter has already been reviewed with the Sales, Service, or Parts Manager, contact the owner of the dealership or the General Manager.

Step 3.) If, after contacting a member of the dealership management, it appears your question or concern cannot be resolved by the dealership without further help, you may contact Pierce Manufacturing Inc. at 888-Y-PIERCE (888-974-3723).

1-4. Responsibility

Study carefully this manual and the manuals for major components such as engine, transmission, and other allied equipment. Make sure that all operators and other users also completely understand their contents.

The warnings, cautions, and procedures listed in these manuals must be part of the vehicle's safety program.

As the operator of this vehicle and equipment, you are responsible for:

- Understanding the function of each component of the vehicle.
- Understanding how to adjust each control to obtain the results you want.
- Maintaining control of the vehicle at all times.
- Remaining proficient in the use of the vehicle, so at a scene you can operate and make successful changes in the operation quickly, without having to read the operator's instructions or safety warning labels.

Practicing proper manual override and emergency shutdown procedures, so you can respond immediately in an emergency or during the failure of a component. Remember stress is high. Your failure to practice increases the odds you will forget or do it wrong in the heat of the moment.

1-5. Professional, Training, and Standards Organizations

To keep up-to-date on knowledge and new standards that affect all facets of fire fighting, make sure that you check these organizations' catalogues and websites each month:

National Fire Protection Association (for standards and requirements)

One Batterymarch Park
P.O. Box 9101
Quincy, MA 02269-9101
617-770-3000
www.nfpa.org

Make sure you read the latest editions.

Pierce Manufacturing Inc.

Customer Service
2600 American Drive
P.O. Box 2017
Appleton, WI, 54913
888-Y-PIERCE (888-974-3723)
www.piercemfg.com and www.pierceparts.com

International Fire Service Training Association (for textbooks and other training material)

Fire Protection Publications
Oklahoma State University
930 North Willis
Stillwater, OK 74079-8045
800-654-4055
www.ifsta.org



Safety and Responsibility

2-1. Warnings and Cautions

2-1.1 Warning and Caution Statements

Throughout this manual you will find warnings and cautions:

DANGER

DANGER signals an imminently hazardous situation that, if not avoided, will result in death or serious injury.

WARNING

WARNING signals a potentially hazardous situation that, if not avoided, could result in death or serious injury.

CAUTION

CAUTION with the safety triangle signals a potentially hazardous situation that, if not avoided, might result in minor or moderate injury.

CAUTION

CAUTION used without the safety triangle symbol signals a potentially hazardous situation that, if not avoided, might result in property damage.

Study this manual and the component operator manuals found in the service manual carefully and ensure that all operators and other users are fully familiar with their contents. The warnings, cautions, and procedures listed in these manuals must be incorporated into the safety program of the fire department to which the vehicle is assigned.

2-1.2 General Warnings and Cautions

⚠ WARNING
<p>Fire helmets shall not be worn by persons riding in enclosed driving and crew areas. Fire helmets are not designed for crash protection and they will interfere with the protection provided by head rests. The use of seat belts is essential to protecting fire fighters during driving. Failure to comply may result in serious injury or death to personnel.</p>
<p>Use extreme caution when walking or standing on vehicle. Areas for walking and/or standing that are located higher than 48 in. above the ground and unguarded by a railing or structure are designated by a safety line along the outside perimeter of the allowable standing/walking surface. Use extra caution in wet, icy, snowy, or muddy conditions. Failure to comply may result in slipping or falling - causing injury or death.</p>
<p>Care must always be taken when climbing on and off the vehicle. Always face the vehicle, use steps and grab handles, and maintain three points of contact with the vehicle (two feet/one hand or two hands/one foot). Keep steps, grab handles, and walkways clean. Be extra careful in wet, icy, snowy, or muddy conditions. Failure to comply may result in slipping or falling - causing injury or death.</p>
<p>Fire apparatus are often equipped with Power Take-Off (PTO) operated accessories. Never operate the engine with personnel in the vicinity of any driveshaft as they may engage without warning. Hands, clothes, hair, etc., can get caught on spinning shafts and U-joints. Failure to heed this warning may lead to personal injury or death.</p>
<p>Internal combustion engines give off hazardous fumes and gases while running. Do not operate the engine in an area where exhaust gases can accumulate, or serious injury or death may occur.</p>

2-1.3 Safety Warning Labels

This section is a summary listing of the most common safety labels placed on the vehicle to warn of potentially hazardous situations. Read and understand all labels before operating the vehicle. Practice all the time to avoid the hazard, so you develop a habit to avoid the hazard. Any lost or damaged labels must be replaced immediately.

Figure 2-1: Warning and Caution Labels



91-9026



91-9028



M0007



FAMA10



1756853



2707672



M0010

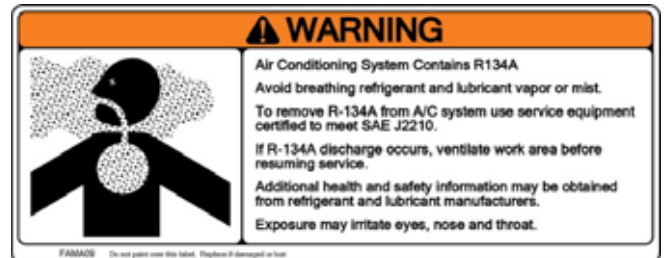

FAMA09



FAMA11



FAMA17



FAMA14



FAMA22



M0107





FAMA05

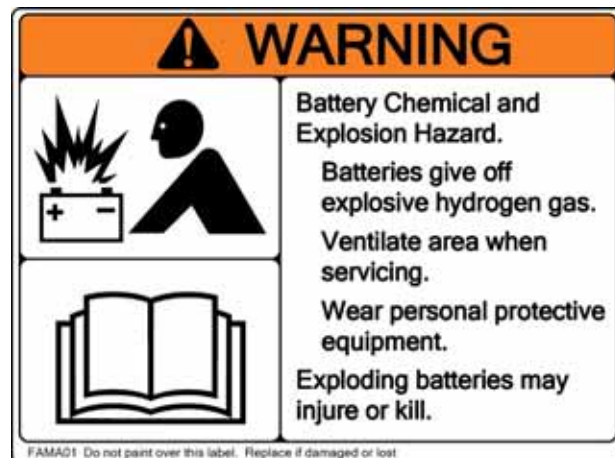

FAMA24



FAMA01

 DANGER		<p>Exhaust gets extremely HOT without warning. KEEP AWAY from exhaust gas. Do NOT Touch pipes or parts. Do not park near flammable objects. Hot metal and gas may burn skin or start fires.</p>
---	---	--

1931263

 CAUTION
<p>Air bags, seat belt pretensioners, and suspension seat pull-down devices have a life expectancy of 20 years.</p> <p>Replace devices within 20 years from the date of the vehicle manufacture as indicated on the VIN label.</p> <p>Expired devices may not provide protection in a crash.</p>

1797265

 CAUTION
<p>ENGINE AND TRANSMISSION PARAMETER SETTINGS MUST BE SAVED PRIOR TO UPDATING ENGINE OR TRANSMISSION ECU'S</p>

1976824

	 WARNING
<p>Knee bag deploys with great force in a crash. Do not place people or objects in path of bag. Objects flying from bad deployment can injure or kill. Inflatable restraints in this vehicle are not designed to protect children. Transport children in rear seating positions only.</p>	

1797262

 WARNING	
	<p>Sirens produce loud sounds that may damage hearing. Roll up windows. Wear hearing protection. Use only for emergency response. Avoid exposure to siren sound outside of vehicle.</p>

FAMA42

 WARNING	
	<p>Diesel engine exhaust and some of its constituents are known to the State of California to cause cancer, birth defects and other reproductive harm.</p>

2714750

 WARNING	
	<p>Crush Hazard. Stay clear of raised cab. Before working under cab engage prop support. Falling cab may injure or kill.</p>

FAMA41



FAMA15



FAMA12



2316278



M0263



M0278

2-2. Backing the Vehicle

⚠ WARNING**Backing Hazard.**

Ensure that personnel are clear before driving in reverse.

Always use a spotter when backing.

Backing vehicle without knowing what is behind you may injure or kill.

According to the National Safety Council, one out of four vehicle accidents can be blamed on poor backing techniques. The use of safe vehicle backing practices can help prevent injury or death to those around you.

- Get to know your vehicle's blind spots. In a medium-sized truck, blind spots can extend up to 16 feet in front and 160 feet behind a vehicle. Use a helper who can walk around your vehicle while it is parked to get to know when you can see them and when you can not. Remember that mirrors can never give the whole picture while backing.
- Think in advance. Whenever possible, avoid situations where you will need to back up.
- Park Defensively. Choose easy-exit parking spaces that don't crowd neighboring vehicles. Park in the center of the parking space. If parking in an alley, back into it so you are pulling forward onto the street when you leave.
- Do a walk-around before backing. Check for people, children, or obstructions in the area. Check for soft soil, potholes, tire hazards, low hanging trees or power lines, or other dangers.
- Use a spotter to assist when backing. The driver and spotter should use hand signals instead of verbal ones and make sure they understand each other's signals. Don't have the spotter walking backwards while giving instructions.
- If spotting for yourself, return to the vehicle and start backing within a few seconds after finishing the walk-around. This will allow very little time for people and or obstacles to change behind the vehicle. Only back without a spotter after gaining as much information as possible about what is behind you.
- Back-up alarms will help warn away pedestrians and drivers of other vehicles who may try to enter the area your vehicle is backing into. Always listen to be sure that your back-up alarm is working before proceeding backwards.
- No amount of forward driving experience will help you with backing a truck. You must practice in a safe area until you become familiar with the way your vehicle backs up compared to the direction the steering wheel is turned.

2-3. Vehicle Handling Characteristics

Safe operation of any vehicle is the responsibility of the driver. Heavy trucks have a significantly higher rollover tendency than other types of vehicles, due to a higher center of gravity. To reduce the risk of rollover, avoid making sharp turns at excessive speeds and other abrupt maneuvers. In the event of a rollover crash, an unbelted person is significantly more likely to become injured or die than a person wearing a seat belt. Unbuckled occupants can also become a hazard to other occupants as they may be thrown around inside the cab in the event of a crash. **ALWAYS BUCKLE UP.**

2-4. Electrocution Hazard from Overhead Power Lines

⚠ DANGER

Electrocution Hazard.

- **Vehicle is not insulated.**
- **Do NOT raise boom into power lines.**
- **Look up and use light to search for power lines in the dark.**
- **Keep boom and vehicle 10 ft. (3m) away from power lines.**
- **Do not step off a charged vehicle.**

Touching a charged vehicle while standing on the ground will result in death.

Overhead power lines are not insulated. Some lines have a weather covering and appear to be insulated, they are not. The vehicle or parts of the vehicle do not need to touch the power line for the vehicle to become energized. Electricity will arc across a gap as large as 10 feet, and all overhead wires or cables should be considered hazardous and dangerous. Follow these guidelines when working in the vicinity of power lines.

- Make sure the work area is clear of major obstacles and overhead obstructions.
- Do not work within 10 feet of high-voltage lines energized from 600 to 50,000 volts. It is the law. The operator can be liable if activities in violation of this law cause injury or property damage.
- Only operate in conditions where the vehicle and equipment can be stabilized. Do not set up or operate on soft soil, mud, snow or other unstable ground conditions that could allow the vehicle or equipment to shift and move within 10 feet of a power line.
- Always check the operating vicinity for power lines before you drive into it. Tree branches can hide power lines or cables from view. If operating at night, use powerful lights to search for power lines or poles.

If you are on or inside a vehicle that contacts or is energized by a power line, stay where you are. Exiting the vehicle is more hazardous than remaining inside. Unless there is a fire, it is safest to stay in the vehicle than to attempt an exit. Stay in or on the vehicle until a power company representative informs you that the line has been de-energized and grounded and that the area is safe.

If it is critical that you leave the vehicle, JUMP as far away as possible landing with both feet together. Maintain balance or fall forward, don't fall back toward the vehicle which could result in the body becoming a pathway between the vehicle and the ground. No part of your body should touch the vehicle and the ground at the same time.

If you are outside of the vehicle that contacts or is energized by a power line, move away from the vehicle and stay away. Warn others to stay away. You are safe from electrical shock as long as you do not become a pathway for current to flow to the ground. Do not approach the vehicle until a power company representative informs you that the line has been de-energized and grounded and that the area is safe.

In certain circumstances the ground around a charged vehicle or downed power line may be energized. The ground becomes charged in concentric circles around the vehicle with varying voltage potential. Straddling these bands can result in serious injury or death as the current passes through your body. Stay away from the vehicle or power line, keeping both feet on the ground at the same time. This will prevent you from becoming a conductor between two areas of the ground that are charged differently.

If someone is trapped inside a vehicle that has come in contact with a power line, instruct them to stay inside and not to try to exit, unless their life is in eminent danger or a fire is present. Call 911 immediately and instruct the 911 operator to contact the power company. The power company personnel are trained to eliminate the hazard to by de-energizing the line.

Do not attempt any rescue of a person on or inside an energized vehicle, or who is energized themselves. If you touch someone whose body is conducting current, the current will flow through you too. Your muscles will seize up and you will not be able to escape.

2-5. High Pressure Hydraulic Fluid

DANGER

High Pressure Fluid Hazard.

- High pressure fluid leak will pierce skin.
- Release pressure before working on system.
- Detect leaks with wood or cardboard. Wear sturdy gloves and goggles. NEVER use fingers.
- Fluid injected into skin must be surgically removed by trained doctors immediately or gangrene will result.

Fluid injected into skin will injure or kill.

Certain equipment on this vehicle may be powered by high pressure hydraulic fluid. High pressure hydraulic fluid leaks are dangerous. If you see a hydraulic leak, shut down the equipment and call in a service technician trained in safe methods of trouble-shooting and servicing hydraulic power equipment.

NEVER search for leaks with your hands or other body parts. High pressure hydraulic fluid at pressures as low as 100 psi can penetrate skin. Use a piece of wood or cardboard to detect leaks, keeping hands and other body parts well away from the potential source of the leak.

If you suspect that you have been exposed to a high pressure hydraulic fluid skin penetration, seek medical help immediately. The high pressure injection of a fluid such as hydraulic oil, grease and paint is a medical and surgical emergency. Treatment is required as soon as possible. Often the injury appears minor. Don't be fooled. Fluids injected under the skin are highly toxic. The injury will lead to gangrene, amputation, and death if not treated promptly.

Most Doctors are not trained in treating hydraulic related injuries. Make sure they are aware of the potential problems and get the recommend treatment needed to treat the injury.

2-6. Tanker (Mobile Water Supply) Truck Characteristics

2-6.1 Description of Hazard

Mobile water supply vehicles, known as tankers or tenders, are widely used to transport water to areas beyond a water supply system or where the water supply is inadequate. Incidents involving motor vehicles account for approximately 20% of U.S. fire fighter deaths each year; cases involving tankers are the most prevalent of these motor vehicle incidents. During 1977-1999, 73 deaths occurred in 63 crashes involving tankers. Of those deaths, 54 occurred in 49 crashes in which tankers rolled over (no collision), and 8 occurred in 6 crashes in which the tankers left the road (no collision). The other cases involved collision with another vehicle (10 deaths in 7 crashes) and collision with stationary object(s) (1 death) [NFPA 2000].

Tanker drivers may not be fully aware that tanker trucks are more difficult to control than passenger vehicles. A tanker truck requires a much greater distance to stop. Tankers weigh substantially more, and their air brake systems take more time to activate than the hydraulic/mechanical brake systems on smaller passenger cars. The effect is influenced by the amount of water the tanker is hauling and whether the tanker is baffled.

2-6.2 Recommendations for Prevention

To reduce the risk of tanker truck rollovers, the National Institute for Occupational Safety and Health (NIOSH) recommends that fire departments take the following precautions:

- Develop, implement, and enforce standard operating procedures (SOPs) for emergency vehicles - particularly with regard to the use of seat belts.
- Ensure that drivers have necessary driving skills and experience and provide them with periodic refresher training.
- Consider terrain, weather, and bridge and road conditions when purchasing a mobile water supply vehicle.
- Adhere to the requirements of NFPA 1915 for keeping a vehicle on a maintenance schedule and documenting the performance of the maintenance [NFPA 2001].
- Inspect the complete vehicle at least once per year to comply with Federal and State motor vehicle regulations.
- Adhere to the requirements of NFPA 1901 for an approved mobile supply vehicle [NFPA 2001].
- Equip all vehicles with seat belts.
- Ensure that water tank capacity is adequate and has proper tank mounting and sufficient front and rear weight distribution.
- Ensure that the weight of the fully loaded vehicle does not exceed the gross axle weight rating of any axle and the gross vehicle weight rating of the chassis.
- Ensure that the center of gravity of the vehicle does not exceed the chassis manufacturer's specified center of gravity.
- Provide proper baffles to control water movement for all vehicles equipped with water tanks.
- Verify that vehicles are of proper design and have adequate suspension, steering and braking ability.

2-6.2a All Drivers Should Do the Following

- Recognize that they are responsible for the safe and prudent operation of the vehicle under all conditions.
- Wear a seat belt when operating a vehicle.
- Take training to meet the job performance requirements stated in NFPA 1102 before driving and operating the vehicle [NFPA 2001].
- Take refresher driver training at least twice per year.
- Understand the vehicle characteristics, capabilities, and limitations.
- Be aware of the potential for unpredictable driving by the public (excessive speed, failure to yield to emergency vehicles, inattentiveness, etc.).
- Adjust speed when driving on wet or icy roads, in darkness or fog, or under any other conditions that make emergency vehicle operation especially hazardous.

2-7. Lockout/Tagout

⚠ DANGER

Stored Energy or Start-Up Hazard.

Follow OSHA lockout/tagout standard 29 CFR 1910.147 before:

- **Maintaining or servicing.**
- **Working in, on, under or around vehicle equipment.**

Failure to comply may result in serious injury or death.

Some maintenance or service procedures may require lockout / tagout (LOTO) to protect service personnel from injury from an accidental vehicle start-up or energizing the electrical system.

OSHA lockout/tagout standard 29 CFR 1910.147 covers the servicing and maintenance of machines and equipment. The unexpected energizing or start up of the machines or equipment, or release of stored energy, could harm employees. This standard establishes minimum performance requirements for the control of such hazards.

Employers should create procedures to prevent vehicle start-up, energizing, or the release of stored energy, during servicing. These procedures should use lockout or tagout devices.

LOTO procedures shall be clear and specifically outline the scope, purpose, authorization, rules, and techniques for the control of hazardous energy. They should include the means to enforce compliance. This should include, but not be limited to, the following:

- A specific statement of the procedure and its use.
- Specific steps for shutting down, isolating, blocking and securing machines or equipment to control hazardous energy.
- Specific steps for the placement, removal and transfer of lockout devices or tagout devices and the responsibility for them.
- Specific requirements for testing a machine or equipment to determine and verify the effectiveness of lockout devices, tagout devices, and other energy control measures.

2-8. Safety Defect Reporting

If you believe that your vehicle has a defect that could cause a crash or could cause serious injury or death, it should be reported immediately to the National Highway Traffic Safety Administration (NHTSA) and to Pierce Manufacturing Inc. If NHTSA receives a number of similar complaints, it may open an investigation. If the investigation reveals a latent safety defect, NHTSA may order a recall and remedy campaign. NHTSA will not become involved in individual complaints between customers, dealers, and manufacturers.

To contact NHTSA, call the Auto Safety Hotline at 1-800-424-9393 or write to NHTSA, U.S. Department of Transportation, Washington, D.C. 20590.



Axles, Tires, and Brakes

3-1. Axle Weights and Axle Capacity

⚠ WARNING

Never exceed the gross axle weight ratings printed on the label inside the cab. Exceeding these ratings could lead to reduced component life, personal injury, or death.

Due to the highly custom nature of fire apparatus, it is very important to consider weight distribution and axle capacity during the specification stage of the procurement procedure. Before shipment, every Pierce fire apparatus is weighed with all loose equipment removed to ensure that the axle, suspension, tire, and wheel capacities provide for the applicable NFPA allowances of occupants and payload capacity. As it is impossible to predict the manner in which the vehicle will be loaded after delivery, Pierce assumes that allowances for personnel will be centered over the front axle, while the combined effect of hose load and equipment allowances will be centered over the rear axle.

Before placing the apparatus in service, load all compartments with the intended equipment and manpower, and obtain front and rear axle weights from a certified scale. Compare the results to the axle capacities listed on the Federal Motor Vehicle Safety Standard (FMVSS) information decal located inside the cab. In-service weights must not exceed the axle capacities listed on the tag.

3-2. Tire Pressure

⚠ WARNING

Maintain tire pressure at the tire manufacturer's pressure recommendations for the correct tire size, type, load range (ply rating), and measured in-service axle load of the vehicle. Failure to maintain proper tire pressure may result in loss of vehicle control, property damage, personal injury, or death.

When checking air pressure or inflating/deflating tires, always use the following:

- A clip-on chuck.
- An in-line valve with a pressure gauge or a pre-settable regulator.
- A sufficient length of hose between the clip-on chuck and in-line valve (if one is used) to allow personnel to stand outside the trajectory area.

Tire pressure should be checked while the tire is cold. Tires that are heated through use may have a 15 psi (103 kPa) higher rating.

⚠ CAUTION

When adding air to a tire, the air must come from an air system that is equipped with a water separator. Failure to comply may result in water or moisture being added to the wheel/tire assembly. Water or moisture inside the wheel/tire assembly can cause rust and corrosion to the wheel components.

Proper tire inflation is essential to safe vehicle performance and handling. Tire inflation pressure must match the weight on each axle. Before placing the vehicle in service, obtain the axle weights with all equipment loaded and tanks full. Adjust the tire pressure to match the tire loads. See *"Tire Inflation"* on [page 6-44](#) for proper tire pressure settings. Once all of the tires are inflated to the proper air pressure, install on each tire the LED Air Guard™ tire pressure management system valve caps (*if equipped*) that were shipped loose with your apparatus.

3-3. Brake Balance

All Pierce Custom Chassis are configured to provide properly matched drive-train components at the maximum axle capacities listed on the tag located inside the cab. Brake operation in fire apparatus service is unique to the trucking industry because of the high horsepower to weight ratios, high acceleration, high speed, and hard braking involved in emergency use. To account for this duty cycle, brakes employed on fire apparatus use more aggressive lining materials than is common in over-the-road cargo haulers. These linings provide the brake performance required, but are more sensitive to under-loaded conditions

Before placing the apparatus in service, load all compartments with the intended equipment and manpower, and obtain front and rear axle weights from a certified scale. Compare the results to the axle capacities and axle model numbers listed on the Federal Motor Vehicle Safety Standard (FMVSS) information decal located inside the cab. Refer to the brake power charts to ensure that the brake power will fall within the appropriate guidelines. Brake power is indicated on the chart by the size of the chamber in square inches (24, 30, or 36) followed by the slack adjuster length in inches (5.5 or 6.0).

The proper chart must be referenced based upon the brake type on each axle:

Table 3-1: Brake Power Chart Reference Table

	Front Axle	Rear Axle
Figure 3-1	Cam Brakes	Cam Brakes
Figure 3-2	Disc Brakes	Cam Brakes
Figure 3-3	Disc Brakes	Disc Brakes

Brake chamber size is stamped on the components themselves. Slack adjuster length can be determined directly by measuring between the camshaft center and the large clevis pin. Any modification to the brakes to balance the system by reducing brake power must be accompanied by a revision to the Federal Motor Vehicle Safety Standard (FMVSS) information decal (contact Pierce Customer Service for revised tags).

Figure 3-1: Brake Power Chart (Cam Brakes on Front and Rear Axles)

		FRONT				
In-Service Axle Weights (Lb.)		11,000-14,600	14,601-16,540	16,541-18,000	18,001-21,500	
Axle Model		FG941	RF16-145, FL941/FL943			
REAR	14,000-17,000	RS21 Front:24 x 5-1/2 Rear:24 x 5-1/2	Front:24 x 5-1/2 Rear:24 x 5-1/2			
	17,001-21,000	RS21 Front:24 x 5-1/2 Rear:30 x 5-1/2	Front:30 x 5-1/2 Rear:30 x 5-1/2	Front:30 x 5-1/2 Rear:30 x 5-1/2	Front:30 x 5-1/2 Rear:30 x 5-1/2	
	21,001-24,000	RS23 Front:24 x 5-1/2 Rear:30 x 5-1/2	Front:30 x 5-1/2 Rear:30 x 5-1/2	Front:30 x 5-1/2 Rear:30 x 5-1/2	Front:30 x 5-1/2 Rear:30 x 6	
	24,001-27,000	RS25 Front:30 x 5-1/2 Rear:30 x 6	Front:30 x 5-1/2 Rear:30 x 6	Front:30 x 5-1/2 Rear:30 x 6	Front:30 x 5-1/2 Rear:30 x 6	
	27,001-31,000	RS30 Front:30 x 5-1/2 Rear:36 x 6	Front:30 x 5-1/2 Rear:36 x 6	Front:30 x 5-1/2 Rear:36 x 6	Front:30 x 5-1/2 Rear:36 x 6	
	34,000-42,000	RT34 RT40 Front:24 x 5-1/2 Rear:30 x 5-1/2	Front:30 x 5-1/2 Rear:30 x 5-1/2	Front:30 x 5-1/2 Rear:30 x 5-1/2	Front:30 x 5-1/2 Rear:30 x 5-1/2	
	42,001-48,000	RT44 RT46 Front:24 x 5-1/2 Rear:30 x 5-1/2	Front:30 x 5-1/2 Rear:30 x 5-1/2	Front:30 x 5-1/2 Rear:30 x 5-1/2	Front:30 x 5-1/2 Rear:30 x 6	
	48,001-54,000	RT52 Front:30 x 5-1/2 Rear:30 x 6	Front:30 x 5-1/2 Rear:30 x 6	Front:30 x 5-1/2 Rear:30 x 6	Front:30 x 5-1/2 Rear:30 x 6	
	54,001-58,000	RT58		Front:30 x 5-1/2 Rear:36 x 6	Front:30 x 5-1/2 Rear:36 x 6	Front:30 x 5-1/2 Rear:36 x 6

POM0039

Figure 3-2: Brake Power Chart (Disc Brakes Front, Cam Brakes Rear)

		FRONT				
In-Service Axle Weights (Lb.)		11,000-14,600	14,601-16,540	16,541-18,000	18,001-21,500	
Axle Model		FG941	FL941/FL943			
REAR	14,000-17,000	RS21	Front:24 x 5-1/2 Rear:24 x 5-1/2	Front:24 x 5-1/2 Rear:24 x 5-1/2		
	17,001-21,000	RS21	Front:24 x 5-1/2 Rear:30 x 5-1/2	Front:24 x 5-1/2 Rear:30 x 5-1/2	Front:30 x 5-1/2 Rear:30 x 5-1/2	Front:30 x 5-1/2 Rear:30 x 5-1/2
	21,001-24,000	RS23	Front:24 x 5-1/2 Rear:30 x 5-1/2	Front:24 x 5-1/2 Rear:30 x 5-1/2	Front:30 x 5-1/2 Rear:30 x 5-1/2	Front:30 x 5-1/2 Rear:30 x 6
	24,001-27,000	RS25	Front:24 x 5-1/2 Rear:30 x 6	Front:24 x 5-1/2 Rear:30 x 6	Front:30 x 5-1/2 Rear:30 x 6	Front:30 x 5-1/2 Rear:30 x 6
	27,001-31,000	RS30	Front:24 x 5-1/2 Rear:36 x 6	Front:24 x 5-1/2 Rear:36 x 6	Front:30 x 5-1/2 Rear:36 x 6	Front:30 x 5-1/2 Rear:36 x 6
	34,000-42,000	RT34 RT40	Front:24 x 5-1/2 Rear:30 x 5-1/2	Front:24 x 5-1/2 Rear:30 x 5-1/2	Front:30 x 5-1/2 Rear:30 x 5-1/2	Front:30 x 5-1/2 Rear:30 x 5-1/2
	42,001-48,000	RT44 RT46	Front:24 x 5-1/2 Rear:30 x 5-1/2	Front:24 x 5-1/2 Rear:30 x 5-1/2	Front:30 x 5-1/2 Rear:30 x 5-1/2	Front:30 x 5-1/2 Rear:30 x 6
	48,001-54,000	RT52	Front:24 x 5-1/2 Rear:30 x 6	Front:24 x 5-1/2 Rear:30 x 6	Front:30 x 5-1/2 Rear:30 x 6	Front:30 x 5-1/2 Rear:30 x 6
	54,001-58,000	RT58		Front:24 x 5-1/2 Rear:36 x 6	Front:30 x 5-1/2 Rear:36 x 6	Front:30 x 5-1/2 Rear:36 x 6

POM0040

Figure 3-3: Brake Power Chart (Disc Brakes Front, Disc Brakes Rear)

		FRONT				
In-Service Axle Weights (Lb.)		11,000-14,600	14,601-16,540	16,541-18,000	18,001-21,500	
Axle Model		FG941	FL941/FL943			
REAR	14,600-17,000	RS21	Front:24 x 5-1/2 Rear:24 x 5-1/2	Front:24 x 5-1/2 Rear:24 x 5-1/2		
	17,001-22,000	RS21	Front:24 x 5-1/2 Rear:30 x 5-1/2	Front:24 x 5-1/2 Rear:30 x 5-1/2	Front:30 x 5-1/2 Rear:30 x 5-1/2	Front:30 x 5-1/2 Rear:30 x 5-1/2
	22,001-24,000	RS23	Front:24 x 5-1/2 Rear:30 x 5-1/2	Front:24 x 5-1/2 Rear:30 x 5-1/2	Front:30 x 5-1/2 Rear:30 x 5-1/2	Front:30 x 5-1/2 Rear:30 x 5-1/2
	24,001-27,000	RS25				
	27,001-31,000	RS30				
	34,000-42,000	RT34 RT40	Front:24 x 5-1/2 Rear:30 x 5-1/2	Front:24 x 5-1/2 Rear:30 x 5-1/2	Front:30 x 5-1/2 Rear:30 x 5-1/2	Front:30 x 5-1/2 Rear:30 x 5-1/2
	42,001-48,000	RT44 RT46	Front:24 x 5-1/2 Rear:30 x 5-1/2	Front:24 x 5-1/2 Rear:30 x 5-1/2	Front:30 x 5-1/2 Rear:30 x 5-1/2	Front:30 x 5-1/2 Rear:30 x 5-1/2
	48,001-54,000	RT52				

POM0041

Figure 3-4: Brake Power Chart (Disc Brakes Front, ALL STEER® Cam Brakes Rear)

		FRONT						
In-Service Axle Weights (Lb.)		11,000-14,600	14,601-16,540	16,541-18,000	18,001-18,999	19,000-20,000	20,001-21,500	
Axle Model		FG941	FL941/FL943					
REAR	17,000-21,500	AWS21.5	Front:24 x 5-1/2 Rear:30 x 5-1/2	Front:24 x 5-1/2 Rear:30 x 5-1/2	Front:24 x 5-1/2 Rear:30 x 5-1/2	Front:24 x 5-1/2 Rear:30 x 5-1/2		
	21,501-24,000	AWS24	Front:24 x 5-1/2 Rear:30 x 6	Front:24 x 5-1/2 Rear:30 x 6	Front:24 x 5-1/2 Rear:30 x 6	Front:24 x 5-1/2 Rear:30 x 6		
	24,001-26,000	AWS26	Front:24 x 5-1/2 Rear:30 x 6	Front:24 x 5-1/2 Rear:30 x 6	Front:24 x 5-1/2 Rear:30 x 6	Front:24 x 5-1/2 Rear:30 x 6	Front:24 x 5-1/2 Rear:30 x 6	Front:30 x 5-1/2 Rear:30 x 6
	34,000-42,000	AWS42	Front:24 x 5-1/2 Rear:30 x 5-1/2	Front:24 x 5-1/2 Rear:30 x 5-1/2	Front:24 x 5-1/2 Rear:30 x 5-1/2	Front:24 x 5-1/2 Rear:30 x 5-1/2	Front:24 x 5-1/2 Rear:30 x 5-1/2	Front:30 x 5-1/2 Rear:30 x 5-1/2
	42,001-48,000	AWS48	Front:24 x 5-1/2 Rear:30 x 6	Front:24 x 5-1/2 Rear:30 x 6	Front:24 x 5-1/2 Rear:30 x 6	Front:24 x 5-1/2 Rear:30 x 6	Front:24 x 5-1/2 Rear:30 x 6	Front:30 x 5-1/2 Rear:30 x 6
	48,001-52,000	AWS52	Front:24 x 5-1/2 Rear:30 x 6	Front:24 x 5-1/2 Rear:30 x 6	Front:24 x 5-1/2 Rear:30 x 6	Front:24 x 5-1/2 Rear:30 x 6	Front:24 x 5-1/2 Rear:30 x 6	Front:30 x 5-1/2 Rear:30 x 6

POM0042

3-4. Brake Burnishing

3-4.1 General Information

IMPORTANT: Brake noise is an inevitable characteristic of heavy-duty truck brakes with aggressive friction materials. Total elimination of all brake noise in heavy truck brakes cannot be expected.

Brakes shoes and pads are most effective after they have been worn-in sufficiently so that the surface of the friction material mates consistently with the drum or rotor surface. The process of wearing-in the friction material is termed “burnishing.” Braking performance and grade holding ability will improve once the brakes are burnished. The following burnish procedure is recommended by the axle and brake manufacturer to optimize brake performance and minimize the possibility of developing brake squeal or vibration.

Pierce recommends a burnishing procedure be done after a new truck has been delivered and has been loaded to its in service weight. This same practice should also be done after new brakes, disc brake pads or drum brake shoes have been installed. This will ensure that they are broken in properly and will give proper performance during stopping and grade holding.

3-4.2 Procedure



Make sure the driving route is in a safe, low traffic area.

Before starting the brake burnish procedure, make sure the brake chamber slack adjuster strokes, both free and applied, are within the brake supplier specifications. For brakes without slack adjusters, ensure that the caliper running clearance is correct. Refer to the axle manufacturer’s maintenance manual (included in the Pierce Service Manual) for maintenance schedules, lubrication recommendations, and inspection procedures.

BEFORE PLACING VEHICLE IN SERVICE

The brake burnish procedure is called 10/30/30 and 5.

Under safe conditions, make 10 stops from 30 mph with a 30 second interval of time between each stop to allow the brakes to cool slightly. The time it should take to stop from 30 mph to 0 mph is 5 seconds. This will equate to a gentle stop. Repeat this process up to three times if necessary, allowing sufficient time to cool between sessions.

During the burnishing procedure for new pads or shoes, it is common to smell the resins coming out of the lining material. This odor may disappear near the end of the burnish or shortly after the truck goes into service.

The brakes may also appear to be smoking. Again, these are the resins and other organic materials getting baked out of the linings. If you suspect one of the brakes is not performing the way it should, measure the brake rotor or drum temperature using an infrared hand held thermometer.

The infrared thermometer readings can vary depending on the location of the infrared beam on the object. Try to get within 12 inches of the drum or rotor and always try to check the same area of the component. Brake temperatures can vary from side to side on an axle as well as axle to axle. Try not to exceed 700° F (371.1° C). After the burnishing is complete, allow the brakes to cool completely to ambient temperature. All wheel-end brake actuation should be checked prior to putting the vehicle back in service.

Following this procedure should provide sufficient burnishing of the brakes and allow the truck brakes to perform as intended. Contact Pierce Customer Service if you have any questions or concerns regarding the brake system or performance.

Equipment, Accessories, and Adjustments

3-5. Carwell Removal

Carwell is normally applied to the underside of the vehicle as it leaves Pierce in the winter months between November 1st and April 1st. In this case, removal is not required prior to customer delivery.

If you ask that the entire vehicle to be coated for transport (*optional*), then follow the procedure below for removal from the outside of the vehicle prior to delivery. Remember that Carwell can attract dirt so do not use brushes when washing the truck.

- a. Wash the area using a mild detergent designed for washing vehicles, using a pressure washer. Water temperatures should be between 100°F-200°F and the pressure should be between 2,000 and 3,500 psi. As always, keep the tip at least 18-24 inches away so you don't damage the surface and graphics.
- b. Rinse thoroughly.

NOTE: If you are planning on doing paint repair or graphics on the outside of the truck, follow this procedure:

- Wash and rinse as stated above.
- Use an environmentally approved biodegradable mild degreaser and follow their directions for application and removal.

3-6. Customer-Installed Equipment

3-6.1 Modification

⚠ WARNING

Equipment Failure Related Hazards

Never change, alter, or modify this original equipment.

Unauthorized changes, modifications or alterations may affect the safety or reliability of this vehicle which may lead to personal injury or death.

This apparatus has been designed and manufactured to conform to criteria including government regulations and company standards. Any change, alteration, addition to, or removal from the original equipment or components, made in such a manner that the changed or altered portions or functions of the equipment or components are different from the manufacturer's original design, specification, or use requires written consent from this manufacturer.

3-6.2 Drilling Holes or Welding

The drilling of holes or welding to any structural components of the aerial is not permitted. Non-structural sheet metal components may be modified. If in doubt, contact Pierce Manufacturing Inc. for approval and assistance. Pierce Manufacturing Inc. is not responsible for structural failures or corrosion caused by unauthorized modifications to the aerial device.

3-6.3 Dissimilar Metal Corrosion

Galvanic corrosion can occur when two different types of metals are in contact with each other and exposed to moisture. This type of corrosion can happen rapidly, leading to possible failure of the mounting, fastener, or base materials. When mounting aftermarket equipment on the vehicle, consider the types of metals of the equipment, base, and fasteners. Take precautions to prevent contact between different metal types. Refer to *“Preventing Dissimilar Metal Corrosion”* on [page B-5](#) for more information on proper prevention of galvanic corrosion.

3-7. Radio Equipment

Refer to the *“Mobile Radio Installation Guide”* on [page A-1](#) for information concerning radio installation in a Pierce fire apparatus.

3-7.1 Cab Exterior Equipment

Avoid mounting hose or equipment in a manner that blocks airflow to the grill. Large items blocking air to the grill may degrade cooling performance and cause the engine to over-heat during heavy use and high ambient temperatures. Logos, letters, numbers, or placards should not be attached to the radiator grill. Numbers, letters, flags, etc., that are painted on the grill are acceptable.

When mounting equipment to the bumper deck plate of a tilt cab model, consider the motion of the cab when tilting to avoid interference in the tilted condition.

3-7.2 Cab Interior Equipment

WARNING

Installation of equipment in the deployment path of the first officer's knee air bag can result in improper deployment, serious injury or death in the event of a collision. No part of any equipment may extend within the area shown below, extending 4" outward from all sides of the knee air bag.

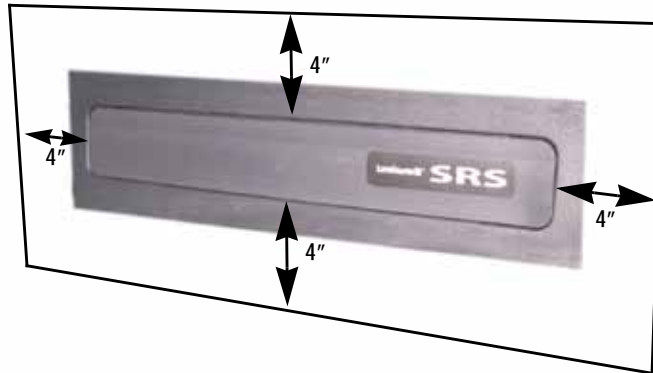

1186

When installing equipment in trucks equipped with Frontal Impact Protection, it is critical that equipment not be mounted in the deployment path of the air bags. Additionally, no equipment should be placed in the area between the first officer and the dashboard.

Consider the effect of cab-tilt on equipment storage to avoid damage from items falling forward when the cab is tilted for service or maintenance.

Monitor the weight of items installed in a tilt-cab, or stored in tilt-cab storage areas. Too much weight inside the cab may prevent the cab from being tilted for service or maintenance.

WARNING

Always stow work surface while vehicle is in motion. Never ride in the seat unless the work surface is stowed. Impact with the work surface during a crash will injure or kill.

Refer to NFPA guidelines when mounting equipment inside the cab to avoid unnecessary risk of injury from flying objects during a collision.

Exercise caution when drilling into cab walls, body walls, and headliners when mounting equipment, as there may be wiring, heater hoses, or air conditioning hoses hidden beneath the surface.

3-7.3 Air Pressure Operated Equipment

▲ WARNING

Pressure protection valves are installed in both front and rear brake systems to ensure that no other air pressure requirements of the vehicle are allowed to deplete the vehicle braking system capabilities. Addition of any air pressure equipment added by the end user upstream of these pressure protection valves will negate the conformance of the vehicle to this NFPA recommendation and property damage, personal injury, or death could result.

- Any air-operated equipment must only be added to the air system downstream of a pressure protection valve.
- Consider the airflow requirements of any air-operated accessory that will draw pressure from the vehicle system. The air compressor output with the engine at idle is a fraction of its total capacity and will not keep up with continuous operation of most shop-type air tools.

3-8. Equipment and Cargo Loading

▲ WARNING

Excessively uneven loading from side to side (greater than 550 lbs) can cause the vehicle to pull to one side during braking and/or produce a reduction in the rollover threshold of the vehicle. Operation of an improperly loaded vehicle could lead to loss of vehicle control causing property damage, serious personal injury, or death.

▲ CAUTION

NFPA standards specify that “All equipment required to be used during an emergency response shall be securely fastened”. Equipment not needed during the response must be secured to 9 Gs. Items not secured can injure or kill during a crash.

Every Pierce custom fire truck is measured prior to leaving the factory to ensure that it sits level. Since the apparatus may be configured with heavier options on one side or the other, it may be equipped with factory-installed shims at the time of delivery. As the compartments are filled with equipment of varying weight, the initial weight distribution will change, which may cause the truck to lean. The amount of lean depends on the spring rate of the suspension. Vehicles with higher capacity suspensions will lean less when subjected to the same variation in weight.

To ensure that a vehicle does not lean objectionably, careful consideration must be given to the weight and location of equipment. The following guidelines will help level a vehicle that has an objectionable lean:

- Check tire pressure and tread condition. Tire pressure and tread wear can affect vehicle height by as much as +/- 0.25 inches. Ensure that all tires are inflated to recommended pressures and that tread wear is reasonably even from side to side.
- Inspect the vehicle on a surface that is both flat and level. Keep in mind that the variations in height are generally measured in fractions of an inch. The tolerance of concrete and asphalt surfaces over the length and width of fire apparatus are rarely within the limits required to provide accurate measurements.
- Transfer load. Balance the spring loading by shifting equipment from the low side to the high side of the vehicle. Relocate heavy equipment closer to the longitudinal center of the vehicle whenever possible.

NFPA 1901 and 1906 specify that the apparatus when placed in service shall have a side-to-side tire load variation of no more than 7% of the total tire load for that axle.

The projections of total equipment payload and mounting locations are essential for proper engineering of a new fire apparatus. The purchaser of the fire apparatus should maintain the side-to-side loading requirement in (NFPA) 4.13.3.3 as equipment is loaded or installed on the apparatus. The percentage difference in side-to-side tire load should be calculated as shown in the following formula:

$$\frac{(\text{Heavier weight} - \text{Lighter weight})}{\text{Total weight}} \times 100 = \text{Percent difference}$$

After loading the apparatus to its in-service condition, weigh each wheel position independently to ensure that the side-to-side specification is met. If the variation exceeds 7%, shift the load in the compartments until the specification is met.

3-9. Front Spring/Suspension Adjustment

Refer to the following paragraphs for front spring/suspension adjustment information (if needed after equipment and cargo has been loaded).

3-9.1 TAK-4™ Independent Front Suspension

Information concerning the ride height adjustment of the TAK-4™ Independent Front Suspension can be found in the Pierce Service Manual, group 0152-P-007, TAK-4™ Torsion Bar Assembly.

3-9.2 Leaf Spring Suspension

⚠ WARNING

Excessive shimming of the front axle can adversely affect steering and braking performance.

- Remove factory installed shims. It is likely that any lean induced by the weight from factory installed options such as ladder racks, high side compartments, and generators was corrected before the vehicle left Pierce by adding shims between the spring pack and the axle pad. This action, although necessary to provide a level product as delivered, may complicate the leveling process once equipment is added. If accurate scale measurements indicated that the unit is equally loaded from side to side and an objectionable lean persists, inspect each spring for the presence of shims. These shims may be removed to reduce the lean if they are located on one of the high side springs.
- Adding shims. If all the above actions have been taken and an objectionable lean still persists, additional shims may be installed on the low side of the vehicle. Shim thickness should not exceed 0.50 inches on the front and 1.00 inches on the rear. Appropriate shim stock may be ordered from the Pierce customer service department. Shims must be installed in a manner that maintains the locating pin function between the axle and the springs. U-bolts should be re-tightened to the specified torque after 500 miles of road operation. Contact Pierce Customer Service concerning any shimming beyond these guidelines.

3-10. Rear Spring/Suspension Adjustment

3-10.1 TAK-4™ Independent Rear Suspension

Information concerning the ride height adjustment of the optional TAK-4™ Independent Rear Suspension can be found in the Pierce Service Manual, group 0202-P-011, TAK-4™ Anti-Sway Bar.

3-11. Suspension

Truck suspensions are designed to absorb high forces from road irregularities, steering inputs, and variations in load. Certain aspects of suspensions will naturally "wear in" during the first few miles of operation under load. Truck springs will wear off the high spots between the leaves, friction rates will drop off, and the ride height will settle in. In most cases a leaf spring pack will settle by up to 0.50 inches in the first few hundred miles. This settling phenomenon can also cause certain suspension fasteners to require tightening.

3-11.1 Spring Suspensions (*Spring U-Bolts*)

Spring suspension U-bolts must be tightened to the proper torque after approximately 500 miles of initial use. See "[Spring Suspension \(Front and Rear\)](#)" on [page 6-13](#). Ensure that this procedure has been completed prior to placing the unit in service. Check other suspension related fasteners and torque as required.

3-11.2 Air and Rubber Suspensions

Like spring suspensions, road shock and vibration can cause some initial settling of components. Certain suspensions do require a re-torquing procedure after the first 500 miles. Refer to the suspension manufacturers service information for any pre-delivery inspection or torquing requirements.



Safe Vehicle Entry and Exit

4-1. Vehicle Access

⚠ WARNING

Failure to exercise due care when entering and exiting vehicles can result in personal injury. Entry and exit should be made slowly, deliberately, and carefully.

A three-point stance should be used (three out of four extremities should be in contact with the vehicle at all times). Face inward toward steps and hand-holds when entering and exiting. Always keep steps and hand-holds in continuous good repair. Make sure all attaching bolts and hardware are tight, thus eliminating any movement of steps and hand-holds. Keep steps, grab handles, and shoes free of grease, mud, dirt, fuel, ice and snow. Use extra care during inclement weather.

Certain steps may be of a pivoting or folding design. Be certain that such steps are firmly engaged in the weight bearing position before placing full weight on the step. Make sure steps are deployed in the down position before exiting cab. Failure to deploy steps properly can lead to falls and possible injury.

4-1.1 Automatic Steps

Automatic deploying side entry steps fold out and down to provide easy access to the cab. When properly adjusted, these steps will retract into the cab on either the first or second catch of the door. Other steps may also be of a folding or pivoting design.

4-1.2 Service Areas

This vehicle is designed with areas to access equipment for maintenance or service. These areas may or may not allow three points of contact at all times.

If it is necessary to climb onto, into, or around parts of the vehicle that are not equipped for three points of contact, use an overhead safety harness, step ladder, access platform, or other means to keep safe while working on the vehicle.

4-1.3 High Locations

⚠ WARNING

Fall Hazard - Railings NOT provided

Surface may be slippery - NOT intended for stepping, standing or walking.

Fall will injure or kill.

This vehicle may have a way to access high areas of the truck such as the roof. Use extreme caution when walking on these areas of the vehicle. If railings are not present, then these areas should only be accessed for service or repair in controlled service environments.

GENERAL

Secure the vehicle in a safe, dry location before working on the vehicle. Use an overhead safety harness, fall arrest harness, step ladder, access platform, personal protective equipment, or other means to keep safe while working on the vehicle. If there is no slip resistant surface, use rubber matting or other means to provide traction before attempting to step, stand, or walk on these areas.

4-1.4 No-Step Surfaces

⚠ WARNING

Fall Hazard - Railings NOT provided
Surface may be slippery - NOT intended for stepping, standing or walking.
Fall will injure or kill.

Slip resistant surfaces are present where operators will normally need to step, stand, or walk on the vehicle. Use caution on surfaces that do NOT have slip resistant surfaces and/or do not have railings. These areas are not intended for standing or walking during normal operation.

- If you must step, stand, or walk on these surfaces, use rubber matting or other ways to provide traction on the surface.

4-1.5 Do Not Occupy With Vehicle in Motion

⚠ WARNING

Crash Hazard.
Do not occupy with vehicle in motion.
Failure to comply may result in injury or death.

This vehicle may have an area that is meant to be occupied with the vehicle in a stationary condition only. This restriction may be due to the fact that there are no seats equipped with seat belts. Other reasons for restriction may be that there are un-mounted seats or other equipment that could come loose during a crash. Do not place the vehicle in motion with any person occupying this area.

4-2. Keyless Entry (*Optional*)

4-2.1 To Unlock Officer's Door

- Enter access code
- Listen for double beep
- Within three seconds, press the (1/2) button

4-2.2 To Unlock All Doors

- Enter access code
- Listen for double beep
- Within three seconds, press the (3/4) button

4-2.3 Locking the Doors with Keypad

Press and hold down the (1/2) button for 1-2 seconds.

4-2.4 Additional Information

The dome light illuminates for 20 seconds whenever the system is unlocked from keypad or fob transmitter.

After repeated attempts to enter incorrect codes (20 button presses without enabling), the keypad enters an inactive mode that disables button for 1 minute. This helps prevent undesired access by entering random codes. No beep will sound when pressing buttons while the system is disabled.

See the Pierce Service Manual, group 0810-V-001, TriMark e-ASK Keyless-entry System, for additional information on the keyless entry system (programming fob transmitters, changing authority and access codes, etc.).

Seats, Seat Belts, and Safety Restraints

4-3. Safety Restraints and Devices

4-3.1 Seat Belts

The ultimate mission of any emergency response vehicle is to safeguard the health and welfare of the people they are meant to protect. This mission fails if the emergency responders themselves do not arrive safely. It is therefore essential that the emergency response vehicle is driven in a safe manner, and that all occupants are seated and belted while the vehicle is in motion. During emergency responses, personnel may be inclined to take more risks than usual and to skip basic vehicle safety precautions. Resist this inclination. If a vehicle is in a crash, anyone who is unbelted becomes a hazard to anyone else in the vehicle. An unbelted occupant will become a lethal projectile with the potential to injure or kill those around them.

⚠ WARNING

Never ride in or on this vehicle unless properly restrained in a seating position with a seat belt.

Before fastening seat belts, adjust the seat to a position that maintains adequate head clearance (see suspension style seats) to reduce the risk of head or spinal injury when driving over severe dips or bumps in the pavement.

Always ride with your seat back upright and the lap belt snug and low about your hips to reduce the risk of serious injury to the abdomen or neck that could be caused by sliding under the safety belts in a collision.

Fasten seat belt low and snug on the hips, and the shoulder belt snug against the chest.

Never use a single belt for more than one person or across more than one seating position.

Use the shoulder belt on the outside shoulder only. Never wear the shoulder belt under the arm or swing it around the neck over the inside shoulder.

The effectiveness of an air bag may be reduced on vehicles equipped with an extended front bumper. Always wear seat belts.

The use of seat belts help to restrain you and your passengers in case of a collision. In most states, the law requires their use.

Safety belts provide the best restraint when:

- The seat back is upright.
- The occupant is sitting upright (not slouched).
- The lap belt is snug and low on the hips.
- The shoulder belt is snug against the chest.
- The knees are straight forward.

⚠ CAUTION

Failure to use care in closing the door can cause seat belt damage if the seat belt is caught in the door latch and striker.

In certain cab/body configurations, the seat belt retractor may not retract the belt quickly or completely enough to prevent it being caught in the door. In these instances it is necessary for the belt to be placed manually inside the door before it is closed.

4-3.2 Seat Belt Monitoring System

Most Pierce apparatus are equipped with a Seat Belt Monitoring System (SBMS). The SBMS is capable of monitoring up to ten (10) sensors indicating the status of each seating position in the cab with green and red LED indicators as follows:

- Green - Seat occupied and seat belt buckled
- Red - Seat occupied and seat belt unbuckled
- Red - No occupant in seat and seat belt buckled
- Not Illuminated - No occupant in seat and seat belt unbuckled

The SBMS will include an audible alarm that will be activated when a red illumination condition exists and the parking brake is released, or a red illumination condition exists and the transmission is not in **N** (Neutral).

4-3.3 Side Roll Protection System (*Optional*)

4-3.3a General Description

IMPORTANT: The Side Roll Protection System is only designed to activate during a vehicle side roll accident or whenever the front air bags are deployed. It will not activate during:

- Side impacts;
- Rear impacts;
- End-over-end accidents;
- Other accidents not involving a side roll.

The Side Roll Protection System is a Supplemental Restraint System (SRS) consisting of pyrotechnically actuated advanced protective devices, working in conjunction with the seats and seat belts of the vehicle, to provide the occupant a lower probability for injury during a side roll (up to 90° from vertical). A roll sensor triggers the system. The roll sensor analyzes the vehicle roll angle and rate of roll to determine when the Side Roll Protection System will activate.

4-3.3b General Warnings and Cautions

▲ WARNING

The Side Roll Protection System will only enhance safety if the seat belt is worn! **ALWAYS WEAR YOUR SEAT BELT.** The seat belt will pretension and restrain the occupant during a vehicle side roll accident. If the seat belt is not worn, the occupant will move out of position and become unprotected. The driver's seat pull down system and side air bags are ineffective unless the occupant wears the seat belt.

Children 12 years old and under should be seat belted in a back seat. Never install a child seat in the front seat. Pregnant women should consult their doctor concerning the proper use and positioning of seat belts. Death or serious injury can occur.

Occupants 5 feet $\frac{1}{4}$ inch tall or less, weighing less than 107.5 lbs, or having a sitting height of 31.3 inches or less, must ride in the crew cab seating area. Death or serious injury can occur.

The Side Roll Protection System is a dynamic system that contains pyrotechnic devices that can be dangerous if modified or removed. When activated in a side roll accident, they will exhaust harmless blue smoke. **Never** service, attempt to salvage, or reuse Side Roll Protection System components. **Never** weld or apply heat on or near Side Roll Protection System components. **Never** grind, puncture, or drill on Side Roll Protection System components.

The Side Roll Protection System will decrease the occupant's probability for injury when used properly. In the event of a vehicle side roll accident, the system will activate and there will be rapidly moving components. Keep hands and other objects away from air bags, seat belt buckles, and suspension seat components.

Information on all component caution and warning labels must be complied with. Labels are placed in visible locations on each component of the Side Roll Protection System. If labels have been removed or are not visible, please contact your Pierce Dealer for the proper replacement labels.

CAUTION

Keep hands and other objects out of deployment path of side air bags, suspension seat, and seat belt buckles. Such objects could prevent the air bag from inflating properly or cause injury or death to the occupant when the devices activate.

4-3.3c Side Roll Protection System Components

The system is composed of the following major components: Roll Sensor, Suspension Seat Safety System (S4S), Integrated Gas Pretensioner (IGP) or Integrated Belt Pretensioner (IBP), and Inflatable Head Cushion (IHC) or Supplemental Restraint Air Bag (SRA) (*optional*).

Roll Sensor

Figure 4-1: Roll Sensor



1415

WARNING

The roll sensor triggers air bags and seat restraints. Accidental deployment can cause serious injury.

- Service the roll sensor(s) only if you are an authorized technician.
- Never remove the roll sensor. Removing the roll sensor will turn OFF and/or trigger deployment of the air bags and seat restraints.
- BEFORE welding, disconnect the roll sensor and refer to *“Welding Instructions”* on [page 6-40](#), for additional welding information.
- BEFORE disconnecting the roll sensor, remove the electric power.

The roll sensor monitors the vehicle’s angle and rate of roll. Cabs may be equipped with a single roll sensor or a master roll sensor and a slave. In the event of a side roll accident, the roll sensor sends a signal to deploy the advanced occupant protection devices. The roll sensor stores in memory a ten-second stream of roll angle and rate data that can be retrieved in the event of an incident.

Suspension Seat Safety System (S4S)

Figure 4-2: Suspension Seat Safety System (S4S)

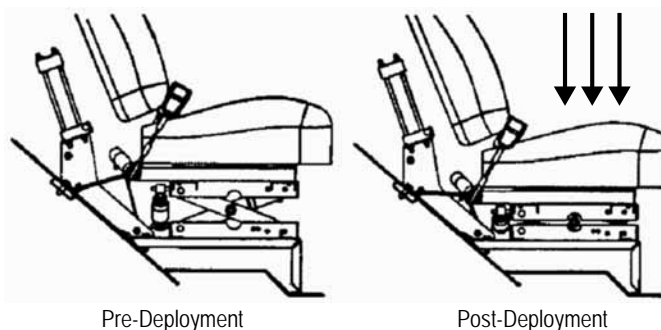

POM0100

WARNING

Keep hands and other objects clear of the deployment path of seat, seat belt, and suspension components.

The S4S actuator is located immediately behind the driver's suspension seat. In the event of a side roll accident the S4S unit deploys, pretensioning the seat belt and pulling the seat to its lowest position. The S4S is only effective when you wear your seat belt. **ALWAYS WEAR YOUR SEAT BELT.**

Integrated Gas Pretensioner (IGP) / Integrated Belt Pretensioner (IBP)

Figure 4-3: Integrated Gas Pretensioner (IGP) / Integrated Belt Pretensioner (IBP)

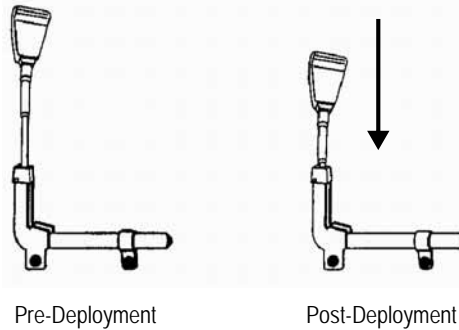

POM0119

CAUTION

Keep hands and other objects clear of the retraction path of the seat belt buckle.

Seat belt pretensioner actuators are located at the base of the seat belt buckle cable in the first officer and crew cab seating positions. In the event of a side roll accident, the IGP/IBP deploys at each non-suspension seat location. The cable pretensioner retracts the cable and buckle assembly, removing up to five inches (120 mm) of slack from the belt. The buckle pretensioner is only effective when you wear your seat belt. **ALWAYS WEAR YOUR SEAT BELT.**

Inflatable Head Curtain (IHC)/Supplemental Restraint Air Bag (SRA)

Figure 4-4: Inflatable Head Curtain (IHC)/Supplemental Restraint Air Bag (SRA)



Mounted to seat back



Integral to seat bolster

POM0122/1109

WARNING

Do not sit or lean unnecessarily close to the air curtain. Do not place or mount any object over the air curtain or between the air curtain and the occupants.

Inflatable Head Curtains (IHC) / Supplemental Restraint Airbags (SRA) are mounted on the seat backs of the outboard rear seats or integral to the outboard seat bolster on PS6™ seats. In the event of a side roll accident, the IHC/SRA inflates the curtain air bag to protect the head and neck from contact with the cab structure. The IHC/SRA is designed to work in conjunction with your seat belts. **ALWAYS WEAR YOUR SEAT BELT.**

4-3.3d What to Expect During the Deployment of the Side Roll Protection System

During a side roll accident, the roll sensor will send a signal to deploy the advanced occupant protection devices to restrain and protect the occupants. Below is a list of what to expect at each seating position during deployment.

Driver Position

The driver position is equipped with a Suspension Seat Safety System (S4S) or Supplemental Restraint Airbags (SRA). The S4S device will quickly activate and pull the seat belt tightly around the occupant. The side air bag will deploy and position itself next to the driver's head. Simultaneously, the seat will be pulled toward the floor and tightly held down until after the vehicle has rolled and stopped. All this will occur in a fraction of a second.

First Officer Position

The first officer position is equipped with Integrated Gas Pretensioner (IGP) / Integrated Belt Pretensioner (IBP) or Supplemental Restraint Airbags (SRA). The IGP will activate and pull the belt snugly around the occupant. The side air bag will deploy and position itself next to the occupant's head. All this will occur in a fraction of a second. The buckle pretensioner will expel some **blue smoke** during deployment. The smoke will have an acrid smell, but will not be harmful.

Rear Occupants

The rear occupant positions are equipped with Integrated Gas Pretensioners (IGP) / Integrated Belt Pretensioners (IBP) and optional Inflatable Head Cushions (IHC) or Supplemental Restraint Airbags (SRA) located outboard of the outside seating positions. The IGP/IBP will activate and pull the belt snugly around the occupant. All this will occur in a fraction of a second. The buckle pretensioner will expel some **blue smoke** during deployment. The smoke will have an acrid smell, but will not be harmful. The IHC/SRA will inflate to protect the head and neck from contact with the cab structure.

4-3.3e What to Do After a Deployment

Vehicle Accident Response Information

⚠ WARNING

The roll sensor is located in either the vehicle headliner or on a structural plate below the gauge cluster. Disturbing this area, changing the position of the vehicle, or the position of the roll sensor within the vehicle, may cause the protective devices to fire. **ALWAYS** deactivate the side roll protection system when performing an extrication if unfired protective devices are present.

Protective device actuators have cylinders containing high-pressure gases and/or pyrotechnics. Hot, pressurized gases are present in cylinders even after they have fired. These cylinders should not be cut or punctured under any circumstances.

In case it is necessary to perform the extrication of an occupant of this vehicle, performing any one of the following will disable the roll sensor and any unfired protective devices:

- Turn battery master switch to the OFF position, **OR**
- Move ignition switch to the OFF position, **OR**
- Disconnect the batteries, **OR**
- Cut the wires to the protective device actuators.

Fired protective devices pose no toxic threat to rescue personnel. After a side roll accident, the seat belts on all the occupants will be tight, but have specially designed buckles that can be released under belt tension. Use extreme care when releasing seat belt buckles and exiting a damaged vehicle. The bags will be filled with warm inert gases. The gases will be nearly invisible, but will have an acrid smell. The gases pose no harm to occupants or rescue personnel.

Pierce Customer Service must be notified whenever the Side Roll Protection System has been activated. **DO NOT** remove or tamper with any Side Roll Protection System components, except to extricate the occupants.

Returning to Service

⚠ WARNING

Do not attempt to remove any Side Roll Protection System components. Any component that did not completely deploy requires special precautions. Contact Pierce Manufacturing for disposal instructions for system components.

After the system is activated, the major components of the Side Roll Protection System will be deployed and cannot be reused. The Suspension Seat Safety System (S4S), roll & slave sensor(s), Integrated Gas Pretensioners (IGP) / Integrated Belt Pretensioners (IBP), and Inflatable Head Curtains (IHC) / Supplemental Restraint Airbags (SRA) must be replaced. In addition, the wiring harnesses will require inspection and possible replacement. After all system components are inspected and/or replaced, the integrity of the system must be checked by a Pierce authorized technician. **This service must be performed by Pierce Manufacturing or a Pierce authorized service facility.**

4-3.4 Frontal Impact Protection (*Optional*)

The cab may be equipped with a frontal impact protection system consisting of an air bag in front of the driver, a knee bolster air bag in front of the first officer seating position, and suspension seat safety system (S4S) for suspension seats or belt pretensioners for fixed seats in the driver or forward first officer positions.

The driver side air bag is mounted in the steering wheel and is designed to protect the head and upper torso of the occupant, when used in combination with the seat belt, in the event of a frontal or oblique impact.

The first officer side knee bolster is mounted in the modesty panel below the dash panel and is designed to protect the legs of the occupant, when used in combination with the seat belt, in the event of a frontal or oblique impact.

▲ WARNING

The knee bolster air bag deploys with great force in the event of a crash. Do not place people or objects in the path of the bag. Objects flying from the bag deployment can injure or kill.

In the event of a frontal impact, the system will deploy the driver air bag and first officer knee bolster and activate the following components that are integrated into the driver and first officer cab seats:

- Suspension safety seat system (S4S) will retract the suspension seat to its lowest travel position;
- Belt pretensioners will pretension the seat belts to firmly hold the occupants in place;
- Side Roll Protection air bags (if the truck has this option.)

4-3.5 SCBA Brackets Mounted in Seat Backs

▲ WARNING

Avoid storing SCBA bottles in seat backs of seats that will not be occupied while the vehicle is in motion. SCBA bottles not secured properly in unoccupied seats could cause serious injury or death during a collision. (Does not pertain to inertia-activated hands-free SCBA holders.)

Always verify that the seat belt buckle and SCBA harness buckle are in their respective proper receptacle. Interchange between the SCBA harness and seat belt buckles will negate the benefit of the seat belt and death or serious injury may result.

Self Contained Breathing Apparatus (SCBA) bottle brackets are designed to hold the SCBA bottle in position while the firefighter is riding to the fire scene. Bottles mounted in seats without occupants must be fastened using the SCBA mounting bracket manufacturer's restraining device. *(Does not pertain to inertia-activated hands-free SCBA holders.)*

SCBA harnesses are often manufactured using nylon straps and buckles similar in construction to seat belt buckles. Care must be taken to ensure that the occupant does not mistake the SCBA harness buckle for the seat belt buckle. We strongly recommend that fire companies check all SCBA harnesses to ensure that they are not interchangeable with the seat belt buckles and that all firefighters are trained to become aware of this danger.

⚠ WARNING

Never operate the vehicle with passengers occupying seats equipped with SCBA brackets without either the SCBA bottles in place or approved back inserts installed to reduce the risk of back injury caused by contact with protruding parts of the SCBA bracket during a collision.

Movable headrests must be placed in the closed position while the vehicle is in motion to reduce the risk of head injury during a collision.

Always leave the SCBA harness loose when riding in the seat. Tight SCBA straps will add the weight of the occupant to the bottle and will pull the bottle out of the holder in the event of a crash. The bottle restraining devices are designed for the weight of the bottle only. SCBA bottles that are not secured properly can injure or kill in the event of a crash.

Seats equipped with SCBA brackets may be used by occupants without SCBA bottles by installing the seat back inserts.

Many SCBA bracket equipped seats include movable headrests that allow the SCBA bottle to be removed without interference with the headrest.

Refer to the SCBA manufacturer's operation manual for proper use instructions.

4-3.6 Seat Adjustment

⚠ WARNING

Certain suspension style seats must be adjusted individually for each occupant to maintain adequate head clearance while the vehicle is in motion, or death or serious injury may result.

Do not adjust driver's seat while vehicle is moving. The seat could suddenly or unexpectedly move causing the driver to lose control of the vehicle.

Operating this vehicle over rough roads or surfaces can result in personal injury. Use caution and reduce speed. Properly adjusted seats and seating systems may not compensate completely for severe road conditions.

Several suspension style seat options are offered for the front seating positions of Pierce fire apparatus. Suspension seats improve comfort by absorbing road deflections and vibrations. The motion of the seat suspension reduces the available head clearance.

For suspension type seat adjustment, refer to the seat operator's manual or to the decal attached to seat frame as supplied by the seat manufacturer.

4-3.7 Adjustable Foot Pedals (*Optional*)

After adjusting the seat, use the pedal adjustment switch to move the throttle and brake pedals to a comfortable position. The pedals offer three inches of adjustment.

Controls, Indicators, and Features

4-4. Heating, Ventilation, Air Conditioning (HVAC)

Figure 4-5: HVAC Control Panel



! DEPENDING ON CONFIGURATION YOUR VEHICLE MAY BE EQUIPPED WITH EITHER TYPE OF CONTROL UNIT



1194, DC0069

4-4.1 Defroster

IMPORTANT: As the defrost and heat are recirculation-only systems, the A/C may be required to dry the air in situations where the windshield might fog over.

This is heat-only, recirculation-only, in-dash unit. Air intake is through the dash panel. Air outlets are contained in a fixed panel for maximum defrost performance. Defrost controls consist of temperature and fan speed.

4-4.2 Heater

There are two heater units, one under each rear-facing seat. Each unit has an outlet at the floor, blowing rearward, and an inlet immediately above in the seat riser. In addition, each unit has a duct routed to the first officer and driver foot area. These outlets are located at floor level directly beneath each seat riser. Controls consist of temperature and fan speed. The left and right units are controlled simultaneously.

4-4.3 Air Conditioning

The air conditioning system is completely external and consists of two boxes, each containing an evaporator and a condenser. Each unit has an air intake located in the headliner just behind the driver and first officer seats. The air is routed to the crew-cab through a headliner plenum and exits through three adjustable ball-style louvers per side. The driver and first officer each have two adjustable ball-style louvers as well. Controls consist of fan speed and an on/off switch. The left and right units are wired through the single control. The ball-style louvers used allow for shutoff or complete directional control of the airflow – these are operator adjustable.

4-5. Hose and Hose Reels

⚠ WARNING

Entanglement Hazard.

Secure hose and other equipment before placing vehicle in motion.

Loose hose may drag behind vehicle and injure or kill.

⚠ CAUTION

When you use the hose, be careful not to wrap it around your leg or against other items. A hose that becomes tangled on something is tripping hazard and can cause damage.

Keep pets and children away from any hose that is being reeled in to prevent accidental strangulation.

1. Straighten the hose until the entire length is as straight as possible, untangling it as you continue along its length.
2. Use a free hand to push the hose all the way over to either the left or the right side of the reel and then begin retracting.
3. Turn the reel one full turn and guide the hose so you create the first layer of hose onto the entire surface of the reel. If you started by pushing the hose all the way to the left, guide the hose toward the right while keeping the hose windings in contact with the previous winding. Your first layer of hose should appear as a horizontal coil going from one side to the other. This forms your first layer of hose.
4. Continue retracting once the hose has been coiled from one side of the reel to the other, but reverse the direction in which you are guiding the hose, making it coil in a second layer, moving toward the side from which you began. You will now have two layered coils of hose on the reel.
5. Continue guiding the hose onto the reel, guiding in a left-right, right-left alternating pattern until the entire length of the hose has been stowed onto the reel.

4-6. Instrument Panel Controls & Indicators

The exact layout of gauges, switches, indicators, and controls on Pierce Custom Chassis varies between models. Instrumentation layouts between vehicles of the same model will vary depending on the level of customization. The following layouts of controls and indicators are the most common. The layout in your Pierce Custom Chassis may vary. Refer to the Instrument Panel Layout drawings, found in the Electrical System Manual, for more information.

4-6.1 Typical Arrow XT™ Instrument Panel

Figure 4-6: Arrow XT™ Driver Side Controls and Indicators (with Command Zone™)

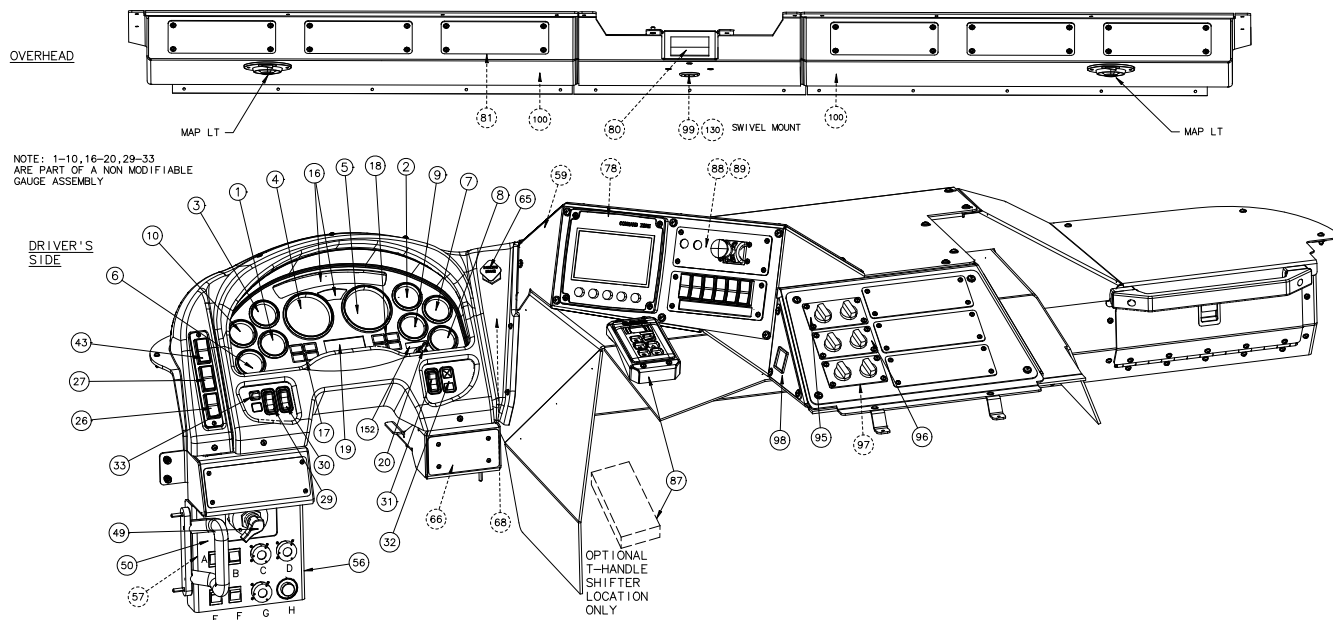

1398

Item #	Description	Item #	Description
1.	Engine Oil Pressure Gauge	C.	Outside Air Temperature
2.	Voltmeter	D.	PTO A Hours
3.	Engine Coolant Temperature Gauge	E.	PTO B Hours
4.	Tachometer	F.	Engine Hours
5.	Speedometer	20.	LCD Multi-function Control
6.	Transmission Oil Temperature Gauge	26.	Ignition Switch/Indicator
7.	Front Air Pressure Gauge	27.	Start Switch
8.	Rear Air Pressure Gauge	29.	Headlight/Parklight Switch
9.	Fuel Gauge	30.	Dimmer Control
10.	Diesel Exhaust Fluid Gauge	31.	High Idle Switch/Indicator
16.	Multiplex Indicator Lights	32.	OK to High Idle Indicator
A.	Left Directional	33.	Emergency Master Button/Indicator
B.	Right Directional	49.	Battery Switch
C.	High Beam Indicator	50.	Diagnostics Panel
D.	Low Coolant	A.	DPF Regeneration Inhibit Switch/Indicator
E.	Check Engine	B.	ABS Diagnostics Switch/Indicator
F.	Auxiliary Brake Overheat	C.	Engine/ABS Diagnostics Port
G.	Caution	D.	Roll Sensor Diagnostics Port
H.	Warning	E.	DPF Regeneration Switch
I.	Parking Brake Applied	F.	Engine Diagnostics Switch/Indicator
J.	Stop Engine	G.	SRS or Frontal/Transmission Diagnostics Port
K.	DPF Regeneration	H.	Command Zone Diagnostics Port
L.	ABS Trailer Fault	56.	Alarm 1
M.	Grid Heater Wait to Start	57.	Alarm 2
N.	Traction Control	59.	Camera Speaker
O.	Check Transmission	65.	Parking Brake
P.	Air Restriction	66.	Interaxle Differential Lock/Indicator

Item #	Description	Item #	Description
	Q. Water in Fuel	68.	Tiller Jackknife Warning Light
	R. Fasten Seat Belts	78.	Command Zone System Display
	S. Rack Down	80.	Seat Belt Monitoring System Display
	T. Engine High Exhaust Temperature	81.	PUC System Display Panel
	U. ABS Traction Fault	87.	Shift Selector
	V. Emission System Malfunction	88.	Air Shift Pump Control
17.	Left Hardwired Indicator Bank	89.	PUC Pump Control
	A. Side Roll Fault	95.	Defroster Controls
	B. Frontal Air Bag Fault	96.	Heater Controls
	C. Battery System On	97.	Air Conditioning Controls
	D. SRS Fault	98.	Mirror Remote
18.	Right Hardwired Indicator Bank	99.	Electronic Siren
	A. Low Diesel Exhaust Fluid	100.	Window Defrost Fan
19.	LCD Display	102.	Customer Supplied Radio
	A. Odometer	152.	Ultra Low Sulfur Diesel Label
	B. Trip Odometer		

Figure 4-7: Arrow XT™ Controls and Indicators (with Command Zone™) (Continued)

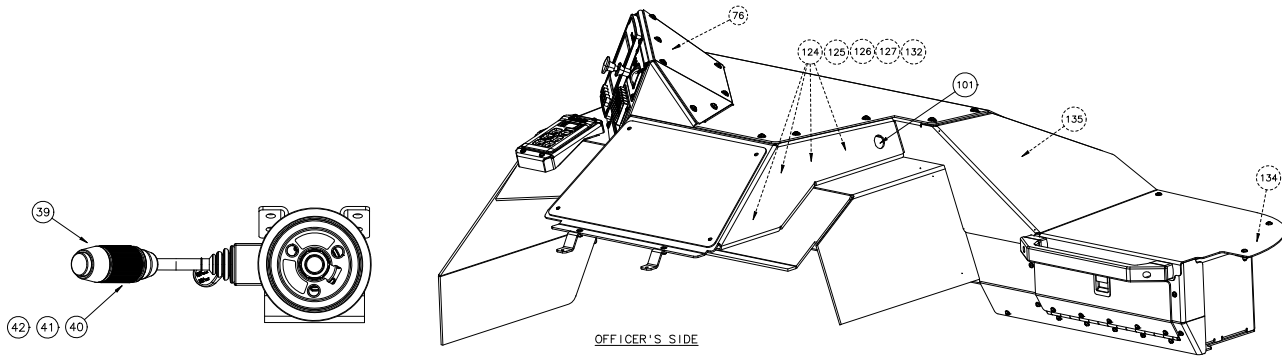

1399

Item #	Description	Item #	Description
76.	Camera Display	127.	Mechanical Siren Pushbutton
101.	Vehicle Data Recorder Port	132.	Power Point
124.	Siren Brake Pushbutton	134.	Map Light
125.	Electronic Siren Pushbutton	135.	Handheld Spotlight
126.	Airhorn Pushbutton		

Figure 4-8: Arrow XT™ Driver Side Controls and Indicators (without Command Zone™)

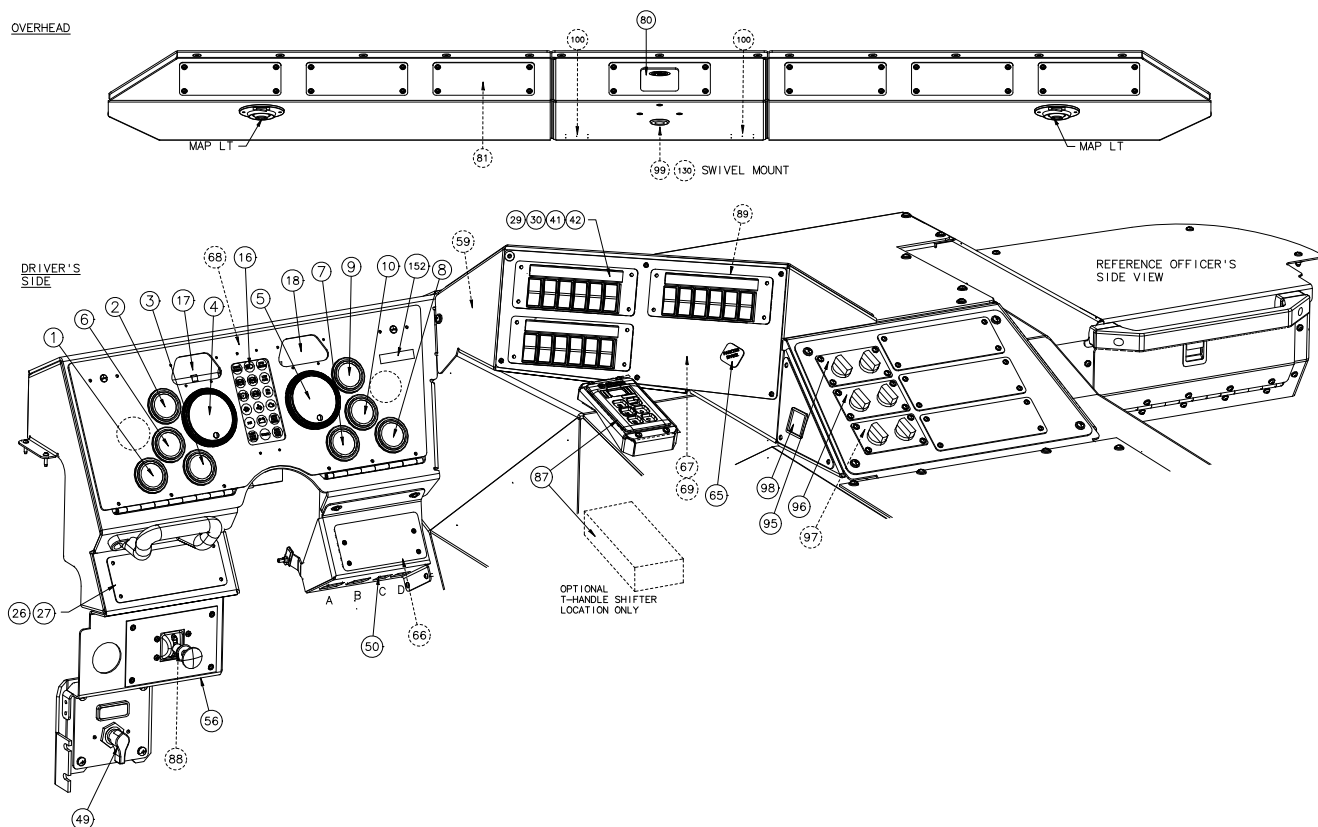

1396

Item #	Description	Item #	Description
1.	Engine Oil PSI Gauge	18.	Right Hardwired Indicator Bank
2.	Voltmeter	A.	Low Diesel Exhaust fluid Level
3.	Engine Coolant Temperature Gauge	26.	Ignition Switch/Indicator
4.	Tachometer w/Engine Hour Meter	27.	Start Switch
5.	Speedometer	29.	Headlight/Parklight Switch
6.	Transmission Oil Temperature Gauge	30.	Dimmer Control
7.	Front Air Pressure Gauge	41.	Wiper/Washer Control Switch, Driver Side
8.	Rear Air Pressure Gauge	42.	Wiper/Washer Control Switch, Officer Side
9.	Fuel Gauge	49.	Battery Switch
10.	Diesel Exhaust Fluid Level Gauge	50.	Diagnostics Panel
16.	Multiplex Indicator Lights	A.	DPF Regeneration Inhibit Switch/Indicator
A.	Left Directional	B.	ABS Diagnostics Switch/Indicator
B.	Right Directional	C.	Engine/ABS Diagnostics Port
C.	High Beam Indicator	D.	Roll Sensor Diagnostics Port
D.	Low Coolant	56.	Alarm
E.	Check Engine	65.	Parking Brake
F.	Auxiliary Brake Overheat	66.	Interaxle Differential Lock/Indicator
G.	Caution	67.	Emergency Shutdown
H.	Warning	69.	Vernier Throttle
I.	Parking Brake Applied	76.	Camera Display
J.	Stop Engine	80.	Seat Belt Monitoring System Display
K.	DPF Regeneration	81.	PUC Display Panel
L.	ABS Trailer Fault	A.	Digital Pump Pressure
M.	Grid Heater - Wait to Start	B.	Water Tank Level

Item #	Description	Item #	Description
N.	Traction Control	C.	Foam Level A
O.	Check Transmission	D.	Foam Level B
P.	Air Restriction	87.	Shift Selector
Q.	Water in Fuel	88.	Air Shift Pump Control
R.	Fasten Seat Belts	89.	PUC Pump Control
S.	Rack Down	95.	Defroster Controls
T.	Engine High Exhaust Temperature	96.	Heater Controls
U.	ABS Tractor Fault	97.	Air Conditioning Controls
V.	Emission System Malfunction	98.	Mirror Remote
17.	Left Hardwired Indicator Bank	99.	Electronic Siren
A.	Side Roll Fault	100.	Window Defrost Fans
B.	Frontal Air Bag Fault	130.	AM/FM Radio
C.	Battery System On	152.	Ultra Low Sulfur Diesel Label
D.	SRS Fault		

Figure 4-9: Arrow XT™ Officer Side Controls and Indicators (without Command Zone™) (Continued)

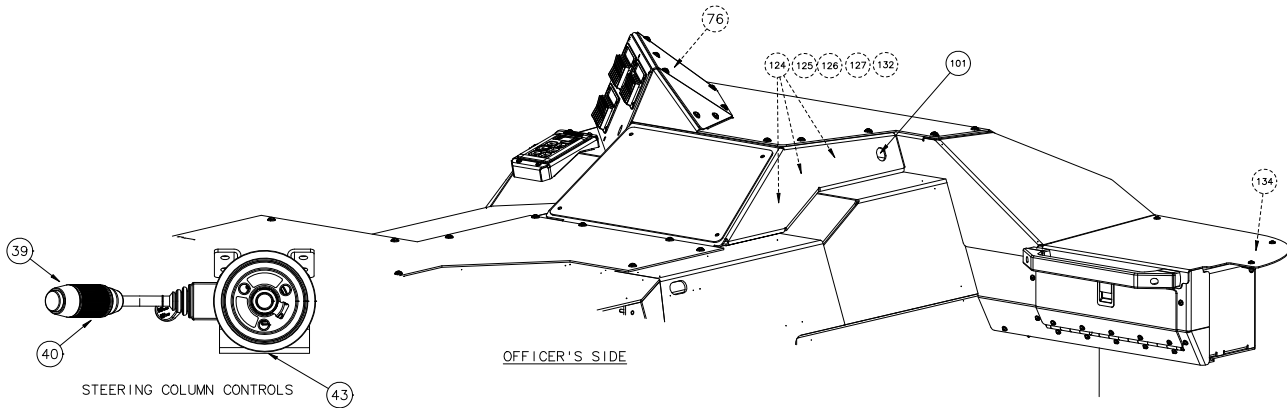

1397

Item #	Description	Item #	Description
39.	Directional Switch	125.	Electronic Siren Pushbutton
40.	Headlight Hi/Lo Beam Switch	126.	Airhorn Pushbutton
43.	4-Way Hazard Switch	127.	Mechanical Siren Pushbutton
76.	Camera Display	132.	Power Point
101.	Vehicle Data Recorder Port	134.	Map Light
124.	Siren Brake Pushbutton		

4-6.2 Typical Arrow XT™ Right Hand Steer Instrument Panel

Figure 4-10: Arrow XT™ Driver Side Controls and Indicators (with Command Zone™)

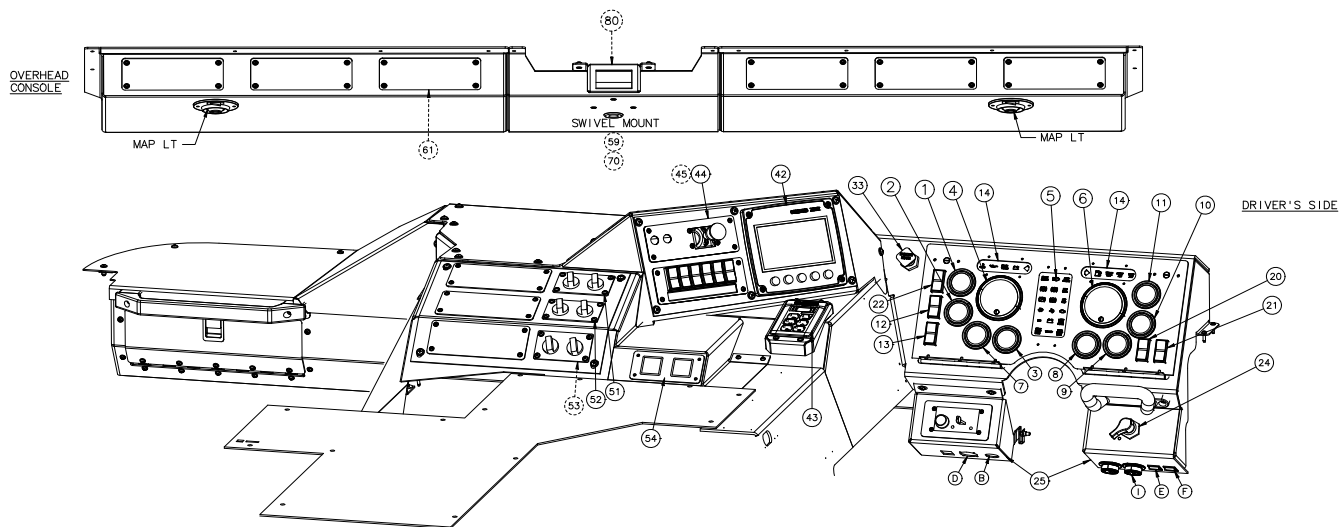

1402

Item #	Description	Item #	Description
1.	Engine Oil Pressure	D.	Low/High Voltage
2.	Voltmeter	E.	Left Directional
3.	Engine Coolant Temperature Gauge	F.	Right Directional
4.	Tachometer	G.	Low Fuel
5.	Center Indicator Module	H.	High Transmission Oil Temperature
A.	Check Engine	I.	Low Front Air Pressure
B.	High Beam Indicator	J.	Low Rear Air Pressure
C.	Stop Engine	20.	Start Switch
D.	ABS	21.	Ignition Switch & Indicator
E.	Traction Control	22.	4-Way Hazard Switch
F.	Low Coolant	24.	Battery Switch
G.	Parking Brake Applied	25.	Diagnostics Panel
H.	Auxiliary Brake Engaged	B.	Command Zone Diagnostics Port
I.	Air Restriction	C.	Engine/ABS Diagnostics Port
J.	Diesel Particulate Filter	E.	ABS Diagnostics Switch & Indicator
K.	High Exhaust System Temperature	F.	Engine Diagnostics Switch & Indicator
L.	Malfuction Indicator	H.	DPF Regeneration Switch
M.	Battery On	33.	Parking Brake
6.	Speedometer	38.	Directional Switch
7.	Transmission Oil Temperature Gauge	39.	Headlight HI/LOW Beam Switch
8.	Front Air Pressure	40.	Wiper Control Switch
9.	Rear Air Pressure	41.	Washer Control Switch
10.	Fuel Gauge	43.	Shift Selector / Indicator
11.	Aerial Hour Meter	51.	Defroster Controls
12.	Panel Dimmer Control	52.	Heater Controls
13.	Headlight/Parklight Switch	57.	Seat Belt Monitoring Display
14.	Top Indicator Module		
A.	High Engine Coolant Temperature		
B.	Low Engine Oil Pressure		
C.	Check Transmission		

Figure 4-11: Arrow XT™ Controls and Indicators (with Command Zone™) (Continued)

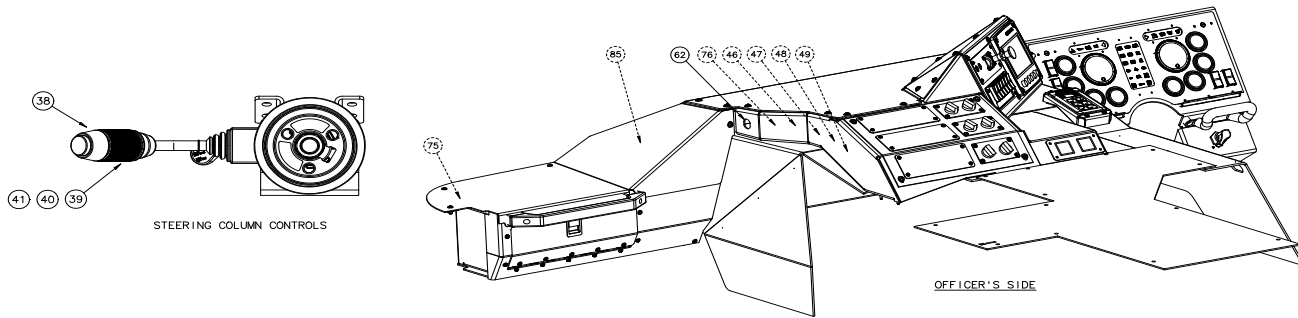

1403

Item #	Description	Item #	Description
38.	Directional Switch	46.	Mechanical Siren Pushbutton
39.	High/Low Beam Switch	48.	Air Horn Siren Pushbutton
40.	Wiper Control	62.	VDR Diagnostics Plug
41.	Washer Control	75.	Map Light
		76.	Power Point
		85.	Handheld Spotlight

4-6.3 Steering Wheel Controls (Optional)

Figure 4-12: Steering Wheel Controls (Optional)

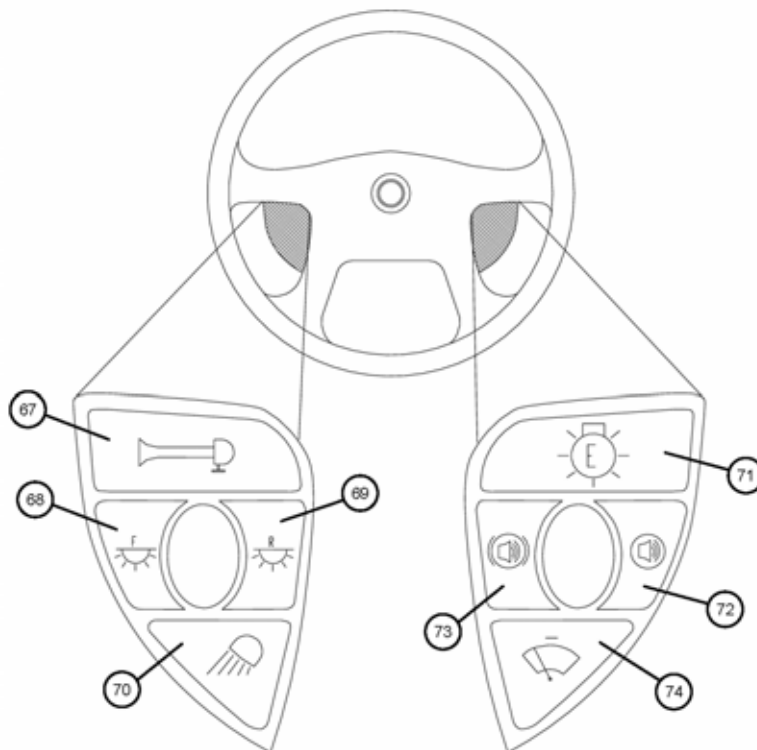

POM0118

Item #	Description	Item #	Description
67.	Air Horn	71.	Emergency Master
68.	Dome Light – Front	72.	Mechanical Siren
69.	Dome Light – Rear	73.	Siren Brake
70.	Area Lighting	74.	Windshield Wipers

4-7. Windshield Wiper System

CAUTION

Windshield wipers should not be run on dry windows for an extended length of time as this will induce higher than normal loads into the system and decrease the life of the motors, linkages, and wiper blades substantially.

The windshield wipers on Arrow XT™, Quantum®, and Saber® have separate motors and switches for the left and right arms.

4-8. Vehicle Data Recorder (VDR)

Most Pierce apparatus are equipped with a Vehicle Data Recorder (VDR). The VDR is capable of reading and storing the most recent 100 hours of vehicle information. The VDR is capable of operating in a voltage range from 8VDC to 16VDC and will continue operation upon termination of power or at voltages below 8VDC for a minimum of 10ms. The VDR will not interfere with, suspend, or delay any communications that may exist on the CAN data link during the power up, initialization, runtime, or power down sequence.

The vehicle data recorder is capable of recording the following data via hard-wired and/or CAN inputs:

- Vehicle Speed - MPH
- Acceleration - MPH/sec
- Deceleration - MPH/sec
- Engine Speed - RPM
- Engine Throttle Position - % of Full Throttle
- ABS Event- On/Off
- Seat Occupied Status - Yes/No by Position (1-6 Seating Capacity)
- Seat Belt Buckled Status - Yes/No by Position (1-6 Seating Capacity)
- Master Optical Warning Device Switch - On/Off
- Time - 24 Hour Time
- Date - Year/Month/Date

Stored VDR data can be downloaded and viewed using a laptop computer and the vendor's vehicle data recorder software; the software is provided with your vehicle on a CD-ROM.

The VDR software contains three different applications. The purpose of each application is explained below:

- VDR Configuration Tool. This application is used to name individual VDR modules, change the password required to access data, and synchronize the clock (if necessary). The ability to name individual VDRs permits customers to give each VDR a unique name. This beneficial for customers whose vehicle fleet contain several vehicles equipped with VDRs.
- VDR Extraction Tool. This application is used to download data from the vehicle's VDR to a laptop computer. Once downloaded, the data is viewed using the Viewer Tool.
- VDR Viewer Tool. This application is used to view and manipulate the downloaded VDR data.

Refer to the vehicle service manual for further information on the VDR system and instructions to use the software.

4-9. Command Zone III

NOTE: Command Zone III is an optional system and may not be present on your vehicle.

Figure 4-13: Information Center Screen Controls



1508

The Pierce Command Zone™ III system is an optional control and monitoring device for your vehicle that works in conjunction with the SAE J1939 data bus. The Command Zone™ system communicates with assigned components of your vehicle to inform the operator of current status of those components. Each vehicle with a Command Zone™ system may be programmed to monitor and/or control different systems on that vehicle.

Command Zone III capabilities include but are not limited to: an optional 7" touchscreen display, data-logging and recording, enhanced diagnostics, prognostics, and troubleshooting capabilities, GPS, and subsystem integration.

Command Zone III is also WiFi capable, acting as its own secure wireless access point for up to five connections.

NOTE: If your vehicle is equipped with Command Zone III, please review "Command Zone III Operation and Maintenance Manual Supplement", PM-C-SU850 for complete details and operating information.



Pre-Trip Inspections

5-1. Pre-Trip Inspection

5-1.1 Reasons for Daily Inspection

To be sure that the vehicle is safe to operate, conduct a pre-trip inspection at the beginning of every work period. Perform a pre-trip inspection to find problems that could cause a crash or breakdown. Although the inspection can be completed by a single individual, it is most effectively accomplished with two. This way one person can be operating interior controls while the second person is checking for exterior functions such as turn signal lamps, flashers, brake lights, etc. Since the performance of a pre-trip inspection as mandated for holders of a Commercial Driver's license would be impractical in emergency response situations, it is important that these inspections occur as part of the daily firehouse routine.

Safety

Safety is the most important and obvious reason for inspecting regularly. Inspecting your vehicle helps you to know your vehicle is safe.

Legal Requirements

Federal and State laws require inspection by the driver. Federal and State inspectors also inspect commercial vehicles. An unsafe vehicle can be put "out of service" until the driver or owner fixes it.

5-1.2 Beginning the Inspection

Perform a pre-trip inspection the same way each time to reduce the probability that something will be missed.

Records Review

Review last vehicle inspection report. Drivers may have to make a vehicle inspection report in writing each day. The vehicle owner should repair any items in the report that affects safety. You should look at the last report to find out what was the matter, if anything. Inspect the vehicle to find out if problems were fixed.

Approaching the Vehicle

Check that the parking brakes are on and/or wheels chocked.

Notice general condition. Look for damage or the vehicle leaning to one side. Look under the vehicle for fresh oil, coolant, grease, or fuel leaks. Check the area around the vehicle for hazards to vehicle movement (people, other vehicles, objects, low hanging wires or limbs, etc.).

5-1.3 Things to Look For During Inspections

	<p>PRE-TRIP AND DAILY VEHICLE INSPECTIONS <small>PERFORM DAILY AT THE BEGINNING OF EVERY WORK PERIOD</small></p>
<p>Things to Look For During Inspections</p>	
<p>Tires</p> <p>Look for tire problems. It is dangerous to drive with bad tires. Look for problems such as:</p> <ul style="list-style-type: none"> • Too much or too little air pressure. • Bad wear. You need at least 4/32 inch tread depth in every major groove on front wheels. You need 2/32 inch on other wheels. No fabric should show through the tread or sidewall. • Cuts or other damage. • Dual tires that come in contact with each other or parts of the vehicle. • Mismatched sizes. • Radial and bias-ply tires used together. • Cut or cracked valve stems. • Re-grooved, recapped, or retreaded tires on the front wheels. 	
<p>Wheels and Rims</p> <p>Bad wheels or rims could cause an accident. A damaged rim can cause the tire to lose pressure or come off. Observe the following warning signs:</p> <ul style="list-style-type: none"> • Rust around wheel nuts may mean the nuts are loose – check tightness. • Missing clamps, spacers, studs, and lugs mean danger. • Mismatched, bent, or cracked lock rings are dangerous. • Wheels or rims that have had welding repairs are not safe. • After a tire has been changed, stop a short while later and recheck tightness of nuts. 	
<p>Brake Drums or Shoes</p> <p>Inspect brakes for the following:</p> <ul style="list-style-type: none"> • Cracked drums or rotors. • Shoes or pads contaminated with oil, grease, or brake fluid. • Shoes or pads worn dangerously thin, missing, or broken. 	
<p>Steering System</p> <p>Inspect the steering system for the following:</p> <ul style="list-style-type: none"> • Missing nuts, bolts, cotter keys, or other parts. • Bent, loose, or broken parts, such as steering column, steering gear box, pitman arm, toe links, or steering shafts. • Check power steering hoses, pump, reservoir, cooler, and fittings for leaks. • Steering wheel play of more than 10 degrees (approximately 2 inches movement at the rim of a 20-inch steering wheel) can make it hard to steer. 	



PRE-TRIP AND DAILY VEHICLE INSPECTIONS

PERFORM DAILY AT THE BEGINNING OF EVERY WORK PERIOD

Things to Look For During Inspections

Suspension System

The suspension system holds up the vehicle and its load. It keeps the axles in place. Broken suspension parts can be extremely dangerous. Check for:

- Spring hangers that allow movement of axle from proper position.
- Cracked or broken spring hangers.
- Missing or broken leaves in any leaf spring. If one fourth or more are missing, it will put the vehicle “out of service,” but any defect could be dangerous.
- Broken leaves in a multi-leaf spring or leaves that have shifted so they might hit a tire or other part.
- Leaking shock absorbers.
- Torque rods or arms, U-bolts, spring hangers, or other axle positioning parts that are cracked, damaged, or missing.
- Air suspension systems that are damaged and/or leaking.
- Any loose, cracked, broken, or missing frame members.
- Broken or damaged torsion bars. Cut or torn tape on torsion bars. (*TAK-4™ suspension only. Refer to Pierce Service Manual, group 0152-P-007, TAK-4™ Torsion Bar Assembly.*)

Exhaust System

A broken exhaust system can let poisonous fumes into the cab. Check for:

- Loose, broken, or missing exhaust pipes, Diesel Particulate Filter (DPF), tailpipes, or vertical stacks.
- Loose, broken, or missing mounting brackets, clamps, bolts, or nuts.
- Exhaust system parts rubbing against fuel system parts, tires, or other moving parts of vehicle.
- Exhaust system parts that are leaking.
- Missing or damaged insulation or heat shields.
- Exhaust temperature mitigation device damage.

Equipment Loading

- Inspect for cargo overloading and correct balance and securement before each trip. If the cargo contains hazardous materials, inspect for proper papers and placarding.

5-1.4 Interior Inspection

	<p>PRE-TRIP AND DAILY VEHICLE INSPECTIONS <small>PERFORM DAILY AT THE BEGINNING OF EVERY WORK PERIOD</small></p>
<p>Interior Inspection</p>	
<p>Cab Interior</p> <p>Lower cab and ensure that the parking brake is set. Put gearshift in neutral and start the engine. Perform the following checks:</p>	
<input type="checkbox"/> No unusual noises.	
<input type="checkbox"/> All gauges indicate within normal operating ranges.	
<input type="checkbox"/> Oil pressure indicates normal within seconds after engine is started.	
<input type="checkbox"/> Voltmeter indicates normal electrical voltage.	
<input type="checkbox"/> Coolant temperature begins a gradual rise to normal operating range.	
<input type="checkbox"/> Review indicator lights to ensure all bulbs are functional.	
<p>Functional Controls</p> <p>Check all of the following for looseness, sticking, damage, or improper setting. Ensure that all are operational.</p>	
<input type="checkbox"/> Steering wheel.	
<input type="checkbox"/> Accelerator.	
<input type="checkbox"/> Brake controls.	
<input type="checkbox"/> Parking brake.	
<input type="checkbox"/> Retarder controls (if so equipped).	
<input type="checkbox"/> Transmission controls.	
<input type="checkbox"/> Interaxle differential lock (if so equipped).	
<input type="checkbox"/> Horn(s).	
<input type="checkbox"/> Windshield wiper/washer.	
<input type="checkbox"/> Lights.	
<input type="checkbox"/> Headlights.	
<input type="checkbox"/> Dimmer switch.	
<input type="checkbox"/> Turn signal.	
<input type="checkbox"/> 4-way flashers.	
<input type="checkbox"/> Clearance, identification, and marker lights.	
<input type="checkbox"/> Tire chains (when winter conditions require them).	
<p>Glass</p> <p>Check mirrors and windshield.</p>	
<input type="checkbox"/> Windshield is free of dirt and ice.	
<input type="checkbox"/> Windshield is free from cracks or distortion.	
<input type="checkbox"/> Mirrors are clean and properly adjusted.	
<p>Safety Equipment</p> <p>Ensure that the vehicle is equipped with the following safety equipment:</p>	
<input type="checkbox"/> Spare electrical fuses (if equipped).	
<input type="checkbox"/> Three red reflective triangles.	
<input type="checkbox"/> Properly charged and rated fire extinguisher.	

5-1.5 Exterior Inspection

Perform a walk around inspection. Re-enter the cab as required during the inspection to check that exterior features are functioning properly.

 PRE-TRIP AND DAILY VEHICLE INSPECTIONS <small>PERFORM DAILY AT THE BEGINNING OF EVERY WORK PERIOD</small>
Exterior Inspection
Engine Compartment
NOTE: Secure loose items in cab and ensure the vehicle is on a flat and level surface before tilting.
Tilt the cab or open the engine compartment doors and check the following:
<input type="checkbox"/> Engine oil level OK.
<input type="checkbox"/> Automatic transmission fluid level and physical appearance OK. (Refer to <i>“Transmission Fluid Analysis”</i> on page 6-29, for additional information.)
<input type="checkbox"/> Coolant level in radiator OK.
<input type="checkbox"/> Power steering fluid level OK.
<input type="checkbox"/> Windshield washer fluid level OK.
<input type="checkbox"/> Hoses show no signs of excessive wear, damage, or leaking.
<input type="checkbox"/> Belts are tight and show no sign of excessive wear. With engine off, press belt to test that it is snug.
<input type="checkbox"/> No apparent leaks of fuel, coolant, oil, power steering fluid, hydraulic fluid, or battery fluid.
<input type="checkbox"/> Electrical wiring insulation shows no sign of excessive wear, chafing, or damage from heat.
Batteries
<input type="checkbox"/> Battery box securely mounted to vehicle.
<input type="checkbox"/> Batteries not broken or leaking.
<input type="checkbox"/> Fluid in batteries at proper level (except maintenance-free type).
<input type="checkbox"/> Cell caps present and securely tightened (except maintenance-free type).
<input type="checkbox"/> Vents in cell caps free of foreign material (except maintenance-free type).
Left Front Side
<input type="checkbox"/> Driver’s door glass should be clean.
<input type="checkbox"/> Door latches and window regulators work properly.
Left Front Wheel
<input type="checkbox"/> Wheel and rim are in good condition – no missing, bent, or broken studs, clamps, or lugs. Show no signs of misalignment.
<input type="checkbox"/> Condition of tires – properly inflated, valve stem and cap OK, no serious cuts, bulges, or excessive tread wear.
<input type="checkbox"/> Use wrench to test – rust streaked lug nuts, indicating looseness.
<input type="checkbox"/> Hub oil level OK. No leaks apparent.
Left Front Suspension
<input type="checkbox"/> Spring, spring hangers, shackles, U-bolts are in good condition.
<input type="checkbox"/> Shock absorber shows no sign of excess wear or damage.
<input type="checkbox"/> Torsion bar is not damaged and tape is not cut or torn. (<i>TAK-4™ suspension only. Refer to Pierce Service Manual, group 0152-P-007, TAK-4™ Torsion Bar Assembly.</i>)
Left Front Brake
<input type="checkbox"/> Brake drums or rotors are not cracked or worn.
<input type="checkbox"/> Hoses show no signs of excessive wear.



PRE-TRIP AND DAILY VEHICLE INSPECTIONS

PERFORM DAILY AT THE BEGINNING OF EVERY WORK PERIOD

Exterior Inspection (continued)

Front of Vehicle

- Front axle shows no signs of damage or excessive wear.
- Steering linkages are tight and show no signs of damage. Grasp each steering link and test for looseness.
- Windshield is clean and shows no sign of cracks or other damage. Perimeter seal is holding windshield glass firmly in place
- Windshield wiper arms have proper spring tension.
- Wiper blades are in good condition.

Front Lights and Reflectors

- Parking, clearance, and identification lights clean, operating, and proper color (amber at front).
- Reflectors clean and proper color (amber at front).
- Turn signal lights clean, operating, and proper color (amber or white on signals facing forward).

Right Front Wheel

- Wheel and rim are in good condition – no missing, bent, or broken studs, clamps, or lugs. Show no signs of misalignment.
- Condition of tires – properly inflated, valve stem and cap OK, no serious cuts, bulges, or excessive tread wear.
- Use wrench to test – rust streaked lug nuts, indicating looseness.
- Hub oil level OK. No leaks apparent.

Right Front Suspension

- Spring, spring hangers, shackles, U-bolts are in good condition.
- Shock absorber shows no sign of excess wear or damage.
- Torsion bar is not damaged and tape is not cut or torn. (TAK-4™ suspension only. Refer to Pierce Service Manual, group 0152-P-007, TAK-4™ Torsion Bar Assembly.)

Right Front Brake

- Brake drums or rotors are not cracked or worn.
- Hoses show no signs of excessive wear.

Right Front Side

- Passenger's door glass should be clean.
- Door latches and window regulators work properly.
- Primary and safety cab locks engaged.
- Rear of engine - not leaking.
- Rear of transmission - not leaking.
- Exhaust system – secure, not leaking, not touching wires, fuel or air lines.
- Frame and cross members – no bends or cracks.
- Air lines and electrical wiring – secured against snagging, rubbing, wearing.

Right Rear Wheel

- Wheel and rim are in good condition – no missing, bent, or broken studs, clamps, or lugs. Show no signs of misalignment.
- Condition of tires – properly inflated, valve stem and cap OK, no serious cuts, bulges, or excessive tread wear.
- Use wrench to test – rust streaked lug nuts, indicating looseness.
- Tires are of the same type - not mixed radial and bias type).
- Tires evenly matched (same sizes).
- Wheel bearing/seals not leaking.



PRE-TRIP AND DAILY VEHICLE INSPECTIONS

PERFORM DAILY AT THE BEGINNING OF EVERY WORK PERIOD

Exterior Inspection (continued)

Right Rear Suspension

- Spring, spring hangers, shackles, U-bolts are in good condition.
- Shock absorber shows no sign of excess wear or damage.
- Powered axle(s) not leaking lube (gear oil).
- Torque rod arms and bushings show no sign of excessive wear.

Right Rear Brake

- Brake drums or rotors are not cracked or worn.
- Hoses show no signs of excessive wear.

Side Lights and Reflectors

- Side-marker lights clean, operating, and proper color (red at rear, others amber).
- Side-marker reflectors clean and proper color (red at rear, others amber).

Rear Lights and Reflectors

- Rear clearance and identification lights clean, operating, and proper color (red at rear).
- Reflectors clean and proper color (red at rear).
- Taillights clean, operating, and proper color (red at rear).
- Rear turn signals operating and proper color (red, yellow, or amber at rear).

Rear of Vehicle

- License plate(s) present, clean, and secured.
- Splash guards present, not damaged, properly fastened, not dragging on ground or rubbing tires.
- Rear doors securely closed, latched/locked.

Left Rear

- Fuel tank is securely mounted, not damaged or leaking.
- Fuel tank contains enough fuel.
- Fuel cap is on and secure.

Left Rear Wheel

- Wheel and rim are in good condition – no missing, bent, or broken studs, clamps, or lugs. Show no signs of misalignment.
- Condition of tires – properly inflated, valve stem and cap OK, no serious cuts, bulges, or excessive tread wear.
- Use wrench to test – rust streaked lug nuts, indicating looseness.
- Tires are of the same type - not mixed radial and bias type).
- Tires evenly matched (same sizes).
- Wheel bearing/seals not leaking.

Left Rear Suspension

- Spring, spring hangers, shackles, U-bolts are in good condition.
- Shock absorber shows no sign of excess wear or damage.
- Powered axle(s) not leaking lube (gear oil).
- Torque rod arms and bushings show no sign of excessive wear.

Left Rear Brake

- Brake drums or rotors are not cracked or worn.
- Hoses show no signs of excessive wear.

5-1.6 Brake Testing

	<p>PRE-TRIP AND DAILY VEHICLE INSPECTIONS <small>PERFORM DAILY AT THE BEGINNING OF EVERY WORK PERIOD</small></p>
<p>Brake Testing</p>	
<p>Secure all loose articles in cab, fasten seat belts, and start the engine. Proceed with functional brake tests as follows:</p>	
<p>Test Parking Brake</p> <ol style="list-style-type: none"> 1. Allow vehicle to move forward slowly. 2. Apply parking brake. <p>If vehicle does not stop, bring it to a stop using the service brakes and have the problem repaired by a qualified truck service facility.</p>	
<p>Test Service Brake Stopping Action</p> <ol style="list-style-type: none"> 1. Accelerate to about five miles per hour. 2. Push brake pedal firmly. <p>Excessive pulling to one side or the other, unusual brake pedal “feel,” or delayed stopping action may indicate a problem. Have the problem diagnosed and repaired by a qualified truck service facility.</p>	
<p>Test Dual Air Brake System Warning Light and Buzzer</p> <p style="padding-left: 40px;">NOTE: If the warning signal doesn’t work, the vehicle could lose air pressure without the knowledge of the operator. This will reduce the effectiveness of the brakes and increase stopping distance. Have the problem diagnosed and repaired by a qualified truck service facility.</p> <p>A dual air brake system has two separate air brake systems that use a single set of brake controls. Each system has its own air tank, hoses, lines, etc. One system typically operates the regular brakes on the rear axle or axles. The other system operates the regular brakes on the front axle. The first system is called the “primary” system. The other is called the “secondary” system.</p> <ol style="list-style-type: none"> 1. Allow time for the air compressor to build up a minimum of 110-psi pressure in both the primary and secondary systems. 2. Shut the engine off when the air pressure rises sufficiently to shut off the low pressure light and buzzer. 3. Shut the ignition switch off and step on and off the brake pedal to reduce air tank pressure. 4. Note the pressure at which the low air pressure warning signal alarm begins. Alarm should signal before the pressure drops to less than 60 psi in the air tank with the lowest air pressure. 	
<p>Test That the Spring Brakes Come On Automatically</p> <p>The parking brakes should engage any time brake pressure drops below 40 psi. Test this function as follows:</p> <ol style="list-style-type: none"> 1. Chock the wheels. 2. Allow air pressure to build sufficiently to release the parking brakes. 3. Step on and off the brake pedal to reduce the air tank pressure. The “parking brake” knob should pop out when the air pressure falls to 40 psi. This will engage the spring brakes and help to prevent the vehicle from moving. 	

**PRE-TRIP AND DAILY VEHICLE INSPECTIONS***PERFORM DAILY AT THE BEGINNING OF EVERY WORK PERIOD***Brake Testing**

Secure all loose articles in cab, fasten seat belts, and start the engine. Proceed with functional brake tests as follows:

Test the Rate of Air Pressure Buildup

Time the rise in pressure from 85 to 100 psi with the engine at operating rpm. Pressure should build from 85 to 100 psi within 45 seconds. (If the vehicle has larger than minimum air tanks, the buildup time can be longer and still be safe.) If air pressure does not build up fast enough, pressure may drop too low during driving, requiring an emergency stop. Do not drive until the problem has been repaired.

Test Air Leakage Rate

1. Run the engine to fully charge the air system to 125 psi.
2. Turn off the engine and release the service brake.
3. Time the air pressure drop. The loss rate should be less than 2 psi in one minute for single vehicles.
4. Apply 90 psi or more with the brake pedal. After the initial pressure drop, the pressure should not fall more than 3 psi in one minute.

If the leakage rate is greater than 3 psi per minute, check for air leaks and fix before driving the vehicle.

Test Air Compressor Governor Cut-In and Cut-Out Pressure

The air compressor should start pumping at about 100 psi and stop at about 125 psi.

1. Operate the engine at a fast idle and monitor the pressure at the gauge.
2. Listen for the air pressure governor to cut out (indicated by a pressure discharge from the air dryer and a halt to the rise of the gauge needle). The air governor should cut out the air compressor at about 125 psi.
3. Operate the engine at idle.
4. Apply and release the brake pedal to reduce the air tank pressure. The compressor should cut in at about 110 psi (indicated by a rise in the pressure at the gauge)

General Operation

5-2. Cab Occupant Capacity

⚠ WARNING

All occupants must be seated and belted when the apparatus is in motion or serious injury or death may result.

Do not ride on the rear step or any other area outside the cab while the vehicle is in motion or death or serious injury may result.

Never transport more people than the seating capacity of the vehicle. Carrying additional personnel may result in death or serious injury.

The number of occupants that can be safely carried is listed on the Federal Motor Vehicle Safety Standard (FMVSS) information decal located inside the cab. Only those seating positions equipped with factory installed seat belts are to be occupied while the vehicle is in motion. Any seat, bench, or stool not equipped with a factory installed seat belt is to be used by emergency personnel only while the vehicle is stationary with the parking brakes properly applied.

5-3. Compartment Doors

⚠ WARNING

NEVER step on open compartment doors.

They do not support your weight.

Falls can cause serious injury or death.

Keep compartment doors closed when not in use.

Personnel in a hurry may tend to leave doors open after retrieving equipment. Always close swing-up or swing-out compartment doors. People can walk into doors left open at lower levels and become injured.

Swing up door should always be shut when not in use. Personnel working on top of the apparatus can mistake an open horizontal door for a walking surface.

5-4. Cab Tilt Operation

⚠ WARNING

Remove all loose items from the cab compartment before tilting as contents may shift or drop causing property damage or personal injury.

Never work around or under a tilted cab unless the stay arm or mechanical support is secured in the support position. Hydraulic cylinders can leak or drift and cannot be relied upon to support the cab on their own. Failure to ensure that the stay arm is securely in its support position could cause severe personal injury or death.

CAUTION

Check front bumper extension to ensure that covers are shut and plumbing swivels are rotated forward before tilting cab to avoid possible interference and subsequent property damage when cab is fully tilted.

Always ensure that the vehicle is on a flat and level surface before tilting the cab. Tilting the cab on an inclined or non-flat surface may produce interference between components as the cab is lowered causing damage to the air intake seal and engine tunnel.

If the cab fails to lower after following the proper instructions, do not attempt to force it. Have the system checked by a qualified mechanic, refer to *“Cab Tilt System”* on [page 6-1](#) in the Maintenance section of this manual, and the Cab section of the Service manual.

Do not operate the air conditioning with the cab up.

The cab should not be raised until the air conditioner has been shut-off and the truck has sat with the battery switch ON for at least 30 minutes. This will allow the water to be pumped out of the air conditioner unit. Failure to do so will result in water condensation dripping out through the openings in the evaporator cover when the cab is lowered after service.

Pierce Custom Chassis may be equipped with one of three types of cab tilt systems.

- The **Type I** system includes a lever-operated hydraulic valve to change the direction of the fluid flow to the lift cylinders in conjunction with a two-position toggle switch (ON-OFF) to operate the electric pump.
- The **Type II** system has two momentary switches (Lock Release & Activate) with a Raise/Lower switch.
- The **Type III** system has a momentary hand-held switch, on a coiled tether, with a Raise/Lower switch.

Every tilt cab has a mechanical means of supporting the cab once it has been tilted. Some models employ a stay arm that must be positioned manually. Other models incorporate a locking channel as part of one of the lift cylinders.

5-4.1 Cab Lift System

WARNING

Always check for people working on or around the cab before raising or lowering the cab. Failure to ensure that everyone is clear of the cab could cause severe personal injury or death.

To Raise Cab

1. Before tilting the cab, ensure that the vehicle is on a flat and level surface, engine is off, transmission is in **N** (Neutral), and the parking brakes are set.
2. Turn on the battery and ignition switches. Set the parking brake.
3. Turn the control switch to RAISE position.
4. Depress the tether switch until the cab is fully tilted.
5. Remove the stay arm from its stowed position and raise it into the stay arm pocket on the engine tunnel.
6. Verify the stay arm is positioned securely in the stay arm pocket before proceeding.
7. Turn the control switch to the LOWER position and depress the tether switch until the top of the stay arm is inside the stay arm pocket and the cab is lightly resting on the stay arm.

To Lower Cab

1. Turn on the battery and ignition switches. Set the parking brake.
2. Turn the control switch to the RAISE position and momentarily activate the tether switch until the cab is fully tilted and the stay arm can be lowered.
3. Lower the stay arm to the stowed position. Verify it is secured or locked in the stowed position.
4. Set the control switch to the LOWER position.
5. Depress and hold the tether switch to lower the cab.
6. Continue to depress the tether switch for at least 5 seconds after the cab comes to rest.
7. Check to ensure the cab is fully seated before operating the vehicle.

5-4.2 Manual Pump Operation (*Optional*)

If the chassis is equipped with a manual pump option, the tilt pump can be operated by hand in the event that power is lost on the vehicle. Locate the pump handle and insert it in the tube at the pump pivot. Use the same procedures as listed above but with the following exceptions:

CAUTION

Do not overtighten the flow control valve. Overtightening could cause the valve not to function properly, and cause the cab not to tilt or lower as desired.

Operate the hand pump in place of moving the toggle switch to the RAISE position. Operate the hand pump rapidly for the first few strokes so that the fluid flows rapidly enough to close the internal system bypass valve.

Locate the small push button at the end of the descent valve solenoid on the hydraulic power unit. Turn this button counterclockwise and pull out in place of moving the toggle switch to the LOWER position. To raise the cab, this button must be pushed in and rotated clockwise.

5-5. Electrical

5-5.1 Alternator

CAUTION

Always observe proper polarity when making connections to the electrical system. Improper connection of batteries, jumper cables, and charging systems can cause damage to the electrical system or to the alternator.

All alternators in Pierce Custom Chassis are of the self-energizing type. Start-up of the alternator is delayed until the engine oil pressure reaches operating levels. This design avoids the situation where the alternator attempts to make up for the heavy battery drain caused by starter operation. This reduces the cranking torque required and protects the voltage regulator from overload. It is therefore normal for the voltmeter to register a lower value for several seconds during and following the starting procedure until the engine oil pressure rises sufficiently to activate the alternator.

5-5.2 Ammeter (*Optional*)

The ammeter displays the amount of current being supplied to the battery by the alternator or the rate of discharge from the battery with the engine running. A slight charge to the battery will be indicated even with the batteries fully charged.

5-5.3 Battery

⚠ WARNING

<p>Batteries give off hydrogen gas that is highly explosive. Exploding batteries will injure or kill. Ventilate area when servicing. Keep all sources of ignition away when working around batteries. Sparks caused by connection of battery terminals, jumper cables, or charging systems can be a source of ignition. Always wear safety goggles and protective clothing when working on or around batteries.</p>
<p>Inhaling of hydrogen gas produced by the normal operation of the battery could result in partial or permanent damage to the respiratory system.</p>
<p>Battery posts, terminals, and related accessories contain lead and lead compounds – chemicals known to cause cancer and reproductive harm. Wash hands after handling.</p>
<p>Whenever disconnecting battery terminals, always disconnect the ground terminal first. When reconnecting, always connect the ground terminal last.</p>
<p>Do not attempt to jump-start a vehicle having a frozen battery, because the battery may rupture or explode. If a frozen battery is suspected, examine all fill vents on the battery. If ice can be seen, do not attempt to start with jumper cables as long as the battery remains frozen. Thaw out battery and recharge.</p>
<p>Do not check battery condition by shorting across terminals.</p>
<p>Failure to observe these instructions could result in property damage, personal injury, or death.</p>

A typical automotive battery contains lead and sulfuric acid. A lead-acid battery charges as current is fed into it by the vehicle alternator, or an external source such as jumper cables. Lead and sulfuric acid react at the anode where lead sulfate is produced, and excess electrons and hydrogen accumulate as a by-product. Sulfuric acid and lead react and release lead oxide and hydrogen gas.

Hydrogen is highly explosive and a mere spark can set it off. Some automotive batteries contain vents to allow the gas to escape, so any ignition source or even a cigarette near the battery may cause an explosion or fire. A battery detonation will likely throw caustic acid into a person's eyes or on their skin.

A battery can get hot to the touch if the starter motor is cranked for a longer than normal period of time. Allowing a battery to become shorted, such as by a metal tool, may cause the battery to rupture and spew toxic acid, or possibly even explode as well.

The standard battery offerings supplied with Pierce Custom Chassis are of a maintenance-free design. To ensure a proper electrical supply, battery terminals must be clean and tight. Use hot water and baking soda for removing corrosion and for cleaning the top of the batteries. Polish the contact surface of the terminals with steel wool and apply a light coat of dielectric lubricant before installing terminals. Ensure that the battery terminals are clamped tightly.

5-5.4 Battery Charging Precautions

- Always disconnect battery leads while charging batteries.
- A fast charger should never be used as a booster for starting the engine.
- Always connect battery charger leads to vehicle battery leads of the same polarity.
- Check ground or return circuit polarity visually (or with a voltmeter) before connecting batteries or other voltage-producing components into the system.

5-5.5 Battery Switch

CAUTION

Never turn the battery switch off while the engine is running or damage to the alternator may result.

The battery switch is used to disconnect electrical power to the vehicle to prevent discharge while the vehicle is not in use.

5-5.6 Voltmeter

The voltmeter measures the voltage across the battery terminals and gives an indication of the electrical condition of the battery. Operating voltage while the alternator is charging may vary between vehicles depending on the regulator setting.

5-5.7 Circuit Breakers and Fuses

WARNING

Wire gauge is designed to meet the fuse/circuit breaker ratings or transistor trip amperages. Do not increase the circuit breaker or fuse size. Improper fuse or circuit breaker sizing can cause wires to overheat and burn, which could cause personal injury or death.

Electrical circuits are protected either by circuit breakers or fuses. Vehicles equipped with Command Zone™ also utilize transistors (solid state logic).

5-5.8 Hourmeter

The hourmeter records the number of hours that the engine has run.

5-5.9 Pyrometer (Optional)

The pyrometer gauge indicates the exhaust gas temperature.

5-5.10 Speedometer and Odometer

The speedometer indicates the vehicle speed. Speed sensing is provided by a signal from the transmission Electronic Control Unit (ECU) and will be affected by changes in rear axle ratio or tire size.

5-5.11 Low Fuel Warning Light

When the level in the fuel tank has dropped to the 1/8th tank mark:

- Light in fuel gauge comes on steady,
- Amber caution light in indicator bank comes on steady,
- LCD display CAUTION text will flash with LOW FUEL LEVEL message.

When the level in the fuel tank has dropped to the 1/32th tank mark:

- Red warning light in indicator bank comes on steady,
- LCD display WARNING text will flash with VERY LOW FUEL LEVEL message,
- Caution alarm will chime.

5-5.12 Tachometer

The tachometer indicates engine speed in revolutions per minute (rpm).

5-5.13 Turn Signal Switch

The turn signal switch located on the left side of the steering column is self-canceling. In addition to operating the turn signals, this switch also operates the high beam headlights, windshield wipers and washers*:

- Turn signals – raise or depress the lever to operate the turn signal lights.
- High beam – low beam switching is accomplished by pulling on the lever until it clicks.
- Headlight flash to pass – pull on the switch lever to flash the headlights with the headlight switch turned off. Pull on the lever gently so that it does not travel to the click position to flash the high beams when the headlights are switched off.
- Windshield wipers – rotate the knob at the end of the lever to activate the wipers (high/low/intermittent).
- Windshield washers – depending on the model, press the knob at the end of the lever, or grasp the collar near the end of the stalk and press inward to activate the washers.

* Arrow XT™/Dash® CF/Impel™/Velocity™ with Command Zone™.

5-5.14 Warning Lights

Warning lights are provided to alert the operator that fluid levels, pressures, or temperatures are outside the normal operating range. These lights may be located together, or next to each corresponding gauge, depending on chassis model. The following warning lights are standard on Pierce Custom Chassis:

- Engine oil pressure
- Transmission oil temperature
- Coolant level
- Air brake pressure – front and rear
- Engine coolant temperature
- Engine air intake restriction
- Voltage level
- Fuel level low

The following apply to vehicles equipped with Command Zone™ only:

- Amber engine warning light (AWL) - check engine
- Red engine stop light (RSL)
- Engine high exhaust temperature (HET)
- Check transmission
- Water in fuel filter
- Auxiliary brake overheating
- Engine diesel particulate filter (DPF) regeneration light
- Engine emissions system malfunction (MIL)
- Air restriction
- Ladder rack down

On multiplexed vehicles, this warning light information is also monitored by the Command Zone™ system. The Command Zone™ system operates some dash indicators and all alarms. Text messages related to most abnormal conditions are displayed on the Command Zone™ Information Center (CZIC) and on the 4-line LCD display on the instrument panel*.

* Vehicles equipped with Command Zone™ only.

5-5.15 Hazard Flashers

A switch located on the left side of the instrument panel actuates the hazard flashers. The hazard flashers will operate with the battery master switch and ignition switch in the ON position.

5-5.16 Starter and Ignition Switches

Pierce Custom Chassis are equipped with an ignition switch and a starter switch. The ignition switch engages operational power to the chassis. The starter switches engage the starter motor for cranking.

5-5.17 Radio Installation

CAUTION

Failure to follow the installation guidelines, even though the equipment may appear to operate satisfactorily, may lead to low voltage problems, radio frequency interference, or poor radio performance.

Vehicles equipped with Command Zone™: Failure to follow the installation guidelines may lead to radio frequency interference, which can affect the operation of multiplex components.

Disconnect all solid-state devices before welding on the vehicle, or equipment damage may result.

Any radio or other electronic equipment should be installed with the utmost care and craftsmanship by qualified personnel only. Refer to the *"Mobile Radio Installation Guide"* on [page A-1](#) before installing radio equipment.

5-6. Fire Scene Operation

5-6.1 High Heat Sources

Direct exposure of the vehicle to extreme high temperatures can cause damage to electrical systems, rubber seals and gaskets, and plastic components. Always operate vehicle a safe distance away from flames or heat source.

5-6.2 Flying Embers

WARNING

To avoid the risk of engine fire leading to property damage, serious injury, or death, do not operate the vehicle in an area where burning embers can be ingested directly into the air intake system.

Diesel engines consume as much as 1200 cubic feet of clean air every minute when operating under full load. Hot embers sucked into the air intake can cause the air cleaner element to ignite. Although Pierce Custom Chassis are equipped with ember barriers composed of mesh screens or perforated metal, they are not a foolproof guarantee of protection.

5-7. Mirrors

Adjust all side view mirrors before operating the vehicle. Check mounting hardware to ensure that mirror heads are secure and will not lose adjustment during operation. Careful side view and rear view mirror adjustment is critical to the safe operation of any vehicle. Always adjust side and rear view mirrors to optimize visibility before setting the vehicle in motion.

Use a partner to walk around the vehicle to identify the blind spots and compensate for this lack of vision while driving by slowing down before making turns or lane changes into blind spot areas where other vehicles may be hidden.

Where multiple drivers share a vehicle, always allow extra time between shifts to ensure that adjustments to mirrors can be made.

5-8. Pump

IMPORTANT: In the event that the throttle control at the pump operator's panel becomes inoperative, the accelerator pedal in the cab may be used as an alternative means to control the engine speed while pumping. (*Detroit Diesel engines only.*)

Some Pierce fire apparatus are equipped with a driveline driven water pump. For pump operating information, refer to the *Pierce Pumpers Operation & Maintenance Manual* (PM-P-OM260) or the *Pierce Ultimate Configuration (PUC) Pumpers Operation & Maintenance Manual* (PM-P-OM420) as well as the pump manufacturer's literature provided with the unit.

5-9. Water Fording Capability

5-9.1 General Fording Instructions

CAUTION

Water fording is not recommended. Any depth of water which may partially submerge the axles or greater is to be avoided. Water fording can cause component damage, corrosion, or catastrophic failure to engine, transmission, and electrical systems.

Engine hydrostatic lock may result from water fording. Hydrostatic lock is caused by the entry of water through the engine air intake system and/or water contamination of the fuel system. Water is drawn into the engine and “lock-up” the engine. Hydrostatic lock most frequently occurs during or just after fording. Hydrostatic lock may result in severe or catastrophic engine damage.

If the rear axle breathers are submerged for more than a brief period, drain and replace the lubricant. See axle manufacturer’s lubrication specifications found in the Service Manual. After fording, lubricate all grease fittings below the fording depth to displace water and contaminated grease. Failure to follow these precautions may lead to premature wear or damage to the axles, suspension, and driveline components.

For vehicles equipped with electromagnetic driveline retarders, turn off retarder before fording water. Inspect for debris and grease unit before returning the vehicle to service after fording. Failure to follow these precautions may lead to damage of the retarder.

Low engine tunnel designs in some Pierce Custom Chassis models locate the engine air intake at or below frame level. This configuration restricts the ability of the vehicle to ford shallow water. Certain chassis components, such as cooling fans and axle breathers, can also restrict the ability to ford water.

The depth of water that can be safely forded is affected by several factors including environmental and vehicle configuration. Therefore no definitive fording capability can be established. Avoid depths of water which may partially or fully submerge the axles.

Note the location of the air intake port on your Pierce apparatus and avoid operation in standing water that will cause water ingestion into the engine. Even splashing water from a seemingly shallow depth can be ingested through the air intake and into the engine.

If water is to be forded, it is done at the operator's risk. Follow these precautions:

- Never attempt water fording unless water depth is known to be a depth not exceeding the height of the axles, and the bottom is known to be hard.
- Secure loose objects on vehicle.
- Make sure battery caps are present and tight.
- Enter water slowly. Entering water too fast may cause water to splash into the air intake.
- Maintain an even vehicle speed while fording, not to exceed 5mph (8kph).
- Exit water in area with a gentle slope.

If water ingestion into the air intake system is suspected, or the vehicle has been driven in high water conditions, then the following procedures should be followed:

1. Check air intake for moisture.

Remove the air intake piping ahead of the air cleaner and check the filter for moisture. If the filter is only partially wet with some dry paper area, then the chances are very good that no water entered the engine. Allow the filter to dry or install a new filter.

2. Inspect components for damage.

If the entire filter element is saturated, then proceed to have the engine checked by an authorized service center. Check fan for cracks in blades or missing blades. Analyze samples of oil from the axles, engine, and transmission for water content. Change fluids as required.

5-9.2 Fording Water with Command Zone™ Vehicles

CAUTION

After any high water use where the boxes are partially or fully submerged, they should be opened and inspected for moisture. If water has entered the box, allow to dry completely before using the vehicle.

Electrical distribution boxes may be located under the driver's side battery box or under the cab between the frame rails. Chassis rear distribution is located behind the fuel tank on units with aerial devices and in the substructure on pumpers. Even though these distribution boxes are not waterproof, they can be carefully submerged since the components are waterproof.

If water has entered the box, inspect the lid seal and ALL wires that pass through for leaks. Seal, or repair as instructed by Pierce Customer Service.

5-10. Winch Operation

⚠ WARNING

Make only straight winch pulls, and do not double the cable back to the vehicle using a snatch block. Failure to observe these limitations may over-stress the bumper or winch mounting and cause component failure leading to property damage, personal injury, or death.

Pinch Hazard.

Keep hands away from cable and drum.

Pinching fingers or body parts will injure or kill.

This vehicle may be equipped with a wire rope winch. Before operating a wire rope winch, walk around the vehicle, looking around and beneath the vehicle to ensure that there are no people in the area. If there are people anywhere in the area, warn them that you will be operating devices on the vehicle that are a hazard and command them to move to a safe location.

Read the winch operators manual (included in the Pierce Service Manual) carefully before operating the winch and follow all winch manufactures safety precautions and guidelines.

Exercise extreme caution when operating any winch device. Inspect the cable carefully before operation to ensure that there are no cut strands, kinks, or corrosion. Operate the winch only with the remote control unit when under load and stand well clear of the path of the cable should it fail. Orient the vehicle so that the winch cable will pull in a line perpendicular to the axis of the winch drum (no side pulls).

Anywhere wire rope contacts other mechanical parts such as the winch drum, pulleys, sheaves, roller guides, or features on the load, a pinch hazard exists. Even if the winch drum is guarded, the opening through which the cable passes can present a pinch hazard. If the winch drum is not guarded, keep away from it during operation. Follow lock-out or tag-out procedures before working on or around a winch.

Follow these safe practices during winch operation:

- Always stand clear of wire rope and load during operation.
- Never touch wire rope or hook while in tension or under load.
- Never touch wire rope or hook while someone else is at the control switch or during winching operation.
- Never touch wire rope or hook while remote control is plugged into winch.
- Always stand clear of wire rope and load and keep others away while winching.

Gloves and clothing

Wire rope, through use, will develop “barbs” which can slice skin. It is extremely important to wear protective gloves while handling the wire rope. Avoid loose fitting clothes or anything that could become entangled in the wire rope and other moving parts.

Engine Exhaust After Treatment Systems

5-11. Introduction

NOTE: Applies to all U.S. Domestic vehicles manufactured after 2007 and some export vehicles.

Your Pierce apparatus is equipped with a specialized exhaust equipment designed to meet tiered EPA regulations, based on both calendar year and vehicle usage (i.e. on-road or off-road), to reduce soot (partially burned fuel particles), ash (partially burned oil particles), and nitrogen oxide (NO_x) emissions.

5-11.1 Emissions Equipment and Functions

Figure 5-1: Typical After Treatment System Components (2010 and Later EPA Engines)

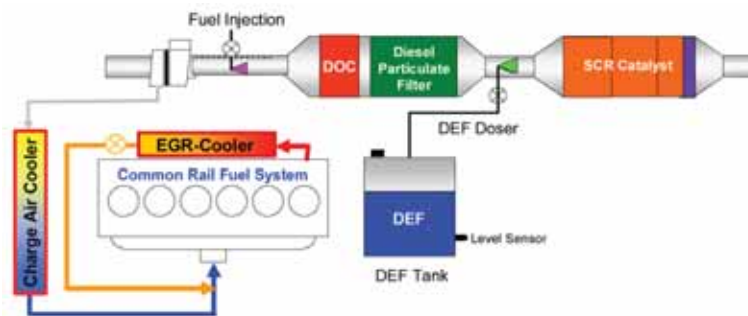

A0062









The major after-treatment devices used with the engine in your Pierce® fire apparatus may include:

- After Treatment Device (ATD), a special exhaust canister which has replaced the typical muffler. This canister contains a Diesel Oxidation Catalyst (DOC) and a Diesel Particulate Filter (DPF). The DPF will trap particulate matter or soot and ash while the engine is running. Soot accumulation in the DPF requires periodic self-cleaning through a process called regeneration.
 - Regeneration may occur naturally when the exhaust is hot enough to burn the soot off.
 - Regeneration may require intervention, either by the engine ECU or operator intervention, by injecting a small amount of fuel into the DOC, which raises exhaust temperatures enough to burn off accumulated soot.
 - See *“Cummins Regeneration”* on [page 5-23](#) or *“Detroit Diesel ATD Regeneration”* on [page 5-28](#) depending on your engine.
- Selective Catalyst Reduction (SCR) device. The SCR is a catalytic converter that uses vaporized diesel exhaust fluid (DEF), fed by a tank., to reduce nitrogen oxide (NO_x) emissions created during the combustion process.
- Diesel Exhaust Fluid (DEF). Also known as DEF, urea, or Ad-Blue, a solution of 32.5% urea and deionized water, which breaks down into ammonia (NH₃) during a chemical reaction in a decomposition reactor through a process known as hydrolysis. The NO_x and ammonia (NH₃) pass into the SCR element where a catalytic reaction takes place, converting the NO_x into harmless nitrogen gas (N₂) and water vapor (H₂O).
- Related indicator lamps on the driver display to alert the operator of the after-treatment equipment status. Light functionality is explained in *“After Treatment Device Indicator Lights - Cummins Engines”* on [page 5-23](#). and *“After Treatment Device Indicator Lights - Detroit Diesel”* on [page 5-28](#).
- 2013 EPA and later emissions requirements include engines receiving an upgraded engine ECU with fully-integrated On-Board Diagnostics (OBD). The drive engine indicator panel also includes an additional Malfunction Indicator Lamp (MIL).

5-12. Cummins Regeneration

5-12.1 After Treatment Device Indicator Lights - Cummins Engines

Table 5-1: Cummins Engine Instrument ATD Panel Lights

	<p>The amber Check Engine, or Engine Warning, light indicates a non-critical system fault with the engine has occurred. The operator can drive the vehicle to the end of their shift and call service to remedy the problem.</p>
	<p>The red Stop Engine light indicates a serious engine fault that may result in engine damage has occurred and the vehicle should be shut down as soon as it is safe to do so. The engine should remain shut down until serviced by an authorized dealer.</p>
	<p>The Malfunction Indicator (MIL) light illuminates when a fault has occurred on an emission related component. The engine and after treatment system should be diagnosed and serviced at the next available opportunity.</p>
	<p>If the MIL and Stop Engine Lamp illuminate together, the vehicle should be stopped as soon as it is safe to do so. The vehicle should be serviced by an authorized dealer.</p>
	<p>The Diesel Particulate Filter (DPF) light will illuminate when a regeneration is necessary. There are progressive stages of need for regeneration indicated by this light:</p>
 <p>ON SOLID</p>	<p>1. On solid (low to medium levels of particulate build up). The vehicle requires regeneration but should be able to complete its mission before a regeneration is performed.</p> <ul style="list-style-type: none"> — Ensure the Regen Inhibit Switch is not activated. — Initiate a DPF regeneration by switching to a more challenging duty cycle (such as highway driving for at least 20 minutes or pumping) — OR perform a parked regeneration.
 <p>FLASHING</p>	<p>2. Flashing (medium to high levels of particulate build up). The vehicle requires a regeneration as soon as possible.</p> <ul style="list-style-type: none"> — Perform a regeneration by switching to a more challenging duty cycle or a parked regeneration.
 <p>FLASHING</p>	<p>3. Flashing with amber Check Engine light (high level of particulate build up). A DPF regeneration is required immediately.</p> <ul style="list-style-type: none"> — An automatic regeneration will not initiate. The operator must perform a parked regeneration.
 <p>FLASHING</p>	<p>4. If a parked regeneration is not performed the red Stop Engine lamp will illuminate.</p> <ul style="list-style-type: none"> — As soon as it is safe to do so, the vehicle should be stopped and remain shut down until serviced by an authorized dealer.



The **High Exhaust System Temperature (HEST)** light indicates an active regeneration has been initiated and exhaust system temperatures are elevated above normal levels. The HEST light will remain on until exhaust temperatures have dropped below 977°F (525°C). If the HEST light is ON and the vehicle speed has dropped below the threshold of 5 miles per hour, the light will remain ON until the vehicle speed increases ~3 mph back above the speed threshold and the regeneration process finishes.

5-12.2 Passive Regeneration

Passive regeneration can occur during normal engine operation, typically at higher engine speeds (i.e. highway driving) and/or high loads, when exhaust temperatures naturally get high enough to oxidize the soot in the DPF. No engine ECU or operator intervention is required, and the operator will not see a difference in vehicle performance during the process.

- No extra fuel is used, and excessive exhaust temperatures do not occur during passive regeneration.
- The DPF light may temporarily illuminate and extinguish if soot levels reach moderately high levels, but because conditions allow, the passive regeneration process reduces the soot load naturally.

5-12.3 Active Regeneration

Active regeneration is controlled by the engine ECU. The active regeneration process removes collected soot in the DPF by injecting a small amount of diesel fuel into the exhaust stream. This raises the exhaust temperature to provide the heat needed to burn off the accumulated soot and regenerate the DPF.

Active Regeneration can happen while the truck is being driven, when in stationary truck operations, or during pumping operations.

- The need for active regeneration occurs more frequently within low speed, low load, or stop and go conditions.
- The DPF lamp illuminates when regeneration is needed. When the DPF light turns on, the operator can:
 - Provide assistance to the engine by either changing the duty cycle to allow the engine ECU to initiate the regeneration (Automatic Active Regeneration), or:
 - Manually initiate a parked regeneration using the regeneration switch, which is located in the cab within reach of the driver (Parked / Stationary Regeneration).

5-12.3a Automatic Active Regeneration During Driving or Pumping Conditions

The engine ECU will automatically activate a regeneration when the following vehicle conditions are satisfied:

- DPF light illuminates (soot is accumulated in the DPF filter) and the ECU looks for opportunities to regenerate.
- Sufficient exhaust flow and temperature conditions (engine fully warm and under load; typical pumping or highway driving conditions should be adequate).
- Speedometer showing 5 mph or higher vehicle speed, or in pumping mode.

When the ECU initiates the regeneration, exhaust system temperatures will rise, and the HEST lamp will illuminate with temperatures above 977°F (525°C). Breaking any of the required conditions will stop the regeneration process. If excessive soot build up remains after the process, the dash lights will indicate the appropriate indication stage for further regeneration. No engine speed or load changes will occur during regeneration in pumping or driving modes.

Automatic active regeneration can be temporarily suspended using the regeneration inhibit switch. See [“Regeneration Inhibit” on page 5-27](#).

5-12.4 Parked Regeneration

WARNING

Parked Regeneration causes high exhaust gas temperatures at zero vehicle speed. Keep personnel away from exhaust outlet to avoid serious burns and injury.

Do not perform parked regeneration in an enclosed area (i.e. indoors). All internal combustion engines give off hazardous fumes and gasses while running. Inhalation of exhaust fumes can cause death.

Do not sit in a parked vehicle for any extended amount of time with the engine running. Exhaust fumes could leak into the cab area and death can result.

CAUTION

Do not perform parked regeneration while connected to an exhaust extraction system. Damage to the exhaust extraction system may result.

Parked regeneration, also known as stationary or manual regeneration, is an active regeneration that is performed by the operator while the vehicle is parked. Follow this procedure to safely perform a parked regeneration.







IMPORTANT: If a parked regeneration is attempted, and the engine speed does not increase, contact your engine dealer for assistance.

Table 5-2: Cummins Parked Regeneration Engine Speeds

ENGINE TYPE	ISM	ISL/ISC	ISX 11.9	ISX 15
PARKED REGEN RPM	1400	1000	960	900

NOTE: The apparatus does not need to be taken out of service to complete a parked regeneration. See *"Canceling Stationary Regeneration"* on [page 5-26](#).

Table 5-3: Performing A Parked Regeneration (Cummins)

						
DPF LAMP MUST BE ON OR FLASHING	STOP IN SAFE LOCATION	SET PARKING BRAKE	SET SAFE ZONE AROUND EXHAUST	FOOT OFF THROTTLE, BRAKE	HOLD REGEN SWITCH 5 SECONDS	MONITOR AREA STOP ENGINE FOR UNSAFE CONDITIONS!!
PRESSING BRAKE, THROTTLE, REGEN INHIBIT SWITCH WILL STOP REGENERATION PROCESS						
<ol style="list-style-type: none"> Stop vehicle completely, transmission in N (neutral), and set the parking brake. <ul style="list-style-type: none"> Park on a clean surface that will not melt or burn (clean concrete or gravel, not grass or asphalt). Engine control should be from accelerator pedal (not PTO, remote PTO, cruise, etc) PTO and running at normal idle (high idle should be OFF). Clear exhaust outlet area 5 ft of any items, gasses, vapors that can melt, burn or explode. If indoors, exhaust discharge pipe must be rated at least 1500°F (816°C). Keep foot off the throttle pedal and the brake pedal. 						
<div style="border: 1px solid black; padding: 5px; background-color: yellow;">CAUTION</div> <p>STAY with the vehicle. Monitor the area during the operation. if any unsafe conditions occur, shut off engine immediately!</p> <p>NOTE: Diesel Particulate Filter (DPF) lamp must be ON in order to start a stationary regeneration.</p> <ol style="list-style-type: none"> With the engine running, press and hold the vehicle's regeneration switch for several seconds. <ul style="list-style-type: none"> Engine speed increases. The turbocharger may make a different sound during the event. DEF lamp turns OFF. As hydrocarbons are added, temperature goes up. HEST lamp illuminates when exhaust temperature reaches 977°F (525°C). Regeneration may take 20-40 minutes or more, depending on soot level. Exhaust temps stay high at least 3-5 minutes after completion. To stop a regeneration before completion, depress throttle pedal, release parking brake, press the regeneration inhibit switch, or turn off the engine. When the regeneration is complete, the engine returns to normal idle speed and operation. <ul style="list-style-type: none"> If excessive soot remains in the filter, the DPF light(s) will return to the appropriate stage until another regeneration occurs. Repeat parked regeneration. If the DPF light still remains on, call for service. 						

After completion of regeneration, the HEST light will remain illuminated until the exhaust outlet temperature is below 977°F (525°C) or the vehicle speed exceeds 5 mph.

5-12.4a Canceling Stationary Regeneration

If it is necessary to interrupt a stationary/parked regeneration before completion (such as in order to respond to an emergency call) the operation may be canceled by depressing the throttle, releasing the parking brake, or pressing the Regen Inhibit Switch. If the DPF lamp is still illuminated after the call, the operator can re-initiate the stationary regeneration process as normal. If the DPF lamp has extinguished in the meantime, the vehicle was able to complete the regen process on its own.

5-12.5 Regeneration Inhibit

WARNING

Inhibiting or suspending regeneration too frequently can result in exhaust restriction, higher fuel consumption, and engine performance loss due to soot build-up in the DPF.

If the DPF has reached system limits (DPF light flashes with Check Engine Light) the operator needs to take action such as removing the truck from a high-load mission, and initiating an active regeneration or a parked regeneration.

The Regeneration Inhibit Switch can be used to temporarily suspend an in-process active regeneration. This may be done when the regeneration is going to occur in a location or situation that is not ideal and must be postponed. An indicator will appear on the dash panel when this mode is activated.

- The regen inhibit switch should not be used for normal operation. It should only be used for hazardous environments.
- Overuse of the regeneration inhibit feature **will** lead to more frequent need of parked/stationary regeneration, or the need for servicing and/or replacing the Diesel Particulate Filter (DPF).

5-12.5a Regeneration Inhibit While Pumping

A common misconception is that regeneration will negatively affect pumping operations. Any time the engine detects a need for regeneration, it is looking for conditions (such as engine speed and temperature) to start an active regeneration. If the pump is engaged, the regeneration process should not affect the engine speed.

5-12.6 Maintenance







Regeneration removes soot from the DPF, but accumulated ash remains in the filter. Over time the DPF must be removed, disassembled, and cleaned in a special machine to remove the ash build-up.

- CEL will illuminate and a fault code will be set when ash removal is necessary.
- The Cummins maintenance interval is 200,000-400,000 miles, or up to 6,750 hours, which is dependent on duty cycle, type of oil used, and oil consumption rate.
- Using CES20081/API CJ-4 oil will maximize the DPF maintenance interval.

5-13. Detroit Diesel ATD Regeneration

5-13.1 After Treatment Device Indicator Lights - Detroit Diesel

Table 5-4: Detroit Diesel ATD Instrument Panel Lights

	<p>The amber Check Engine Lamp (CEL) warning light indicates a fault with the engine controls or aftertreatment controls and/or components has occurred. The operator can drive the vehicle to the end of their shift and call service to remedy the problem.</p>
	<p>The red Stop Engine warning light indicates a major engine fault that may result in engine damage. The operator should move the vehicle to a safe location and shutdown the engine.</p>
	<p>The Malfunction Indicator (MIL) light provides an indication to the vehicle operator that a fault has occurred on an emission related component. This light may illuminate at the same time as the Check Engine light. The operator can drive the vehicle to the end of their shift and call service to remedy the problem.</p>
	<p>The Diesel Particulate Filter (DPF) light will illuminate when a regeneration is necessary. There are progressive stages of need for regeneration indicated by this light:</p>
 <p>ON SOLID</p>	<p>1. DPF on solid (low to medium levels of particulate build-up). The vehicle requires regeneration but should be able to complete the current mission. Perform a regeneration in a reasonable amount of time.</p> <ul style="list-style-type: none"> — Ensure the Regen Inhibit Switch is not activated. — Initiate a DPF regeneration by switching to a more challenging duty cycle (such as highway driving for at least 20 minutes or pumping) — OR perform a parked regeneration.
 <p>FLASHING</p>	<p>2. DPF flashing (medium to high levels of particulate build-up). DPF reaching system limits and regeneration required as soon as possible.</p> <ul style="list-style-type: none"> — Perform a parked regeneration as soon as possible OR change to a more challenging duty cycle.
 <p>FLASHING</p>	<p>3. DPF flashing, CEL lit. System has REACHED limitations.</p> <ul style="list-style-type: none"> — Parked regeneration must be performed in a safe location. If lamps remain on after parked regeneration, repeat the parked regeneration. If second attempt fails, have vehicle serviced.
 <p>FLASHING</p>	<p>4. DPF flashing, CEL lit, and Stop Engine light lit. System has EXCEEDED limitations. ENGINE SHUTDOWN.</p> <ul style="list-style-type: none"> — Parked regeneration must be performed in a safe location. If lamps remain on after parked regeneration, repeat the parked regeneration. If second attempt fails, have vehicle serviced. — Engine can be restarted, but a parked regeneration must be initiated within 30 seconds or engine will shut down.



The **High Exhaust System Temperature (HEST)** light indicates an active regeneration has been initiated and exhaust system temperatures are elevated above normal levels. The HEST light will remain on until exhaust temperatures have dropped below 977°F (525°C). If the HEST light is ON and the vehicle speed has dropped below the threshold of 5 miles per hour, the light will remain ON until the vehicle speed increases ~3 mph back above the speed threshold and the regeneration process finishes.

5-13.2 Passive Regeneration

Passive regeneration can occur during normal engine operation, typically at higher engine speeds (i.e. highway driving) and/or high loads, when exhaust temperatures naturally get high enough to oxidize the soot in the DPF. No engine ECU or operator intervention is required, and the operator will not see a difference in vehicle performance during the process.

- No extra fuel is used, and excessive exhaust temperatures do not occur during passive regeneration.
- The DPF light may temporarily illuminate and extinguish if soot levels reach moderately high levels, but because conditions allow, the passive regeneration process reduces the soot load naturally.

5-13.3 Active Regeneration

Active regeneration is controlled by the engine ECU. The active regeneration process removes collected soot in the DPF by injecting a small amount of diesel fuel into the exhaust stream. This raises the exhaust temperature to provide the heat needed to burn off the accumulated soot and regenerate the DPF.

Active Regeneration can happen while the truck is being driven, when in stationary truck operations, or during pumping operations.

- The need for active regeneration occurs more frequently within low speed, low load, or stop and go conditions.
- The DPF lamp illuminates when regeneration is needed. When the DPF light turns on, the operator can:
 - Provide assistance to the engine by either changing the duty cycle to allow the engine ECU to initiate the regeneration (Automatic Active Regeneration), or:
 - Manually initiate a parked regeneration using the regeneration switch, which is located in the cab within reach of the driver (Parked / Stationary Regeneration).

5-13.3a Automatic Active Regeneration During Driving or Pumping Conditions

The engine ECU will automatically activate a regeneration when the following vehicle conditions are satisfied:

- DPF light illuminates (soot is accumulated in the DPF filter) and the ECU looks for opportunities to regenerate.
- Sufficient exhaust flow and temperature conditions (engine fully warm and under load; typical pumping or highway driving conditions should be adequate).
- Speedometer showing 5 mph or higher vehicle speed, or in pumping mode.

When the ECU initiates the regeneration, exhaust system temperatures will rise, and the HEST lamp will illuminate with temperatures above 977°F (525°C). Breaking any of the required conditions will stop the regeneration process. If excessive soot build up remains after the process, the dash lights will indicate the appropriate indication stage for further regeneration. No engine speed or load changes will occur during regeneration in pumping or driving modes.

Automatic active regeneration can be temporarily suspended using the regeneration inhibit switch. See *“Regeneration Inhibit”* on [page 5-32](#).

5-13.4 Parked Regeneration

⚠ WARNING

Parked Regeneration causes high exhaust gas temperatures at zero vehicle speed. Keep personnel away from exhaust outlet to avoid serious burns and injury.

Do not perform parked regeneration in an enclosed area (i.e. indoors). All internal combustion engines give off hazardous fumes and gasses while running. Inhalation of exhaust fumes can cause death.









Do not sit in a parked vehicle for any extended amount of time with the engine running. Exhaust fumes could leak into the cab area and death can result.

CAUTION

Do not perform parked regeneration while connected to an exhaust extraction system. Damage to the exhaust extraction system may result.

Parked regeneration, also known as stationary or manual regeneration, is an active regeneration that is performed by the operator while the vehicle is parked. Follow this procedure to safely perform a parked regeneration.

Table 5-5: Performing A Parked Regeneration (Detroit)

							
DPF LAMP MUST BE ON OR FLASHING	STOP IN SAFE LOCATION	CYCLE TRANSD TO N	CYCLE PARKING BRAKE	SET SAFE ZONE NEAR EXHAUST	FOOT OFF THROTTLE, BRAKE	HOLD REGEN SWITCH 5 SECONDS	MONITOR AREA. STOP ENGINE IF UNSAFE!
TURNING KEY OFF, PLACING TRUCK INTO GEAR, OR RELEASING PARKING BRAKE WILL STOP REGENERATION PROCESS							
<ol style="list-style-type: none"> 1. Move the truck to a safe location that prevents the high exhaust heat from causing damage to the road surface or the ground. <ul style="list-style-type: none"> • Park on a clean surface that will not melt or burn (clean concrete or gravel, not grass or asphalt). • Engine control should be from accelerator pedal (not PTO, remote PTO, cruise, etc) PTO and running at normal idle (high idle should be OFF). • Clear exhaust outlet area 5 ft of any items, gasses, vapors that can melt, burn or explode. • If indoors, exhaust discharge pipe must be rated at least 1500°F (816°C). 2. Cycle the transmission out of neutral and back into neutral.* 3. Cycle the parking brake OFF to ON - once an ignition cycle (Parking Brake must remain ON).* 							
CAUTION							
STAY with the vehicle. Monitor the area during the operation. if any unsafe conditions occur, shut off engine immediately!							
NOTE: Diesel Particulate Filter (DPF) lamp must be ON in order to start a stationary regeneration.							
<ol style="list-style-type: none"> 4. With the engine running at idle, and the vehicle parked with the speedometer at 0 mph, press and hold the vehicle's regeneration switch for 5 seconds. <ul style="list-style-type: none"> • Engine speed increases. (Series 60: 1600 RPM. DD13: 1100 RPM). • DEF lamp flashes then turns OFF. As hydrocarbons are added, temperature goes up. HEST lamp flashes once every ten seconds, then illuminates when exhaust temperature reaches 977°F (525°C). • Regeneration may take up to 40 minutes or more, depending on soot level. • Exhaust temps stay high at least 5 minutes after completion. 5. To stop a regeneration before completion, press the regeneration inhibit switch, place the vehicle in gear, release the parking brake, or turn off the engine. 6. When the regeneration is complete, the engine returns to normal idle speed and operation. <ul style="list-style-type: none"> — If excessive soot remains in the filter, the DPF light(s) will return to the appropriate stage until another regeneration occurs. Repeat parked regeneration. If the DPF light still remains on, call for service. 							

* These steps not required on GHG14 engines or later.

DD13 Operators may notice a slight increase in vehicle vibration during regeneration. The DD13 engine will fire three cylinders during regeneration and operate the other three in engine brake mode. This increases engine load during regeneration and increases exhaust temperatures.

Upon completion of parked regeneration, the following should occur:

1. The HEST light will remain illuminated until the exhaust outlet temperature is below the temperature threshold or the vehicle speed exceeds 5 mph.
2. The DPF light will turn off, along with all other associated warning lights. If the Check Engine light, Stop Engine light or MIL are still illuminated, a fault condition exists that should be diagnosed by a Detroit service representative.

Parked regeneration is not allowed when the DPF light is not illuminated.

5-13.4a Canceling Stationary Regeneration

If it is necessary to interrupt a stationary/parked regeneration before completion (such as in order to respond to an emergency call), the driver can toggle the regeneration switch to ON for five seconds. The DPF light will flash on for one second to show acceptance of the cancellation request and then return to idle. Turning the ignition off, placing the transmission in gear, or releasing the parking brake will also cancel the regeneration.

If a parked regeneration is interrupted, the DPF light will illuminate, indicating the need for further regeneration. The DPF light will remain illuminated until the regeneration is completed through either automatic regeneration (by driving or pumping) or by resuming a parked regeneration.

5-13.5 Regeneration Inhibit

▲ WARNING

Inhibiting or suspending regeneration too frequently can result in exhaust restriction, higher fuel consumption, and engine performance loss due to soot build-up in the DPF.

If the DPF has reached system limits (DPF light flashes with Check Engine Light) the operator needs to take action such as removing the truck from a high-load mission, and initiating an active regeneration or a parked regeneration.

The Regeneration Inhibit Switch can be used to temporarily suspend an in-process active regeneration. This may be done when the regeneration is going to occur in a location or situation that is not ideal and must be postponed. An indicator will appear on the dash panel when this mode is activated.

- The regen inhibit switch should not be used for normal operation. It should only be used for hazardous environments.
- Overuse of the regeneration inhibit feature **will** lead to more frequent need of parked/stationary regeneration, or the need for servicing and/or replacing the Diesel Particulate Filter (DPF).

5-13.5a Regeneration Inhibit While Pumping

A common misconception is that regeneration will negatively affect pumping operations. Any time the engine detects a need for regeneration, it is looking for conditions (such as engine speed and temperature) to start an active regeneration. If the pump is engaged, the regeneration process should not affect the engine speed.

5-13.6 Maintenance











Regeneration removes soot from the DPF, but accumulated ash remains in the filter. Over time the DPF must be removed, disassembled, and cleaned in a special machine to remove the ash build-up.

- CEL will illuminate and a fault code will be set when ash removal is necessary.
- The maintenance interval for Detroit engines could be up to 300,000-400,000 miles, or between 9,000 and 10,250 hours, which is dependent on duty cycle, type of oil used, and oil consumption rate.
- Using CES20081/API CJ-4 oil will maximize the DPF maintenance interval.

5-14. Selective Catalytic Reduction (SCR) and DEF Operation

The operation of the SCR device requires Diesel Exhaust Fluid (DEF). The driver is responsible for filling the DEF reservoir to maintain the proper amounts of DEF fluid required by the engine. The DEF reservoir on Pierce custom fire apparatus is 4 1/2 gallons. The fluid level sensor transmits the fluid level directly to the Dosing Control Unit (DCU). The DCU is programmed with specific operational parameters which will trigger the DEF indicator as well as induce vehicle performance derates*.

Table 5-6: Cummins and Detroit DEF Fluid Indicator Lamps and Warnings

	The Diesel Exhaust Fluid (DEF) Level Low light (2010 EPA and later) indicates the fluid level has reached a low level and a refill is needed. The operator should refill the reservoir when refilling the vehicle with diesel fuel or at the end of their shift. Refilling the DEF tank under any of these conditions should extinguish the light.
NO LAMP	<ul style="list-style-type: none"> DEF level between full and 1/4 full: DEF Fluid Low light will remain OFF.
 ON SOLID	<ul style="list-style-type: none"> DEF level between 1/4 full and 1/8 full: DEF Fluid Low light will illuminate solid.
 FLASHING	<ul style="list-style-type: none"> DEF level below 1/8 full: DEF Fluid Low light will flash.
 FLASHING 	<ul style="list-style-type: none"> DEF level below 1/4 gallon: <ul style="list-style-type: none"> Cummins: DEF Fluid Low light flashing and amber Check Engine lit solid. The engine will induce a 25% engine torque derate*. Detroit: DEF Fluid Low light flashing and Check Engine illuminated. The engine will induce a 55 mph speed limit* and 25% engine torque derate*.
 FLASHING  	<ul style="list-style-type: none"> DEF tank empty and system can no longer maintain DEF pressure: <ul style="list-style-type: none"> Cummins: DEF Fluid Low light flashing, amber Check Engine lit solid, and MIL light lit solid. The engine will induce an engine torque derate* that begins a 25% and ramps to 40% at a rate of 1% per minute of operation. Detroit: DEF Low light flashing, Check Engine light and Malfunction Indicator Lamp (MIL) illuminated. The engine will induce a 55 mph speed limit* and 25% engine torque derate*.
 FLASHING   	<ul style="list-style-type: none"> DEF Tank Empty and ignored: <ul style="list-style-type: none"> Cummins: DEF Tank empty and ignored, engine intentionally shut down or in extended idle: DEF Fluid Low light flashing, amber Check Engine lit solid, red Stop Engine lit solid, and MIL light lit solid. The engine will induce an engine rpm limit of 1000 rpms*, a 5 MPH vehicle speed limit* and a 40% engine torque derate*. Detroit: DEF Tank Empty and ignored (fuel tank refilled by more than 30% or engine start after the consumption of more than 350 gallons of diesel fuel): DEF Low light flashing; Check Engine light, Stop Engine light, and MIL illuminated. The engine will induce a 5 mph speed limit* and a 25% engine torque derate*.

* Vehicle performance derates and speed limits do not apply to 2013 and later EPA engines.

Operating the Engine

5-15. Starting the Engine

Diesel engine starting motors require a significant amount of current during the starting process. Keep all unnecessary electronic loads turned OFF while starting the engine. Use the following steps for starting the engine:

1. Verify that the parking brake is engaged.
2. Place transmission shifter in **N** (Neutral).
3. Turn battery master switch to the ON position.
4. Move ignition switch to the ON position.
5. *Vehicles with Command Zone™*: Wait until prove out completes (approximately four seconds). If this is not done, it may cause intermittent alarms to occur.
6. *Vehicles equipped with Side Roll Protection System*: The Side Roll Protection System fault light should illuminate (bulb check). If the fault light does not illuminate, or remains lit after 30 seconds, contact your Pierce Dealer. The vehicle may be driven, but should only be done so with the knowledge that the Side Roll Protection System may be partially or completely inoperative. The cause of the fault indication must be corrected as soon as possible. See "*Side Roll Protection System (Optional)*" on [page 6-6](#) for additional information.

CAUTION

If the engine does not start within 15 seconds, release the starter buttons and allow the starter motor to cool for 60 seconds before attempting to start the engine again.

7. Push the starter button.
8. When engine starts, release the starter button.

5-16. Running the Engine

⚠ WARNING

Internal combustion engines give off hazardous fumes and gases while running. Do not operate the engine in an area where exhaust gases can accumulate, or serious injury or death may occur.

Diesel engine exhaust and some of its constituents are known to the State of California to cause cancer, birth defects, and other reproductive harm.

The exhaust system can get extremely hot without warning. Keep away from exhaust gas and do not park vehicle near flammable material. Do not touch exhaust pipes or parts. Hot metal and exhaust gas will burn skin.

5-16.1 Excessive Idling

CAUTION

All engine manufacturers warn against excessive engine operating time (greater than 5 minutes) at low idle speed, particularly during cold weather. Excessive idling can have the following detrimental effects on the engine:

- Fuel dilution of the lubricating oil
- Unburned fuel passing through to the exhaust system
- Carbon build-up in the cylinder
- Cylinder head valve sticking
- Smoking
- Reduced performance
- High hydrocarbon absorption

Additionally, torsional vibration levels for some engines may be higher at low idle speeds, leading to premature wear of PTO splined shafts or other engine driven components.

If it is necessary to idle the engine for more than 5 minutes, the fast idle switch should be activated to increase the engine speed to at least 1000 rpm.

5-16.2 Engine-Specific Operation Instructions

IMPORTANT: Refer to the engine operator's manual for additional information, troubleshooting, and safety instructions.

5-17. Stopping the Engine

CAUTION

Never stop the engine by turning off the battery switch, or alternator damage may result.

Running the engine at idle allows the lubricating oil and coolant to carry heat away from the combustion chamber, bearings, shafts, etc. This is especially important with turbocharged engines. The turbocharger contains bearings and seals that are subject to the high heat of combustion exhaust gases. While the engine is running, this heat is carried away by normal oil circulation. If the engine is stopped suddenly, the turbocharger temperature may rise as much as 100°F (56°C). This may result in seized bearings or loose oil seals. Failure to idle the engine for the proper length of time before shutdown can lead to reduced engine life or engine component failure.

1. Bring the truck to a complete stop using the service brakes.
2. Shift transmission into **N** (Neutral).
3. Set parking brake.
4. Idle engine for 3 to 5 minutes.
5. Turn ignition switch to OFF position.
6. Turn battery selector switch to OFF position.

5-18. Emergency Shutdown (*Optional*)

CAUTION

The emergency shutdown device is meant for occasional use only. Continual use of this device will place unnecessary stress on intake plumbing and engine parts and may lead to reduced component life.

The emergency shutdown feature provides positive shutdown capability even in the event that the engine is operated in an atmosphere rich in fuel vapors. The shutdown device is a clapper valve located in the air intake pipe or the charge air cooler pipe that blocks all airflow to the intake manifold. The valve is tripped electrically or pneumatically from a switch located at the driver's station or pump panel. Once the valve is tripped, it must be reset before the engine can be started again.

5-19. Cooling System

⚠ WARNING

Always allow the engine to cool before opening the pressure cap. Wrap a thick, heavy cloth around the cap. Push down, and turn the cap to the first notch position. Pause before opening completely to allow any remaining pressure to escape. Follow this procedure to avoid burns from hot steam or coolant.

Do not operate the engine if the cooling fan is worn, notched, bent, damaged in any manner, or comes in contact with any other chassis component while spinning, or personal injury or death may result.

CAUTION

The optional emergency radiator refill feature allows the engine cooling system to be replenished with water supplied by the fire pump and tank. This option should be used only in a true emergency. Use of this option could lead to cooling system contamination, clogging, water pump damage, or other problems. If this option is used, the cooling system should be flushed and refilled with properly conditioned, clean coolant as soon as possible.

If the coolant is extremely low and the engine is very hot, allow the engine to cool for at least 15 minutes before adding coolant to avoid thermal shock to the engine block resulting in serious engine damage or reduced component life.

Adequate coolant must be maintained in the cooling system to prevent engine overheat. Check the coolant level by observing the sight glass, coolant expansion tank, or by checking the low coolant warning indicator on the instrument panel electronic display (*if equipped*).

Refer to “*Antifreeze Type*” on [page 6-25](#) and the engine manufacturer operator’s manual for proper coolant selection, inhibitor levels, and mixing procedures.

Pierce Custom Chassis are configured to engage the fan during pumping operations. All 2010 EPA & 2013 EPA engines are configured to engage the fan clutch when the parking brake is applied and the pump is engaged. This is done to prevent water pressure fluctuations (that may occur when the fan engages and disengages), help cool the steering system, improve air conditioning performance, and cool exhaust components, particularly when trucks are operating at elevated high idles for extended periods of time.

5-19.1 Fan Clutch

⚠ WARNING

Fan clutches can engage and fan blades can spin without warning. Keep hands, hair, and clothes away from fan. Never operate the engine with personnel in the vicinity of the fan as the fan may engage without warning. Failure to heed this warning may lead to personal injury or death.

Engines equipped with a fan clutch will provide airflow to cool the engine when one or more of the following conditions are met.

- The engine coolant or air intake temperature reaches the engine manufacturer's preset temperature for fan engagement.
- Placing the truck in "pump mode" may activate the fan clutch.
- Activation of any generator PTO drive may engage the fan clutch.

5-20. Starting Engine Using Power From Another Vehicle

⚠ WARNING

Pierce Custom Chassis have a 12-volt negative ground electrical system. Before using jumper cables, make sure the booster vehicle also has a negative ground system (negative terminal attached to a metal part of the vehicle). If unsure of the booster vehicle's voltage or ground, do not attempt to jump start as personal injury or severe damage to the electrical system may result.

The following procedures must be performed exactly as outlined. Otherwise injury to the face, eyes, body, limbs, and respiratory system could result from fire or acid due to battery explosion. Property damage could also result.

CAUTION

To avoid damage to vehicle electronic components, voltage supplied to a vehicle's electrical system must not exceed 16.0 volts.

If the battery charge is insufficient to crank the engine, the following procedure may be used to supplement battery power.

1. To prevent shorting of the electrical system, remove metal rings, watches, or other metallic accessories and do not allow metal tools to contact positive terminal of battery.
2. Position the vehicles so the jumper cables will reach easily between the batteries. Do not allow the vehicles to touch.
3. Turn off all electric motors and accessories in each vehicle. Turn off all lights not needed to protect the vehicles or to light the work area. In each vehicle, stop the engine, turn off the warning light master switch.
4. Apply the parking brake and shift the transmission to **N** (Neutral) in both vehicles.
5. Connect the first jumper cable from the positive (+) terminal of the dead battery or the positive (+) terminal of the jump-start stud to the positive (+) terminal on the booster battery.

6. Connect one end of the second jumper cable to the negative (–) terminal on the booster battery, and the other end to the frame of the disabled vehicle at least 18 inches (450 mm) away from the battery. Do not attach the other end directly to the battery negative (–) terminal because a spark could occur and cause explosion of gases normally present around the battery.
7. With the jumper cables properly attached, start the engine of the vehicle with the good (charged) battery. Run the engine at moderate speed.
8. Start the engine in the vehicle with the discharged battery.

Remove the battery cables by reversing the above sequence exactly.

5-21. Operation of Engine in Fuel Rich Atmosphere

WARNING

Diesel engines do not require a spark for ignition and will continue to run as long as there is fuel available. Varying the amount of fuel introduced into the chambers controls the speed of a diesel engine. If the engine is operated in an atmosphere that is laden with fuel vapors such as is found at a fuel spill, the engine may increase speed uncontrollably. Turning the ignition switch or battery switch off in this situation will not affect the speed of the engine. Before operating a diesel engine in this type of environment, ensure that the vehicle is equipped with a means of shutting off the air intake supply to the engine and that the driver is present to operate the shutdown whenever the engine is running.

5-22. Air Restriction Indicator

A diesel truck engine may consume over 12,500 gallons of air for every gallon of fuel that it burns. The air cleaner element filters this air to ensure that dirt and dust are not allowed to contaminate the engine. A dirty air cleaner element is a common cause of air restriction. The result is too little air to burn all the fuel. Some of the excess fuel will cause a smoky exhaust and lost horsepower. In addition, the excess fuel washes lubricating oil off cylinder walls resulting in seized pistons and bearing failures. Regular inspection and maintenance of the air intake tubing and connections is important to prevent any unfiltered air from entering the engine.

A pressure sensor located in the engine air intake tube triggers the air intake restriction indicator light located on the dash panel.

On multiplexed vehicles, air restriction is monitored by the Command Zone™ system. During a restricted air intake condition, a text message, caution light, and chime are activated on the Command Zone™ Information Center (CZIC).

If the light or CZIC remains activated, any of the following conditions may be present:

- The air cleaner filter element is dirty and requires replacement.
- The air cleaner filter element has become saturated with water over most or all of the element surface.
- The ductwork or screen in front of the air cleaner has become plugged or otherwise restricted.

The actual level of restriction at which the light comes on varies between chassis models and engine options.

5-23. Fluid Requirements

5-23.1 Diesel Fuel Requirements

⚠ WARNING

Never blend gasoline, gasohol, alcohol, or other volatile substances with diesel fuel. This practice creates an extreme fire or explosive hazard that could cause property damage, personal injury, or death.

⚠ CAUTION

2010 EPA & 2013 EPA engines require the use of specific oil and diesel fuel. The diesel fuel to be used shall be Ultra Low Sulfur Diesel (ULSD) fuel containing 15 parts per million (PPM) sulfur content or less. Make sure the pump station being used has the proper fuel type when filling your fuel tank. If ultra-low-sulfur fuel is not used, the engine will not meet emissions regulations, and the After Treatment Device (ATD) can be damaged. Refer to the engine manufacturer's operation manual for additional fuel specifications.

Filling the fuel tank with other liquids can result in premature failure of the engine and/or emission components.

Refer to the engine manufacturer's operator's manual for proper fuels, additives, and fueling procedures.

5-23.2 Engine Oil Requirements

⚠ CAUTION

Detroit engines only: Engine oil must have sulfate ash levels less than 1.0 weight %. Oils meeting this requirement are marked as API CJ-4 oil. Using any other oil will cause damage to the ATD. Using oil that is not CJ-4 compliant for extended periods of time will damage components and require replacement of the ATD by an approved service facility.

Cummins engines only: Cummins Inc. recommends that 2010 EPA and beyond engines use a high quality 15W-40 multi viscosity heavy-duty engine oil that meets the requirements of Cummins Engineering Standard CES20081/API CJ-4/SL for maximum DPF maintenance intervals. Cummins allows the use of CES20078/API CI-4/SL oil with no change in oil drain intervals. However, the after-treatment maintenance interval will be reduced with the use of CES20078/CI-4 oil.

Maintain engine oil at the proper level. Use engine dipstick to check oil level. Refer to the engine manufacturer's operator's manual for additional information on engine oil types and procedures.

5-23.3 Diesel Exhaust Fluid (DEF) - 2010 EPA Engines and Beyond

Acceptable DEF fluid used shall meet ISO 22241-1 or DIN 70700 specifications. DEF fluid should be stored at temperatures between 10°F - 90°F and has a maximum shelf life of 12 months.

Figure 5-2: Typical DEF Reservoir Location



The Diesel Exhaust Fluid reservoir is typically located in the driver's side rear wheel fender behind the forward air bottle storage door. The DEF reservoir location on your apparatus may be different, depending on the rear body design. The reservoir has a blue cap and is accompanied by a DEF fluid only label.

CAUTION

Filling the DEF tank with other liquids can result in premature failure of the engine and/or emissions components.

In the event that the incorrect fluid has been added to the DEF tank, such as, but not limited to:

- Water
- Diesel Fuel
- Hydraulic Fluid
- Coolant
- Windshield Washer Fluid

Contact Pierce Customer Service to determine the appropriate repair action.

If only water has been added to the DEF tank, drain the DEF tank, flush with distilled water and refill with new and/or known good DEF.

CAUTION

Do NOT add any chemicals/additives to the DEF in an effort to prevent freezing. If chemicals/additives are added to the DEF, the aftertreatment system may be damaged.

DEF will freeze around 11°F (-12°C). The DEF system on the vehicle is designed to accommodate this and does not require any intervention from the operator.

5-24. Hand Throttle

⚠ WARNING

Never attempt to use a hand throttle as a cruise control. Doing so may cause lack of vehicle control resulting in property damage, personal injury, or death.

5-25. Cold Weather Operation

CAUTION

Because diesel engines are highly efficient, they use very little fuel while idling. As a result, idling in cold weather will not heat the engine to its normal operating temperature. Operation of a diesel engine at low idle for extended periods of time can cause engine damage. The following cold weather guidelines must be followed:

- Avoid extended idling (beyond 10 minutes) whenever possible.
- Use a minimum 45 Cetane diesel fuel or utilize Cetane index improvers from a reputable manufacturer.
- Maintain a minimum of 1250 rpm idle by use of the hand throttle or high idle system. Always make sure that parking brake is applied and transmission is in neutral before applying hand throttle.
- Maintain engine cooling system.
- For pumpers: Shut off water flow to the auxiliary cooler using the valve at the pump panel and avoid the use of pump panel heaters except when essential.
- Use engine block heaters when possible.

As diesel engines have increased in efficiency, the amount of waste heat available to be drawn from the coolant has decreased, particularly when operated at idle under a no-load condition. In cold weather with all the heaters operating, the engine may not reach warm operating temperatures unless it is placed under load.

5-25.1 Cold Weather Pumper Operation

- Ensure that the engine cooler valve on the pump panel is in the closed position. This valve shuts off the flow of tank water to the auxiliary engine cooler. This cooler is only required during pumping in high ambient conditions.
- Keep the pump panel heater (if so equipped) in the off position when not required. This will draw less heat from the engine during warm-up.
- Turn the crew cab heater fan to low or off when the crew cab is not occupied. This will draw less heat from the engine during warm-up.
- Operation of the engine in a high-idle mode will increase the engine heat output somewhat, but is of limited benefit unless the engine is under load. To provide a load on the engine during long periods of idle time, operate the pump in the recirculation mode with the engine at 1500 rpm.

Refer to the engine manufacturer's operator's manual for further information.

Winter Front Usage

CAUTION

The use of a winter front increases the need for the operator to carefully monitor engine and transmission temperatures. Remove the winter front before operating the vehicle in warm temperatures. Excessive engine and transmission operating temperatures created by the inappropriate use of a winter front can cause operational failure leading to costly equipment damage.

Winter fronts are not necessary except in extremely cold temperatures or when light engine loads are combined with a high rate of engine idling. If a winter front is used, it must be placed over the grill on the outside of the vehicle only, never directly onto the face of the charge air cooler or radiator. On Pierce Custom Chassis this spacing will maintain a gap of 6 to 14 inches between the winter front and the heat exchanger cores. This installation will restrict the flow of air through the cooling system to that which can be drawn from below the bumper and will avoid cutting off cooling airflow entirely.

Driving the Vehicle

5-26. Transmission

5-26.1 Automatic Transmission

⚠ WARNING

Whenever it becomes necessary to leave the vehicle, even momentarily, while the engine is running, place the transmission shift selector in Neutral, set the parking brake, and chock the wheels. Failure to follow this procedure may lead to loss of vehicle control resulting in possible property damage, personal injury, or death.

The Allison automatic transmission supplied with most Pierce Custom Chassis will only start in **N** (Neutral). Select **D** (Drive) mode for normal driving. Completely stop the vehicle before shifting from any forward range to **R** (Reverse). Turn off the vehicle high idle switch before attempting to shift from **N** (Neutral) to **D** (Drive) or **R** (Reverse). For further information refer to the Allison Transmission Operator's Manual.

5-26.2 Transmission Operating Temperature

NOTE: The transmission temperature gauge does not indicate the sump temperature. The gauge indicates the temperature of the oil as it exits the torque converter and before the oil enters the transmission cooler. This reading provides a much more immediate indication of temperature rise due to heavy use or retarder applications. If the sump fluid temperature reaches 250°F, the Electronic Control Unit (ECU) will inhibit operation in the higher ranges.

Maximum sump operating temperature is 250°.

On multiplexed vehicles, this information is monitored by the Command Zone™ system. During a high temperature condition, a text message, caution light, and chime tone are displayed on the Command Zone™ Information Center (CZIC).

5-26.3 Neutral to Drive Shift Growl - Allison MD Transmission

A growling noise may sometimes be heard in the cab when shifting the transmission from **N** (Neutral) to **D** (Drive). This is caused by electric solenoids within the transmission that control (modulate) the clutch hydraulic pressure. These solenoids modulate clutch pressure by turning on and off very fast, similar to the operation of an alternator voltage regulator. Increasing or decreasing the time the solenoid spends in the "on" state controls the clutch pressure.

The rapid on-off operation of the solenoids results in pressure oscillations at the clutch. These pressure oscillations result in a cyclical piston load on the clutch, which can cause torque oscillations. These torque oscillations are transferred through the transmission and driveline, into the axle, axle shafts, and any suspension members attached to the drivetrain.

If vehicle components such as body panels, drivelines, and frame members are excited by the frequency of the torque oscillations, an audible noise may be heard inside the cab. These torque oscillations (and resulting noise) are well below the design limits of the transmission and do not affect the life of the transmission or other vehicle driveline components.

5-26.4 4x4 Transfer Case (All Wheel Drive)

CAUTION

Operation of the vehicle in all wheel drive mode increases the wear on the driveline components, tires, and axles. Avoid engaging the front axle drive except in slippery or off-road conditions, or premature component wear may result.

Use extreme caution when backing up a steep grade while the front drive axle is engaged. Weight transfer from the rear axle to the front axle can cause overloading of the front drive gear and component damage may result.

Most Pierce Custom Chassis with all wheel drive use a power-divider rear axle with integral transfer case. Torque to the front axle is delivered via a clutched differential. The front drive axle can be engaged or disengaged while the vehicle is in motion.

To Engage Front Axle Drive

1. Reduce vehicle speed to less than 50 mph.
2. Ensure that rear wheels are not spinning faster than the front wheels and that the steering wheel is centered.
3. Remove foot pressure from the accelerator pedal and allow vehicle to coast.
4. Shift engagement switch.
5. Proceed with caution.

To Disengage Front Axle Drive

1. Remove foot pressure from the accelerator pedal and allow vehicle to coast.
2. Shift engagement switch.
3. Proceed with caution.

5-26.5 4x4 (All Wheel Drive) and Two-Speed Axle Combination

On certain chassis models a 4x4 option is offered in conjunction with a two-speed rear axle option. This configuration is provided for those departments that require maximum grade climbing ability and 4x4 operation, while still desiring normal highway speed capability. This configuration provides an interlock so that the 4x4 mode is available only when the two-speed axle is in low range. Follow the same instructions for shifting into and out of 4x4 mode as outlined above, but be sure that the two-speed axle is in low range.

5-26.6 Power Take-Off Control

WARNING

During extremely cold weather, hot-shift PTO clutches may momentarily transmit power even though they are disengaged. Never operate the engine with personnel in the vicinity of any driveshaft as it may engage without warning. Hands, clothes, hair, etc., can get caught on spinning shafts and U-joints. Failure to heed this warning may lead to personal injury or death.

Engage Power Take-Off (PTO) operated accessories with engine at idle speed.

Refer to the Power Take-Off Operation section of the Allison Transmission Operator's Manual for additional operation instructions.

5-27. Axles

5-27.1 No Spin Differential (*Optional*)

A No-Spin differential powers both wheels, yet freely permits wheel speed differentiation when required. Prime functions:

- Assures 100% of the available torque and increases drawbar pull;
- Prevents wheel spin and power loss when one wheel loses traction;
- Compensates for differences in wheel travel when turning or operating on uneven surfaces.

As long as the vehicle is operated in a straight forward or reverse direction over a smooth surface, the No-Spin differential allows the vehicle to perform as if the axle half-shafts had been welded - the axle is completely locked. This means both wheels turn at the same speed. If one wheel loses traction or leaves the ground, the opposite wheel, which still has traction, continues to drive the vehicle until traction is regained by both wheels. There can be no one wheel spinout.

When the vehicle turns a corner, or when one wheel passes over an obstruction, the outside wheel, or the wheel passing over the obstruction, must travel a greater distance and therefore faster than the other wheel. When this occurs, the No-Spin differential automatically allows for the necessary difference in wheel speed.

⚠ WARNING

Use extreme caution when accelerating or decelerating on slippery or unstable surfaces. Vehicles/axles equipped with No-Slip traction differentials are inherently more sensitive to side-slip. Loss of steering control can cause a crash that will injure or kill.

- **Distribute the load evenly side-to-side;**
- **Do NOT exceed the vehicle's rated payload capacity;**
- **Keep the diameter of the tires equal.**

Failure to observe these measures can create a difference in individual wheel speeds which can cause the No-Spin differential to deliver power to only one side of the vehicle and thus cause steering problems. Loss of steering control can cause a crash that will injure or kill.

Turn the engine off and raise all driving wheels of a No-Spin differential equipped axle when changing tires to prevent the vehicle from moving.

Axles equipped with No-Spin differentials deliver power to both wheels - even when only one wheel is on the ground. Vehicle will move if power is applied. Moving vehicle during maintenance work may injure or kill.

Operate in low gear under power rather than coasting downhill into a turn.

Braking capacity is reduced when a No-Spin differential equipped vehicle makes a turn while coasting downhill. Reduced braking capacity can cause a crash that will injure or kill.

IMPORTANT: Read the No-Spin differential operation and service manual provided by the axle manufacturer for further information and safety instructions. Additional copies may be obtained from the manufacturer, their website, or by contacting Pierce Customer Service.

5-27.2 Meritor Driver Controlled Differential Lock (DCDL) (*Optional*)

CAUTION

When DCDL is engaged, an “understeer” condition can occur when making turns, so operate the vehicle carefully. When you disengage DCDL, normal steering resumes.

If the vehicle is equipped with DCDL:

- Engage DCDL only under poor road conditions.
- Do not engage during downhill operation.
- Do not engage DCDL or operate the vehicle at speeds above 25 mph.

5-27.3 Dana Drive Axle Wheel Differential Lock (*Optional*)

CAUTION

Engage Wheel Differential Lock **ONLY** when vehicle is stationary, or moving without wheel slippage.

To engage:

1. Flip the control lever to the LOCK position, either while the vehicle is stationary, or while moving at a steady speed under 25 mph without the wheels slipping (spin out).
2. Let up momentarily on the accelerator pedal to relieve torque on the gearing and fully engage the clutch.
3. When the differential lock is engaged, the indicator light will be ON, or an audible signal will sound.
4. When the differential lock is engaged, the vehicle will understeer, requiring a longer turning radius for a given turn.

To disengage:

1. To disengage the Wheel Differential Lock, flip the control lever to UNLOCK.
2. Let up momentarily on the accelerator pedal to relieve torque and allow the clutch to disengage.
3. When the differential lock is disengaged, the indicator light and/or audible signal will go out.

5-27.4 Inter Axle Differential (IAD) Lock (Tandem Axles)

CAUTION

Lock the Inter Axle Differential **only** when stopped or moving at a slow speed. Never attempt to lock the Inter Axle Differential while the rear wheels are spinning as this may cause shock damage to the axle components and result in costly repairs.

Never shift a two-speed tandem axle from one range to another with the IAD in the LOCKED position. This may cause shock damage to axle components and result in costly repairs.

The inter-axle differential provides for necessary differential action between the axles of a tandem drive unit. This allows the wheels of either axle to revolve faster or slower than the wheels of the other axle in order to compensate for cornering, uneven road surfaces, and slightly different tire sizes. When encountering soft or slippery road conditions, the IAD can be locked out, eliminating any differential action between the axles.

OPERATION

Lock the inter-axle differential and achieve maximum pulling power when approaching slippery or poor road conditions.

After engaging the IAD Lock switch and proceeding at a slow, even speed, let up momentarily on the accelerator pedal to allow the lock to engage. Proceed over the poor road conditions cautiously.

Once road conditions have improved, move the IAD Lock switch to the UNLOCK position while maintaining vehicle speed. Let up momentarily on the accelerator to allow the lock to disengage. Resume driving at normal speed.

5-27.5 Oshkosh® TAK-4® Rear Axles

5-27.5a TAK-4 T3 Rear Steering Operation

WARNING

Oshkosh TAK-4® T3 rear steering axles do not track the same way as standard or conventional axles. Wide, conventional turns may cause the rear end to swing beyond a “normal” or standard turning radius. Operators must know and understand the differences in driving technique prior to operating vehicles equipped with TAK-4 T3 axles.

Figure 5-3: TAK-4 T3 Steering

TAK-4 T3 REAR-STEERING AXLE STEERS COORDINATED, OR OPPOSITE OF FRONT AXLE



REAR OF VEHICLE SWINGS SLIGHTLY TO ACCOMPLISH OVERALL TIGHTER TURNING RADIUS

1590

The Oshkosh TAK-4® rear axles equipped with (optional) T3 (Total Turning Technology) rear-steering system are designed to more closely follow the path of the front axle when compared to a non-steering rear axle(s). This is accomplished by the rear axle(s) steering in a coordinated mode, or opposite the front axle. This allows the vehicle to make a tighter turning radius overall. However, this will also cause the rear of the vehicle to swing out farther than one equipped with conventional rear axle(s).

The rear axle(s) follow the steering angle of the front axle, although to a lesser degree. Therefore, making a wider conventional turn with a greater steering angle will result in the rear axle(s) steering with a greater angle and swinging out farther than the operator may intend.

- Left and right turns should be taken tighter than conventional apparatus.
- Set up for the turn slightly to the inside of the center of the lane, and follow through the turn closer to the inside than with a conventional apparatus.
- When turning, drive the vehicle judging that the rear axle(s) will follow. This can prevent the rear of the vehicle from running over the curb or into oncoming lanes or obstacles.

5-27.5b TAK-4 Differential Lock Operation

CAUTION

DO NOT operate the vehicle on dry pavement with the differential lock engaged.

Attempting to operate the vehicle on dry pavement with the differential lock engaged WILL result in damage to the steering system and/or the differential(s).

Under no conditions should the differential locking system be engaged when any wheel is spinning. This could only result in severe mechanical damage to the drive train.

It may be necessary to slowly back up in order to disengage the system if excessive driveline windup has occurred.

Before entering an area where poor traction conditions are likely to occur, engage driveline differential locking system prior to wheel slippage as follows:

1. Engage switch on dash panel. Let up on the accelerator to provide an interruption in drive torque to expedite shift. The differential lock warning light will illuminate to indicate the differential lock system has been engaged.

NOTE: Always unlock the differentials after passing adverse conditions. This permits the driveline to compensate for differences in turning distances for each wheel and allows maximum performance and speed.

2. After regaining normal traction, let up on the accelerator; then disengage switch.

5-27.6 Two-Speed Rear Axle

The two-speed rear axle switch permits selection of either the high or low axle ratio.

Downshift Move selector switch to low. Release and depress the accelerator quickly.

Upshift Move the selector switch to the high range with the accelerator depressed. Release the accelerator and pause until the shift is complete.

5-28. Brakes

⚠ WARNING

Brakes and brake systems must be maintained and adjusted properly. Failure to properly maintain or adjust the brakes can lead to reduced brake performance, property damage, or personal injury.

5-28.1 Downhill Operation or Heavy Braking

Always rely on the braking effect of the engine, engine brake, exhaust brake, or retarder when descending a grade or when anticipating frequent heavy deceleration. If service brakes alone are used to control vehicle speed, excess heat may be developed causing brake fade. Brake fade occurs when the brake drums become hot and expand away from the brake shoes and the stroke of the slack adjusters become less effective. If service brakes are required to supplement retardation, apply the brakes in short durations of 5 to 10 seconds rather than a continuous application. This will minimize heat buildup and reduce the possibility of brake fade.

The brake lining material used on Pierce Custom Chassis has been selected in conjunction with the axle manufacturers to provide the best balance of stopping distance performance, grade holding capacity, and lining life. Brake lining life is dependent on the type of service to which the vehicle is subjected and is heavily influenced by driving habits.

5-28.2 Air Pressure Gauge, Indicator Light, and Audible Alarm

⚠ WARNING

The quick buildup feature allows the vehicle to be driven even though the front brake section may not have sufficient air pressure to enable sustained or full force braking. Use extreme caution when operating the vehicle with either air brake section charged to less than 60 psi, or property damage or personal injury could result.

The air pressure gauges indicate the amount of pressure in each section of the split air brake system. The indicator light will light and the alarm will sound any time the ignition switch is set to the run position and the pressure in either section is less than approximately 60 psi.

The quick buildup feature allows the pressure to be built up in the rear brake section first to enable release of the parking brakes before the pressure in the front section is adequately charged. This is a feature unique to the fire apparatus industry and is part of the NFPA recommendations. This feature is meant to allow the vehicle to be driven as soon as possible in the event of an emergency response.

5-28.3 Antilock Braking System (ABS)

⚠ WARNING

ABS cannot provide more braking performance than the road conditions will permit. Reduce speed during slippery conditions, or serious injury or death may result.

The antilock braking system automatically applies and releases the brakes during low traction or panic brake applications to minimize the stopping distance and improve steering control. ABS will prevent wheel lock-up at all times. Push the pedal steadily (do not pump brakes) until the vehicle speed has been reduced to the desired level.

5-28.4 Traction Control (Optional)

Automatic Traction Control (ATC) is an optional feature of the ABS system. ATC operates in two ways:

- It applies the service brake to a spinning wheel so that the torque can be transferred through the differential to the wheel that has the traction.
- It reduces engine torque when both wheels are spinning to improve traction.

The ATC light located in the cab will light when the ATC feature is active.

A traction control switch is provided with the ATC option. This function increases available traction on extra soft surfaces like snow, mud, or gravel by slightly increasing the permissible wheel spin. When this feature is selected, the ATC indicator light will blink continuously.

NOTE: For 4x4 vehicles with Electronic Stability Control (ESC), the ATC system is only active in 4x4 mode. Refer to [Table 5-7](#) for additional information.

Table 5-7: ATC Light Operation - 4x4 Chassis with ESC

Mode	ATC Light	ATC Status	ESC Status
4x2	ON	OFF	ON
4x4	OFF; flashes when system is active	ON	ON

5-28.5 Parking Brakes

WARNING

Uncontrolled Vehicle Hazard

Never park vehicle on a steep grade.

Before leaving driver seat ALWAYS:

- **Set parking brake.**
- **Turn front wheels in the direction of the curb.**

Immediately after leaving the driver seat:

- **Block wheels with adequate wheel chocks.**

Failure to follow these procedures may lead to loss of vehicle control, property damage, personal injury, or death.

All Pierce Custom Chassis are equipped with spring brakes on the rear axles for parking. The spring brakes are applied by operation of the yellow parking brake valve. These brakes are intended to hold the vehicle in a parked position or to assist in bringing it to an emergency stop and should not be used for normal driving.

If air pressure is lost in the rear service brake section, the spring brakes will be modulated by pressure from the front brake section allowing a few brake applications before the spring brakes are automatically applied. If air pressure is reduced to approximately 40 psi in both systems, the spring brake valve will automatically apply.

5-28.6 Manual Parking Brake Release (Caging Brakes)

⚠ WARNING

Caged Brakes Will Not Hold Vehicle.

Never leave a vehicle with caged brakes unattended.

- **Park vehicle on a flat surface only.**
- **Chock wheels in both directions.**
- **Perform Lockout/Tagout to secure vehicle and make sure no one drives it until repairs are complete.**

Failure to follow these procedures may lead to loss of vehicle control, property damage, personal injury or death.

To avoid the loss of vehicle control resulting in property damage or personal injury, block the wheels of the vehicle to prevent motion before attempting to manually release spring brake chambers.

Never attempt to disassemble a spring brake chamber as the release of a powerful spring could result in severe personal injury or death.

Spring brake chambers require air pressure to release. If sufficient pressure is not available and the vehicle must be towed, the spring brakes can be manually released or “caged.”

To manually release the spring brake chambers, use the caging stud supplied with the spring brake chamber. Insert the stud into the chamber and turn to engage the stud in the slots. Tighten the nut on the caging stud with a wrench to compress the spring and release the brake. After the need for caging the brakes has past, charge the spring brake chambers with air pressure and remove the caging stud.

5-28.7 Emergency Parking Brake Release (Optional)

⚠ WARNING

The emergency parking brake release feature allows the vehicle to be driven even though service brakes may not have sufficient air pressure to enable sustained or full force braking. Never exceed 2 mph with the emergency parking brake release engaged and use extreme caution when operating the vehicle with either air brake section charged to less than 60 psi, or property damage or personal injury could result.

The emergency parking brake release option allows the operator to override the parking brake safety feature that prevents the spring brakes from being released until minimum pressure has been built up in the air brake system. Air pressure for the spring brake release is supplied by a dedicated air tank.

5-28.8 Auxiliary Front Wheel Lock (*Optional*)

▲ WARNING

The auxiliary front wheel lock feature uses air brake system pressure to keep the front brakes applied. It should be used only with the engine running and a qualified attendant present at all times. It is a supplemental brake only, which does not meet the FMVSS parking brake criteria and must be used in conjunction with the yellow parking brake valve when parking the vehicle. Failure to follow these precautions could lead to loss of vehicle control causing property damage, serious personal injury, or death.

The auxiliary front wheel lock feature allows the operator to engage the service brakes on the front axle to gain additional grade holding capability, or to improve stability when the aerial device outriggers raise the rear wheels off the ground. The parking brake must be engaged before the auxiliary front wheel lock will function.

5-28.9 Air Reservoir Moisture Draining

Collection of moisture in the air reservoirs due to condensation is normal even though the vehicle is equipped with an air dryer. Open the petcocks on each air tank to drain the condensate.

5-28.10 Air Dryer

Every Pierce Custom Chassis is equipped with an air dryer that removes moisture and contaminants from the pressurized air which comes from the engine-mounted compressor before it reaches the air reservoirs. Moisture is collected on the surface of desiccant pellets and is discharged out the bottom of the air dryer each time the governor unloads.

5-28.11 Grade Holding and Brake Burnishing

▲ WARNING

The capability of the vehicle to hold on a specific grade may decrease temporarily whenever new friction material is installed. Use wheel chocks when parking on a grade to avoid loss of vehicle control resulting in possible property damage, personal injury, or death.

The ability of the vehicle to park downhill or uphill is affected by the conformity of the friction material to the brake drum or rotor. This conformity improves through the natural burnishing action of brake applications during the early life of the vehicle. The ability of the vehicle to hold on a specific grade is determined after the brakes have been fully burnished. See "[Brake Burnishing](#)" on [page 3-5](#) for additional information.

5-29. Auxiliary Braking System

⚠ WARNING

The use of any compression brake or exhaust brake systems during slippery road conditions or inclement weather may cause rear wheel lock-up and loss of vehicle control, resulting in property damage, personal injury, or death.

An Auxiliary Brake System provides braking torque through the driveline to the rear wheels. The use of an auxiliary brake reduces brake wear, reduces brake heat buildup, and can help to minimize the occurrence of brake fade during heavy or frequent braking.

An Electronic Control Unit (ECU) in the Antilock Braking System (ABS) monitors the wheels and turns off the auxiliary brake if it senses that the wheels are not spinning at the same speed. The ABS ECU does not know to turn off the auxiliary brake until an ABS event has already occurred. In the split second between the ABS sensing the skid and the time it takes for the auxiliary brake to shut off, there may be a skid initiated. For this reason, Pierce Manufacturing recommends turning off the Auxiliary Brake System during slippery conditions.

5-29.1 Compression Brake

The compression brake (Jake Brake[®] or equivalent) is an electronically actuated mechanical system added to the engine valve train. When activated, the compression brake alters the operation of the engine's exhaust valves so that the engine works as a power-absorbing air compressor.

5-29.2 Exhaust Brake

The exhaust brake (Extarder[®], Blue-Ox[®], or equivalent) consists of a flapper valve installed in the exhaust pipe between the engine and the muffler. When activated, the flapper restricts the passage of the exhaust gases and increases the back pressure in the cylinders during the exhaust stroke. This increases the natural retardation effect of the engine. Braking torque at the wheels will vary depending on the transmission range selected.

5-29.3 Electromagnetic Retarder

The electromagnetic retarder (Telma[®] or equivalent) may be mounted in the driveline or attached directly to the rear axle. When activated, electrical power is supplied to a series of coils in the retarder that create an electromagnetic field. This field inhibits the rotation of the rotor and creates a braking torque at the rear wheels. Various options allow the retarder to be applied in stages either manually or by combinations of brake and accelerator pedal settings. Heat generated by the retardation effect is dissipated by cooling fins on the retarder.

5-29.4 Hydraulic Retarder

CAUTION

Observe the following cautions when driving a vehicle equipped with a hydraulic retarder.

Apply and operate the retarder only when the engine is at closed throttle.

Observe transmission and engine temperature limits at all times. Select the lowest possible transmission range to increase the cooling system capacity and total retardation available.

In the event of overheating, decrease the use of the retarder; use service brakes.

Observe the retarder “over-temp” light to ensure that the vehicle control system is functioning properly.

Refer to the Allison Transmission operator’s manual for additional cautions.

The hydraulic retarder (Allison[®] Transmission Retarder or equivalent) uses the viscous property of transmission fluid to retard the driveline. When activated, transmission fluid is introduced into the retarder housing and energy is absorbed into the fluid through the opposing action of spinning vanes. This retards the vehicle through the rear wheels and adds heat to the transmission fluid. This heat is dissipated through the transmission cooler and radiator.

Retarder Brake Capacity

The maximum braking capacity of Allison retarders is determined by the transmission Electronic Control Unit (ECU) calibration. This capacity is specified at the time of purchase to provide the low, medium, or high capacity setting. This capacity setting indicates the maximum retardation force with the system fully applied. Low settings will provide auxiliary braking force with moderate cooling system heat loads. High settings will provide aggressive auxiliary braking, but may limit the amount of time that the retarder can be applied before exceeding the cooling capacity of the vehicle.

Control Systems

The control system may be specified in many versions. The most popular control systems are described below.

Throttle 100%	The retarder applies fully whenever the throttle pedal is released.
Throttle 50% - Brake 50%	The retarder is applied to half its capacity when the throttle pedal is released, and applied to its full capacity when the brake pedal is depressed.
Throttle 33% - Brake 67%	The retarder is applied to one third its capacity when the throttle pedal is released, and applied to its full capacity when the brake pedal is depressed.
Hand Lever Control	The retarder is applied when the throttle pedal is released. The percent of application is controlled by a six-position hand lever.
Foot Pedal	The retarder is applied when a dedicated foot pedal is depressed. Retardation force increases proportionally as the pedal is depressed farther.

Overheat Warnings

Because the retardation force is created by the churning action of transmission fluid within the retarder housing, a significant amount of waste heat is generated. This heat is transferred to the radiator coolant via a shell and tube heat exchanger. The radiator is thus ultimately required to dissipate heat generated both during vehicle acceleration (engine and transmission heat load) and during braking (retarder heat load). During heavy use and high ambient

temperatures, the extra heat load created by the retarder may exceed the rate at which the cooling system can dissipate the transmission fluid heat load (at the shell and tube cooler) or the total heat load (at the radiator). **The vehicle operator must observe the transmission temperature gauge & warning lights and reduce retarder use if the transmission fluid temperature climbs too high.**

When the cooling system capacity is exceeded, the transmission ECU will begin to cut back on the retardation output to limit the degree of overheating, but not before the system temperatures have peaked beyond the normal operating range. The warning light in the center of the instrument panel will illuminate and an alarm will sound when the transmission output temperature exceeds 330°F, or if the transmission sump temperature exceeds 250°F. A warning light adjacent to the transmission temperature gauge will illuminate and an alarm will sound if the gauge reading exceeds 335°F. This provides a redundant warning to the operator that the critical temperatures have been exceeded.

If the transmission high temperature warning light is illuminated, the transmission ECU will change the shift sequence to hold the transmission in gear longer, effectively increasing the rpm of the engine. This increases the speed of the cooling fan and water pump, which will increase the heat transfer rate of the cooling system and thereby hasten the return of the transmission sump temperature to within the normal operating range.

Operation in High Ambient Temperature Conditions

The influence of retarder use on the cooling system temperatures will vary with the retarder capacity and the control system options. The higher capacity settings produce higher amounts of heat. Control systems that apply 50 to 100 percent of the retarder as the throttle pedal is released produce the heaviest heat load. Frequent cycling on and off the throttle pedal builds up heat rapidly even though the situation may not require braking effort. If constant use of the retarder produces frequent overheat situations, consult your Pierce Dealer regarding a change to the control system or capacity setting that will better suit your duty cycle and environmental conditions.

5-30. Stability Control (Optional)

5-30.1 Safe Vehicle Operation



Note that RSC and ESC systems cannot prevent accidents and/or loss of control of the vehicle. RSC and ESC systems are not a reason to take unnecessary risks. A driver can still exceed the physical limitations of the system with either excess speed and/or extreme cornering, causing a loss of directional control or roll over. Training is recommended when using either system.

When operating your vehicle, always use safe driving techniques. The driver is ALWAYS the most important part of a safe vehicle operation.

5-30.2 Roll Stability Control (RSC)

Roll Stability Control (RSC) is an Anti-Lock Braking System (ABS) based system that senses when impending rollover conditions occur, and if detected, intervenes in the operation of the truck by automatically reducing the vehicle speed. All measuring and processing needed to calculate, and continuously update, the rollover risk is done within the ABS Electronic Control Unit (ECU).

RSC is automatic. It becomes active when the ECU senses lateral acceleration that exceeds thresholds. It then attempts to quickly reduce vehicle speed until the lateral acceleration falls below the determined threshold.

The type and magnitude of an RSC intervention depends on the amount that the actual vehicle lateral acceleration exceeds the control limit. Intervention starts with an engine torque reduction command (you may sense a decrease in engine power), followed by application of the engine brake (*if the vehicle has an engine brake, you will feel the additional deceleration*), and if necessary, application of the drive axle brakes (you will feel braking take place).

For additional RSC information, refer to the Pierce Service Manual, group 0251-V-015, Meritor Wabco Anti-Lock Braking System (ABS) and group 0995-V-003, Meritor Roll Stability Control (RSC) Driver Tips.

5-30.3 Electronic Stability Control (ESC)

▲ WARNING

Electronic Stability Control (ESC) is an electronic system designed to help the driver maintain vehicle control under adverse conditions. It is not a substitute for safe driving practices. Electronic stability control is only a driving aid; all normal precautions for driving in inclement weather and on slippery road surfaces must be observed. There is NO substitute for the Safe Driver

Never drive too fast for the road conditions or too quickly when cornering. Electronic stability control (ESC) will not prevent accidents. Excessive speed in turns, abrupt maneuvers, and hydroplaning on wet surfaces, and driving onto soft shoulders can still result in serious accidents. Only a safe and attentive driver can prevent accidents by avoiding maneuvers that cause the vehicle to lose traction. Even with the ESC installed, always follow all the normal precautions for driving - including driving at safe speeds for the conditions.

Electronic Stability Control (ESC) is designed to stabilize the vehicle during cornering maneuvers. ESC checks where you are steering and where the vehicle is actually going. ESC applies the brakes at individual wheels and intervenes in the engine management system to help point the vehicle in the direction that you are steering.

During normal driving, ESC works in the background and continuously monitors steering and vehicle direction. It compares the driver's intended direction (determined through the measured steering wheel angle) to the vehicle's actual direction (determined through measured lateral acceleration, vehicle rotation (yaw), and individual road wheel speeds).

ESC intervenes only when it detects loss of steering control, i.e. when the vehicle is not going where the driver is steering. This may happen, for example, when skidding during emergency evasive swerves, understeer or oversteer during poorly judged turns on slippery roads, or hydroplaning. ESC estimates the direction of the skid, and then applies the brakes to individual wheels asymmetrically in order to create torque about the vehicle's vertical axis, opposing the skid and bringing the vehicle back in line with the driver's commanded direction. Additionally, the system may reduce engine power or operate the transmission to slow the vehicle down.

ESC can work on any surface, from dry pavement to frozen lakes. It reacts to and corrects skidding much faster and more effectively than the typical human driver, often before the driver is even aware of any imminent loss of control.

It is important to understand that ESC is not a performance enhancement nor a replacement for safe driving practices, but rather a safety technology to assist the driver in recovering from dangerous situations. ESC does not increase traction, so it does not enable faster cornering. More generally, ESC works within the inherent limits of the vehicle's handling and available traction between the tires and road. A reckless maneuver can still exceed these limits, resulting in loss of control. For example, in a severe hydroplaning scenario, the wheels that ESC would use to correct a skid may not even initially be in contact with the road, reducing its effectiveness.

5-30.3a ESC Brake Noise

When ESC is operating you may hear air brake pulsations and feel engine power reduction during aggressive maneuvers. These are normal conditions that indicate the system is working to improve stability control.

5-30.3b ESC Malfunction Indication

ESC malfunctions trigger the ATC indicator light which will come on briefly when starting your vehicle. If the ATC indicator light stays on while driving, pull to the side of the road in a safe area and re-start the engine. If the light still stays on while driving, have the vehicle inspected by your dealer mechanic. Without ESC your vehicle will have normal braking and cornering ability, but it will not have the added stability control that ESC provides.

5-31. Steering

⚠ WARNING

Do not adjust the steering column with the vehicle in motion to avoid uncontrolled steering inputs that could lead to property damage, personal injury, or death.

IMPORTANT: Pay attention to the feel of the steering system during driving. Check for looseness, pulling, strange noises, etc. Any change in the feel should be investigated by a qualified mechanic.

5-31.1 Steering Column Adjustment

Adjust the tilt of the steering column by pulling up on the adjusting lever while tilting the column to the desired position. Adjust the height of the steering wheel by pushing down on the adjustment lever and moving the wheel to the desired position.

5-32. Tire Chains

5-32.1 Chain Clearance

Front Tires

⚠ WARNING

Installation of tire chains on the front tires may cause extensive damage to the cab as well as safety critical parts of the steering and brake systems. Damage to these components may lead to serious injury or death.

Pierce Custom Chassis do not provide clearance for tire chain installation on the front tires.

Rear Tires

Installation of chains on the rear tires may be possible depending on the chassis model, tire size, suspension type, and body style. Before installing chains on rear tires, ensure that adequate clearance exists between the tire and fender liner at full axle jounce.

Single Rear Axle			
Configuration / Chassis	Tires	Automatic Tire Chains	Wrap-Around Tire Chains
			Application
26,000 lb. GAWR	445	On-Spot	
			Not Available

Tandem Rear Axle			
Configuration / Chassis	Tires	Automatic Tire Chains	Wrap-Around Tire Chains
			Application
36,000 lb. GAWR	385	On-Spot	
			Available
48,000 lb & 52,000 lb GAWR	445	On-Spot	
			Not Available

5-32.2 Automatic Tire Chains

Automatic tire chains are designed to provide additional traction during slippery conditions at slow vehicle speeds only. Do not operate vehicle with automatic tire chains engaged at speeds over 35 mph.

- On trucks equipped with Command Zone™ D-Series modules (*Arrow XT™, Impel™, Quantum®, Velocity™, Dash® CF, Enforcer™*):
 - The tire chains will activate instantly if the parking brake is set and the switch is activated.
 - If the parking brake is released, the switch must be held for two seconds before the tire chains will activate (to prevent accidental activation).
- Engage automatic chains before reaching slippery conditions.
- Engage automatic chains while traveling at vehicle speeds between 2 and 25 mph.
- Vehicle can be stopped and started again as long as the control switch remains in the engaged position.
- Disengage automatic chains while traveling at vehicle speeds between 2 and 35 mph.
- To engage chains when the vehicle is already stuck, spin tires up to 5 mph and engage chains. Stop spinning the tires and proceed slowly once the action of the chains is apparent.
- On trucks equipped with All Steer® all-wheel steering (AWS), the AWS system monitors the system and prevents the engagement of the tire chains in those conditions where the chains could damage the body or other components.

Refer to the chain system manufacturer's instructions for maintenance and service requirements.

5-33. Tire Pressure Management System

5-33.1 Tire Pressure Management (*Standard*)

NOTE: The tire must be inflated to the correct pressure before installing the tire sensor valve cap to calibrate and ensure proper operation.

Your apparatus is equipped with a LED Air Guard™ tire alert pressure management system that will monitor the pressure of each tire. The LED Air Guard™ valve cap is a chrome plated brass sensor that is installed on the valve stem of each tire. This sensor will calibrate to the tire pressure when first installed on the valve stem.

The sensor can be checked for functionality and battery condition by simply unscrewing the cap. If it is in working condition, the LED will immediately start blinking. The sensor will activate an integral battery operated LED when the pressure of that tire drops 8 psi.

See “LED Air Guard Tire Pressure Monitoring System”, Group 0670-V-003 in the vehicle Service Manual for more information.

5-33.2 Tire Pressure Management (*Optional*)

Your apparatus may be equipped with a SMARTIRE tire pressure management system that will monitor each tires pressure and temperature. A 2.00" gauge located in the cab instrument panel will indicate each tires position, pressure and temperature. An alarm will sound when the tire pressure deviates 10% or more. A wireless sensor is mounted to each wheel.

The system has three (3) alert levels:

- Critical Low Pressure Alert
- Pressure Deviation Alert
- High Temperature Alert

Each alert will trigger an audible alarm and an indicator light within the gauge to signal the driver of the problem.



Cab

6-1. Cab Tilt System

6-1.1 Cold Weather Operation

Cab lift cylinders on all Pierce Custom Chassis tilt cabs include a velocity fuse in the tilt system. This is a safety device designed to lock fluid in the cylinders in the event that pressure is lost suddenly due to pump failure or a broken line. The velocity fuse becomes more sensitive to actuation at low temperatures. To avoid the possibility of locking up the cylinders when lifting the cab in extreme cold weather, replace the fluid in the cab lift system as specified in [Table 6-1](#).

Table 6-1: Cab Lift Cylinder Fluid Chart

Temperature		
F	C	Fluid Type
0 to 120	-18 to 49	TES-389 approved
Below 0	Below -18	MIL-H-5606 (Mobil HFA or Equivalent)

Purge all air from the cab tilt system whenever replacing fluid.

6-2. Doors and Windows

6-2.1 Latches and Window Regulators

Door latches and window regulators require lubrication to reduce component wear and continue to operate smoothly. To ensure smooth operation, remove the door panel and lubricate all moving parts on latches, paddle handles, linkages, and regulators. The door latch mechanism requires specific attention and needs to be lubricated. Liberally apply white lithium grease or Alpha 2000 grease between the pivot arm (cam shaped lever) and the pivot plate of the door latch. Operate the regulator and lubricate all moving parts until the lubricant is distributed evenly.

6-2.2 Door Strikers

Inspect the door latch strikers. Tighten loose strikers on cab side doors to 55 ft-lbs. Adjust the striker in or out to obtain an even seal around the door with the latch closed completely. If the striker must be adjusted downward to line up with the latch, inspect the door hinge for damage or wear. To ensure smooth operation, avoid excessive seal compression that will require high opening forces at the paddle handle.

6-2.3 Hinges

IMPORTANT: Door hinges should be lubricated by spraying them with a light coating of silicone lubricant. After spraying, clean over-spray from surrounding painted surfaces and walk areas.

Inspect hinge fasteners. Tighten loose hinge fasteners as required. Inspect the hinge for wear or damage. Hinges can be “sprung” from the weight of crewmembers supporting themselves on the doors during entry. This will cause the door to sag and bind on the striker. Replace sprung hinges to ensure smooth door operation.

6-2.4 Weatherstrip

Inspect weatherstrip for tears or excessive abrasion. To extend life of rubber, spray weatherstrip and window rubber with a light coating of silicone lubricant. Clean over-spray from surrounding painted surfaces, glass, and walk areas.

6-3. Wiper Blades

Inspect wiper blades to ensure proper clearing of the windshield. Wipe the blades with a clean towel soaked in windshield washer fluid. If this does not remedy wiper blade problems such as chatter and streaking, then the blades should be replaced.

6-4. Heating, Ventilation, Air Conditioning (HVAC)

6-4.1 Heater Shut-Off (*Optional*)

 **WARNING**

Use of the heater shut-off valve will prevent warm air from circulating through the defroster system and may lead to a reduced ability to clear humidity from the windshield and subsequent reduced driver visibility.

Close heater line valves during warm weather to eliminate the warming affect of heater coils by slow leakage past the control valve.

6-4.2 Air Conditioning (Optional)

⚠ WARNING

Use only refrigerants approved by Pierce Manufacturing for your air conditioning system. Some unapproved refrigerants are flammable and can explode, causing injury to personnel. Other unapproved refrigerant can cause the system to fail, requiring costly repairs.

The air conditioning system contains refrigerant under high pressure. To avoid risk of personal injury or damage to the system, adding refrigerant or any repair requiring lines to be disconnected should be done by a certified repairman.

⚠ CAUTION

Air conditioning system contains R134A:

- Avoid breathing refrigerant and lubricant vapor or mist;
- Exposure may irritate eyes, nose and throat;
- To remove R134A from air conditioning system, use equipment certified to meet SAE J2210;
- If R134A discharge occurs, ventilate work area before resuming service;
- Additional health and safety information may be obtained from refrigerant and lubricant manufacturers.

Do not operate the air conditioning with the cab up.

The cab should not be raised until the air conditioner has been shut-off and the truck has sat with the battery switch ON for at least 30 minutes. This will allow the water to be pumped out of the air conditioner unit. Failure to do so will result in water condensation dripping out through the openings in the evaporator cover when the cab is lowered after service.

NOTE: Do not add refrigerant unless the system is checked for leaks and any leaks found are repaired.

The air conditioning system should be checked at the start of the warm weather season. The service should include cleaning of the condenser fins and a refrigerant level check. Charge requirements for the system can be found on a tag on the rear unit. Drive belt tension should also be checked at this time. Some units will have air intake filters. This filter must be replaced if it becomes dirty. Condition of the filter will be based on conditions and use. Overhead units have a drain pan and hoses to direct condensed water to the outside of the vehicle. Clean the pan and make sure hoses are not blocked. The pan may have a foam pad that prevents water from sloshing. Replace the pad as necessary. Inspect all vents for looseness and operation. Replace if necessary.

6-4.2a Air Conditioning Sight Glass

Figure 6-1: Sight Glass Conditions

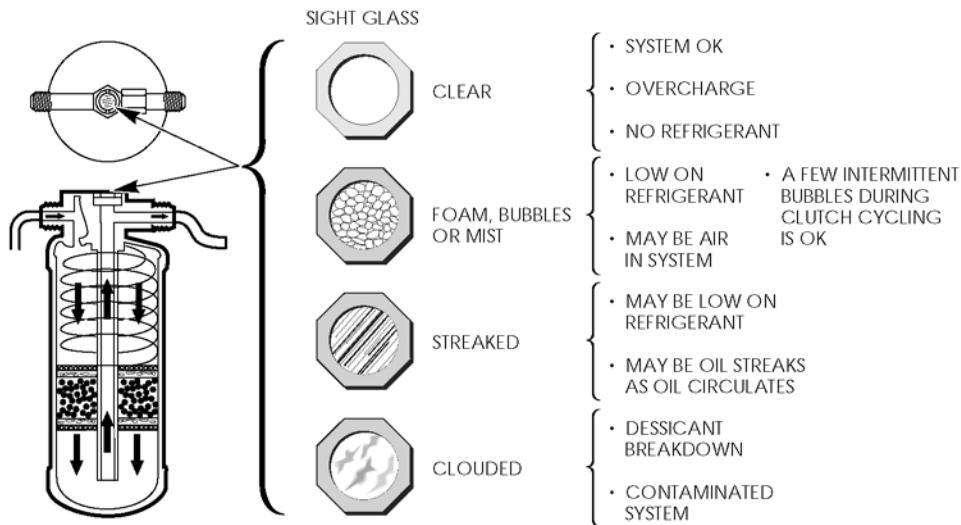

1115

The sight glass is the only point where you can actually see inside the air conditioner during operation. Check the sight glass through the window on top of the receiver-drier (or the separate in-line sight glass). If the system is functioning properly and cooling the cab adequately, the sight glass should be clear (you will not see anything in it). If it is not clear when the system is first turned on, wait a few minutes for the system to stabilize, then look again. *Figure 6-1* illustrates and explains what you may observe in the sight glass. Roof mounted condenser fans may run continuously or cycle on and off. If you can't tell by sound, you may have to climb a ladder and observe the fan blades.

6-4.2b Refrigerant Recovery and Recycling

Your Pierce Custom Chassis uses environmentally acceptable refrigerant. R-134a Air Conditioning Refrigerant is a hydrofluorocarbon (HFC) that is endorsed by the Environmental Protection Agency (EPA) and is an ozone-saving product. However, Pierce Manufacturing recommends that air conditioning service be performed by certified dealers or other service facilities using recovery and recycling equipment.

6-5. Safety Restraints and Devices

6-5.1 Seat Belts

WARNING

Do not bleach or dye seat belt webbing. Bleaching or dyeing may cause a severe loss of belt strength. This loss of strength could allow the seat belt to break under stress, thus resulting in personal injury.

The entire seat belt assembly should be inspected for corrosion, wear, fraying, or weak spots. The retractor, latch and buckle should be checked for proper function, and all seat belt mounting bolts should be tight at all times.

Any seat belt severely strained in a collision should be replaced before the vehicle is placed back in service.

The unique conditions of a fire service application put stress and strain on seat belt assemblies not normally seen in typical automotive applications. Webbing can be abraded by interference with door hardware, bunker gear attachments, SCBA harnesses, etc. It is important to inspect and maintain seat belt webbing to ensure that it will function properly in a crash.

To ensure occupant safety, regularly inspect the seat belts. At a minimum, the seat belts should be inspected and replaced following the criteria listed in this section. Pierce further recommends considering replacement of the belts at 5-year intervals, to reduce the potential failure of the seat belts caused by unapparent damage such as belt exposure to chemicals or UV radiation. The following photos illustrate various levels of belt damage that can occur if care is not taken.

IMPORTANT: Seat belt webbing should be inspected and replaced if anything beyond slight damage is noticed.

Figure 6-2: Examples of Seat Belt Webbing Damage

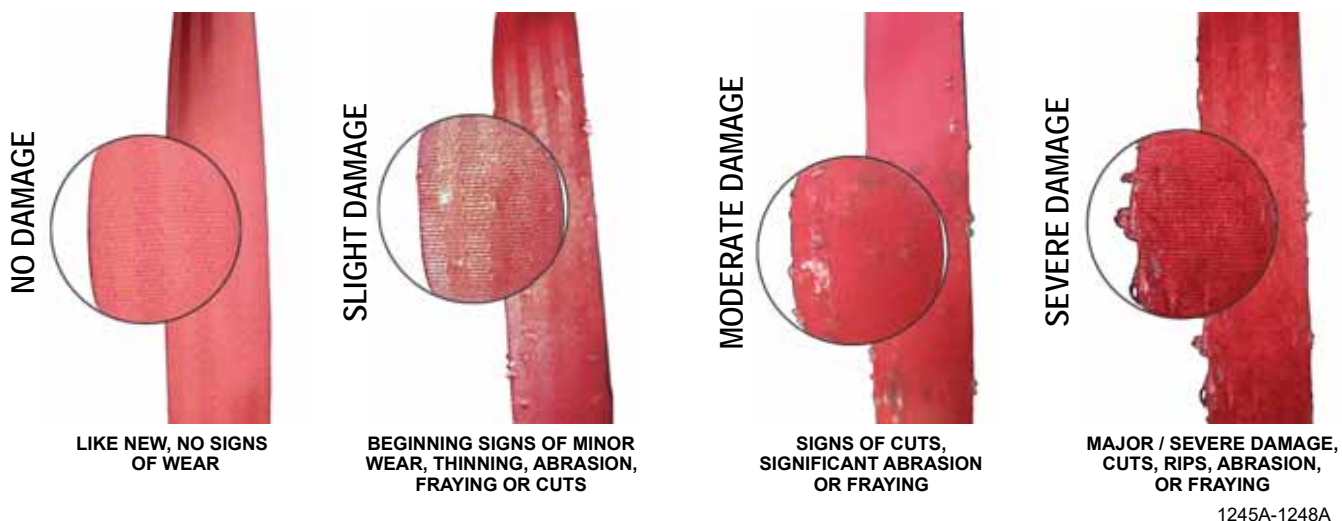

6-5.2 Side Roll Protection System (Optional)

The following WARNING and CAUTION statements must be followed when working on a vehicle equipped with the Side Roll Protection System:

WARNING

NEVER attempt to modify the Side Roll Protection System or remove system components, as injury could result. Tampering with, or removing, the roll sensor could cause an accidental deployment of the protective devices.

NEVER place any object in the deployment pathway of any Side Roll Protection component.

NEVER tamper with the wiring harnesses of any Side Roll Protection component.

CAUTION

Always follow labeled warnings and cautions on each component.

Before to welding on the vehicle, turn the vehicle power OFF. Ensure the power is removed before disconnecting or connecting the roll sensor(s). Disconnect both connectors from the master roll sensor and the slave roll sensor (if installed). When welding is completed, reconnect the connectors. Make sure the red locking tabs are latched. Refer to *“Welding Instructions”* on [page 6-40](#) for additional welding information.

The Side Roll Protection System is designed to be maintenance-free and fully functional for 20 years after installation. Service the Side Roll Protection System only if you are a Pierce authorized technician.

CAUTION

The Suspension Seat Safety System (S4S), Integrated Gas Pretensioners (IGP) / Integrated Belt Pretensioners (IBP) and Inflatable Head Curtains (IHC)/Supplemental Restraint Air Bag (SRA) must be replaced every 20 years, as measured from the date of manufacture appearing on the FMVSS information decal; See *“FMVSS Information Decal”* on [page 1-3](#). Expired devices may not provide protection in a crash.

Fault Light Information

If the Side Roll Protection fault light remains lit, or does not light during vehicle prove out, the vehicle should be brought to a Pierce Manufacturing authorized service facility. In certain cases, turning OFF the ignition and vehicle power and then turning them back ON may reset the fault light. The roll sensor(s) record all fault codes, which may be read with a diagnostic reader at a Pierce Manufacturing authorized service facility.

Precautions When Tilting the Cab During Maintenance Actions

The roll sensor(s) are programmed to allow for normal cab tilt using the cab lift system. Before to performing any maintenance activity that require tilting the cab beyond the capabilities of the cab lift system, turn OFF the vehicle power and disconnect the roll sensor(s). When the maintenance action is complete, restore the Side Roll Protection System by turning the vehicle power OFF and reconnecting the roll sensor(s) connectors, ensuring that the red locking tabs are latched.

Refer to the Pierce Service Manual, group 0010-P-020, Side Roll Protection Troubleshooting Guide; group 0845-P-001, Side Roll Protection Repair; or contact Pierce Customer Service for additional information concerning the maintenance and service of the Side Roll Protection System.

Chassis

6-6. Aerial Device Boom Support

Inspect the boom support for structural integrity. Tighten any loose fasteners to the proper torque per the Frame Fastener Torque Chart. Inspect welds for signs of fatigue cracking.

6-7. Automatic Lubrication Systems

6-7.1 Reservoir

Visually check the reservoir to ensure there is an adequate grease supply for the impending work day. If the lubricant level in the reservoir gets too low, air will be induced into the system. This will not allow pressure to build up which will cause a system fault.

6-7.2 Inspection

Inspect the vehicle for over or under lubrication before it is washed or pressure cleaned. Verify that all originally attached lubrication lines are still connected. Pay particular attention to those points closest to the road surface.

6-7.3 Condition of Lube Points

Inspect all points being lubricated. A seal of lubricant around the outside of the bushings should be visible as this assures that bearings are being flushed of contaminants. If the entire system appears to be over or under lubricated, adjust the control unit accordingly. If an individual lubrication point appears to be over or under lubricated, replace the metering cap for that line with a different size (too wet = smaller size; too dry = larger size).

6-8. Fasteners

6-8.1 Interior Fasteners

**WARNING**

Mounted items may come loose during operation. Inspect threaded fasteners periodically. Tighten or replace loose fasteners immediately.

Loose items can create safety hazards during operation or become projectiles in a crash.

This vehicle may include items in the cab or other riding compartments that are mounted with threaded fasteners (screws or nuts and bolts). Mounted items may include mounting plates or devices, cabinet doors, seats, hinges, hooks, covers, or other items that need to be secure during operation. In some cases the natural vibration of the vehicle may cause these fasteners to loosen over time. All fasteners should be inspected periodically to ensure that they are secure and tight. Fasteners that do not hold securely should be reviewed by maintenance personnel for repair or replacement.

6-8.2 Frame Fasteners

NOTE: Trucks built after July 2015 use Magni 575 - coated fasteners. Any hardware ordered through aftermarket will also be Magni 575. Certain sizes of Magni 575 hardware have different torque values compared to the stander fastener.

Inspect all frame assembly fasteners. Tighten any loose fasteners using the values in [Table 6-2](#) or [Table 6-3](#) for the proper size/thread pitch of hardware. Torque fasteners using a calibrated torque wrench. Replace frame fasteners with quality hardware of the same type and grade only.

Table 6-2: Grade 8 Course Thread Fastener Torque Chart

Size	Torque (Standard Coated)		Torque (Magni 575)
	In-Lbs	Ft-Lbs	Ft-Lbs
1/4-20	129		
5/16-18	265		
3/8-16		39	
7/16-14		63	
1/2-13		96	85
9/16-12		138	
5/8-11		191	180
3/4-10		339	285
7/8-9		545	
1-8		818	

Table 6-3: Grade 8 Fine Thread Fastener Torque Chart

Size	Torque	
	In-Lbs	Ft-Lbs
1/4-28	147	
5/16-24	294	
3/8-24		44
7/16-20		70
1/2-20		108
9/16-18		154
5/8-18		216
3/4-16		378
7/8-14		602
1-12		895
1-14		918

6-8.3 Bumper Extension Carriage Bolts

Torque the 1.00-8 UNC carriage bolts that fasten the bumper extension to the frame assembly to 400 ft-lbs.

6-8.4 Other Fasteners

Standard torque requirements can be found in the Pierce Service Manual, group 9600-P-001, Fastener Identification & Torque.

Refer to the component manufacturer's service publications for the proper torque for fasteners installed into component housings such as axles, engine, transmission, steering gear, and suspensions.

6-9. Fifth Wheel Lubrication (*Tiller Only*)

NOTE: Every 3,000 miles or 6 months, grease the fifth wheel bearing connecting the tractor to the tiller trailer.

6-9.1 Grease Fitting Location

Figure 6-3: Fifth Wheel Bearing Grease Fittings



1093

There are two grease fittings (1) remotely mounted on the upper fifth wheel weldment (2), directly above the fifth wheel bearing. Each fitting is connected to the bearing with grease line tubing, spaced 180 degrees apart. Each of the grease fittings are easily reached by standing next to the rear chassis tires.

6-9.2 Lubrication Procedure

WARNING

If an operator is being used to reposition the vehicle during this procedure, the service technician must remain clear of the vehicle when the tractor/trailer is being repositioned. Failure to comply may result in personal injury or death.

CAUTION

To distribute the grease throughout the circumference of the bearing, the bearing needs to be rotated by pivoting the tractor/trailer combination during the procedure. Failure to follow this procedure completely may result in areas of the bearing being under-lubricated.

1. Position the tractor / trailer in a jackknife condition, 90 degrees to one side.
2. Put the transmission in NEUTRAL and apply the parking brake.

MAINTENANCE

3. Using a grease gun, dispense two pumps of grease into each grease fitting.
4. Reposition the unit approximately 20 degrees from the jackknife position (70 degrees from straight ahead), put transmission in neutral, apply parking brake and dispense two more pumps of grease into each fitting.
5. Repeat this procedure every 20 degrees (a total of 10 grease positions) until the unit is in the opposite jackknife position.

Axles, Brakes and Suspension

6-10. Axles

6-10.1 Front Axle – Non-Driving

Inspect the front axle for damaged, binding, or worn parts. Check the kingpins for excessive wear. Refer to the axle manufacturer's maintenance manual (included in the Pierce Service Manual) for maintenance schedules, lubrication recommendations, and inspection procedures.

6-10.2 Front Axle Alignment



Most tire wear is caused by incorrect toe settings. Do not change camber or caster settings to correct tire wear problems. If the axle assembly is bent to change caster or camber, the strength of the axle is reduced and the warranty is voided. An axle damaged by bending may cause a vehicle accident and result in serious personal injury or death.

Kingpin inclination and camber are factory set by the axle manufacturer and are not adjustable. Caster is set at the factory by including tapered shims in the front spring pack as required.

Check toe-in adjustment by following the instructions in the axle manufacturer's maintenance manual. Set toe-in to the following values:

Unloaded Vehicle: 1/16-inch \pm 1/32 inch

Loaded Vehicle: 1/32-inch \pm 1/32 inch

6-10.3 Front Axle – TAK-4™ Suspension

Refer to the Pierce Service Manual, group 0152-P-004, TAK-4™ Maintenance, Inspection, and Troubleshooting, for suspension inspection information.

Refer to the Pierce Service Manual, group 0601-P-002, TAK-4™ Steering Components and Adjustments, for alignment information.

6-10.4 Rear Axle

Inspect the rear axle for damage, leaks, or interference's with other chassis components. Refer to the axle manufacturer's maintenance manual (included in the Pierce Service Manual) for maintenance schedules, lubrication recommendations, and inspection procedures.

6-10.5 Rear Axle Alignment

IMPORTANT: U-bolt nut torque is critical to maintaining rear axle alignment. It is natural for the paints and lubricants in the spring pack to compress over time and cause the U-bolt clamp force to drop. This is particularly true soon after factory assembly or whenever the U-bolts are loosened or the springs are replaced. It is the owner's responsibility to torque the U-bolts after the first 500 miles of operation or six months whichever comes first, and then at the recommended maintenance intervals or axle alignment will likely be affected. Refer to "[Spring Suspension \(Front and Rear\)](#)" on [page 6-13](#) for U-bolt torque.

Check that the rear axle is aligned perpendicular to the chassis frame using high quality and properly calibrated laser alignment equipment operated by a trained technician. Slight adjustment may be made by loosening the U-bolts and repositioning the axle within the clearance of the axle locating pins.

6-10.6 Rear Axle – TAK-4™ Suspension

Refer to the Pierce Service Manual, group 0201-P-001 (steering), or 0201-P-002 (non-steering) TAK-4™ Maintenance, Inspection, and Troubleshooting, for suspension inspection information.

Refer to the Pierce Service Manual, group 0601-P-005, TAK-4™ Steering Adjustments (steering) or group 0601-P-006, TAK-4™ Steering Components and Adjustments (non-steering) for alignment information.

6-11. Brakes

6-11.1 Brakes – General

WARNING

All new Pierce Custom Chassis are equipped with non-asbestos lining material. Even so, great care should be taken to avoid the inhalation of brake lining material dust during the servicing of the brakes, as brake lining fiber dust may be extremely hazardous to your health. Read and follow the precautions listed in the Brake section of the Pierce Service Manual or serious personal injury may result.

IMPORTANT: Do not use Lithium base grease on disc brake calipers. Lithium base grease may not adequately lubricate the calipers. Only use clay-based NLGI Grade numbers 1 or 2, or equivalent. Disc brake calipers are NOT to be connected to automatic chassis lubrication systems. For vehicles equipped with an automatic lubrication system, disc brake calipers will need to be greased separately.

The inherent duty cycle of fire apparatus requires the use of very aggressive brake lining material. For this reason, fire apparatus vehicles are very sensitive to brake balance. Refer to "[Brake Balance](#)" on [page 3-2](#) before addressing brake related service problems.

Brake wear varies widely depending on vehicle use factors such as operator driving habits, terrain, speeds, road conditions, and use of auxiliary braking devices. Establish a regular schedule for inspection, maintenance, and lubrication based on the duty cycle of the vehicle. Inspect brake linings weekly until a normal wear rate can be determined and an appropriate inspection schedule established. Refer to the axle manufacturer's maintenance manual (included in the Pierce Service Manual) for maintenance schedules, lubrication recommendations, and inspection procedures.

Inspect the entire brake system for the following:

- Air leaks.
- Condition of drums, rotors, brake chambers, and slack adjusters.
- Condition of hoses, fittings, and tubes.
- Proper operation of service, and parking brakes.

6-11.2 Brakes – TAK-4™ Suspension

Front TAK-4™ Suspension

Brake information for front TAK-4™ suspension-equipped chassis can be found in the Pierce Service Manual, group 0251-V-005, Bendix SN7 Air Disc Brakes.

Rear TAK-4™ Suspension

Brake information for rear TAK-4™ suspension-equipped chassis can be found in the Pierce Service Manual, group 0251-V-019, Bendix EB & ES Air Drum Brakes.

6-11.3 Air Dryer

Inspect the air dryer to ensure that it is exhausting properly at each cycle of the air compressor governor. Replace the desiccant cartridge every 2 to 3 years or more often depending on usage. Refer to the air dryer maintenance manual (included in the Pierce Service Manual) for maintenance schedules, lubrication recommendations, and inspection procedures.

6-12. Rear Suspension

Refer to the rear suspension manufacturer's maintenance manual (included in the Pierce Service Manual) for maintenance schedules, lubrication recommendations, and inspection procedures.

6-13. Spring Suspension (Front and Rear)

6-13.1 Springs

Inspect spring leaves for signs of wear, cracking, or bending.

Check for damage to spring stops.

CAUTION

Failure to follow these requirements for torquing and servicing U-bolts and nuts may allow the axle to shift on the spring pack causing misalignment of the axles.

IMPORTANT: Pierce Manufacturing does not approve, disapprove, or endorse the use of any aftermarket or add-on suspension systems, including aftermarket springs. Installation of any such aftermarket or add-on system is entirely at the discretion and risk of the customer.

Torque the U-bolt nuts (in conjunction with a wheel alignment) after the chassis has been operated for 500 miles or six months, whichever comes first. Re-torque nuts thereafter every 24,000 miles or annually, whichever comes first.
Torquing Procedure:

1. Clean around the U-bolt to nut joint to remove dirt and grime.
2. Tighten U-bolt nuts evenly in a crisscross pattern.
3. Torque to proper value using a calibrated torque wrench per the following charts.

Table 6-4: U-Bolt Fastener Torque Chart

U-Bolt Diameter	Torque	
	Ft-Lbs	N-m
3/4"-16	240-260	325-355
7/8"-14	400-420	540-570
1"-14	500-520	680-705

Replace U-bolts with same size grade 8 U-bolts whenever they are removed. Reinstall using the torquing procedure noted above. Re-torque after 500 miles of service.

Spring seats, spacers, and shims act to support the spring pack and are important members of the suspension. Any additional spacers or shims must be selected properly. Upper and lower spring seats and any spacers that are replaced or added to the suspension assembly must be the same length and width as the original equipment. Replacing or adding spring seats, spacers, or shims incorrectly may affect spring performance or durability.

6-13.2 Suspension Shackles

Inspect suspension shackle and hanger clamp bolts. Tighten any loose fasteners to the proper values using a calibrated torque wrench ([Table 6-5](#)):

Table 6-5: Clamp Bolt Torque Chart

Size	Torque	
	Ft-Lbs	N-m
3/8"-16	26	35
7/16"-14	42	57
1/2"-13	64	87

6-13.3 Spring Pins

Lubricate spring pins with NLGI grade EP2 grease until grease oozes evenly from ends of each pin. If grease will not flow, raise chassis to remove the load on the springs and apply grease again. If grease will still not flow, disassemble spring pins and clean or replace as required.

6-14. TAK-4™ Suspension

6-14.1 Front TAK-4™ Suspension

Refer to the Pierce Service Manual, group 0152-P-004, TAK-4™ Maintenance, Inspection, and Troubleshooting, for suspension inspection information.

Refer to the Front Axle & Suspension chapter of the Pierce Service Manual for additional TAK-4™ service group information.

6-14.2 Rear TAK-4™ Suspension

Refer to the Pierce Service Manual, group 0201-P-001 (steering), or 0201-P-002 (non-steering) TAK-4™ Maintenance, Inspection, and Troubleshooting, for suspension inspection information.

Refer to the Rear Axle & Suspension chapter of the Pierce Service Manual for additional TAK-4™ service group information.

Electrical

6-15. Command Zone™ System

6-15.1 Overview

Figure 6-4: Traditional Electrical System

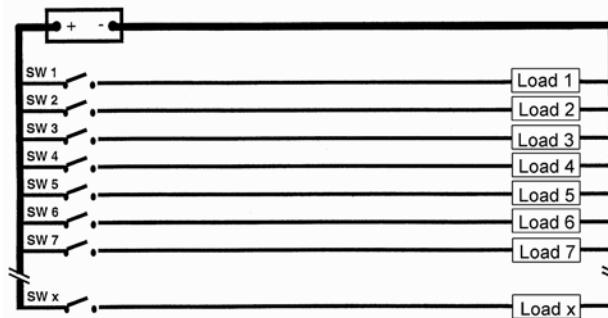

POM0111

Figure 6-5: Pierce Command Zone™ Multiplex System

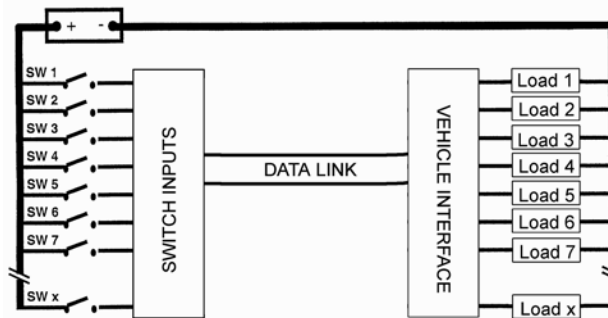

POM0112

The multiplex electrical system is different from most traditional electrical systems. Traditional truck electrical systems (Figure 6-4) use individual wires, switches, and components to operate discrete systems. This usually results in the use of large power distribution boxes and large main wiring harnesses. Many electro-mechanical relays are also needed to perform operational interlock functions.

The Pierce Command Zone™ multiplex system (Figure 6-5) uses a single, three-wire, wire harness or data link to connect switches and controls (inputs) to system loads and devices (outputs). The use of this single data link vastly reduces the amount of wiring used within an electrical system. System inputs and outputs are connected to modules located along the single data link.

The input from several switches is combined together in an input/output or input module which connects to the data link. Similarly, many outputs are connected together in an output module or power module which also connects to the data link. In most cases the power module controls the higher amperage load of the components. A control module is used to interpret switch functions, facilitate communications with other multiplex devices, and perform desired interlock functions.

Additional information on the Command Zone™ system can be found in the Pierce Service Manual, group 0950-P-009, Command Zone™ Advanced Electronics.

6-15.2 Multiplex System Principals of Operation

Figure 6-6: Pierce Multiplex System Operation

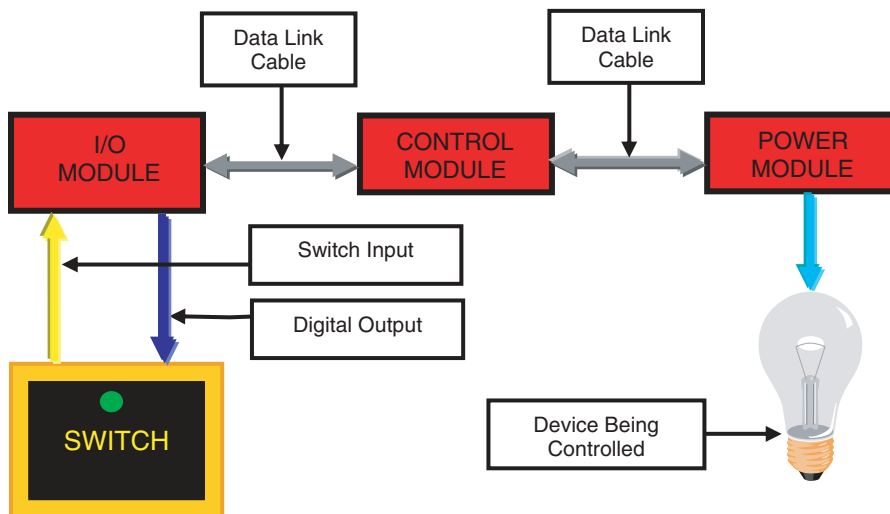

POM0113

NOTE: The Command Zone™ Information Center (CZIC) also has switch input capabilities.

The functionality of a simple multiplex system is explained in the following paragraphs. While the system shown here has a single Input/Output (I/O) Module and Power Module, typical vehicles have several modules located in various places on the truck.

- Step 1 The operator activates a switch (rocker or membrane) for a specific function. This information is received by the I/O Module, which transfers this information to the Control Module via the data link.
- Step 2 The change in switch position information is received by the Control Module, which interprets the information and verifies that all necessary interlocks have been satisfied (if applicable).
- Step 3 The Control Module then sends an indicator light activation message (via the data link) back to the I/O Module, which then causes the I/O Module to turn on the indicator light located on the switch.
- Step 4 At the same time the indicator light information is processed, the Control Module determines which Power Module output should be turned on and sends that information via the data link.
- Step 5 The power module - which is constantly monitoring the information on the data link - interprets the Control Module information and grounds the appropriate output pin location on the Power Module, which in turn activates the device.

6-15.3 Troubleshooting Tips

CAUTION

Make sure you are properly trained before attempting to service a multiplex system.

Because of significant differences between traditional electrical systems and the multiplex system, different tools and skills are required to troubleshoot multiplexing faults.

Command Zone™ Diagnostics

This computer software is used to connect a conventional laptop PC to the vehicle's control module. The software allows a mechanic to interrogate components within the multiplex system to determine the status of individual input and output circuits.

Input/Output Sheets (I/O Sheets)

IMPORTANT: I/O sheets may be required to diagnose some multiplex related faults. These sheets should be kept with the vehicle at all times. Replacement I/O sheets can be obtained by contacting Pierce Manufacturing.

These vehicle-specific information sheets are generated during the design of a new vehicle and are invaluable for troubleshooting. Due to the wide range of custom equipment found on Pierce apparatus, each electrical system is designed for that specific application. I/O sheets provide instructions for the specific input and output locations for each electrical circuit on the vehicle. Limited wiring diagram information is also included on the sheets.

Component LED Heartbeat (Red)

This is a blinking LED that is located on all multiplex modules. This LED blinks at the rate of one blink per second, and indicates that the module is capable of communicating with other modules on the data link. Also a steady green LED indicates B+ (battery) and ground to each module.

Input Module (Clear Case Option)

A label identifies the input corresponding to the LED. If the LED is on, the module is seeing an input from a device.

Input/Output Module (Clear Case Option)

A label identifies the input/output corresponding to the LED. If the LED is on, the module is seeing an input from a device or the module output is active.

Output/Power Module (Clear Case Option)

A label identifies the output corresponding to the LED. If the LED is on, the module output is active.

Data Link Troubleshooting

The data link consists of three wires: two insulated wires and one shielding wire. The two insulated wires are called "CAN L" and "CAN H." CAN L is a green wire (Pin B); CAN H is a yellow wire (Pin A). Secondary locks are installed on all data link connectors to prevent the data link from coming apart.

A 120 ohm terminating resistor plug is installed at each end of each J1939 data link. When the system is functioning properly, the system will read 59-61 ohms across pins "A" and "B" of the data link connector. If this resistance is not maintained, an intermittent system fail or communication lost message may appear on the CZIC.

An ohm reading of approximately 120 ohms indicates a terminating resistor that is missing, or a data link that is open (loose connection). A 40-ohm reading indicates that an extra terminating resistor plug has been installed in the data link.

Non-Command Zone™ Components

Never assume that the cause of the problem is the multiplex system. Check the device; it may be defective. Perform all basic electrical checks (fuses, circuit breakers, wiring connections, terminals, etc.) before assuming the worst.

6-16. Electrical, DC

6-16.1 Alternator

Proper belt tension is essential to avoid squealing, slipping, or throwing of alternator belts. Proper belt tension should be checked using a Burrows Tension Gauge or equivalent. Refer to *“Fan and Accessory Belts”* on page 6-22 for belt installation instructions and proper belt tension values.

6-16.2 Batteries

Terminals

Make cable connections as corrosion resistant as possible by coating the connections with a heavy general purpose grease or battery terminal protection product. Tighten the cable clamps to the battery posts before applying the grease. This prevents the grease from getting between the clamps and the posts, and thereby restricting the flow of electrical current.

Cleaning

Batteries can be cleaned with a brush dipped in a baking soda or ammonia solution. Make sure the battery caps are tight to prevent the solution from entering the battery. After cleaning, flush with water. Clean battery terminals with a steel wool or a wire brush. Keep terminals clean and tight. Make sure vent holes in the battery caps are open.

6-16.3 Wire Harnesses and Electrical Connectors

CAUTION

When adding electrical accessories, choose mating connectors and terminals carefully to avoid electrolytic corrosion. Joining connectors of dissimilar material can cause a chemical reaction that will quickly corrode the joint, and electrical conductivity will be reduced or lost.

Inspect electrical connections for corrosion, looseness, or heat damage. Clean, tighten, or replace as necessary. Inspect all wire harnesses and look for evidence of broken wires, chafing, or heat damage. Repair or replace as necessary.

6-17. Electrical, AC

6-17.1 Alternating Current (AC) System (120V-240V) Introduction

This vehicle may be equipped with line voltage power supplied either from a shore-line (vehicle plugged into an external outlet) or from an on-board source. Before attempting any service or inspection of electrical components or wiring, any source of line voltage power should be de-energized. Unplug shore line power. Shut down or turn off any on-board generator or inverter power source. Only qualified personnel should be allowed to service line voltage equipment or wiring. Before working on line voltage electrical equipment or wiring, perform a procedure for the control of hazardous energy sources (lockout/tagout) in a program complying with 29 CFR Part 1910.147. Follow NEC guidelines for safe working methods.

⚠ WARNING

Disconnect power before removing any line voltage breaker box cover or junction box cover or working on line voltage wiring. Follow National Electrical Code safe practices. Electrical shock can injure or kill.

To avoid property damage, personal injury, or death, refer to the manufacturer's service information before working on any high voltage equipment. By definition, high voltage circuits and components contain voltage levels that may cause equipment damage, electrical shock and/or electrocution if handled incorrectly.

All electrical circuits associated with Auxiliary Power Units (APUs), shore power, and inverters should be considered high voltage.

The main difference between AC and Direct Current (DC) systems is that the voltage levels in DC systems remain constant, while the voltage levels in AC systems are constantly changing. When measuring an AC system, it is important to know that the average voltage is zero and that is why **A VOLTMETER SET TO DC WILL NOT INDICATE THE PRESENCE OF AC VOLTAGE WHEN CONNECTED TO AN AC CIRCUIT!**

High voltage can be lethal. Always refer to the high voltage equipment manufacturer's service information when maintenance or repairs are needed. In most cases, diagnostics and repair are performed after the high voltage circuits are disabled. If you work around or maintain high voltage circuits, please seek high voltage training.

⚠ WARNING

To avoid property damage, personal injury or death, circuits must be checked using a voltmeter for the presence of both DC and AC voltages. A voltmeter set to DC will not indicate the presence of AC voltage when connected to an AC circuit. Contacting an unknown AC or DC voltage may cause equipment damage, electrical shock and/or electrocution.

Only trained technicians may perform service inside high voltage components. If you work around or maintain high voltage circuits, please seek high voltage training.

6-17.2 Auxiliary Power Units (APUs)

NOTE: High voltage APU wiring may NOT be marked for easy identification as high voltage.

APUs are basically small diesel powered generator units that are integrated into the vehicle's electrical system. APUs are utilized in combination with inverters and battery chargers. APUs are often set up to automatically start when the electrical management system deems it necessary to maintain battery charge or when the electrical demand requires it.

6-17.3 Shore Power

NOTE: High voltage shore power wiring may NOT be marked for easy identification as high voltage.

Shore power is a connection from a vehicle to an external 120V AC power source. The vehicle is equipped with an exterior receptacle that allows connection to an external "shore" power source.

6-17.4 Inverters

NOTE: High voltage inverter wiring may NOT be marked for easy identification as high voltage.

Inverters are electronic devices used to change Direct Current (DC) to Alternating Current (AC). Some inverters contain converters that also convert AC to DC for battery charging and/or running 12V equipment.

6-17.5 Before Servicing High Voltage Equipment

- Be aware of ALL high voltage equipment on the vehicle; review the high voltage equipment found on the electrical diagrams and in the service manual **BEFORE** starting any work.
- When working on this equipment, remain alert at all times. Never work on the equipment when you are physically or mentally fatigued and never work alone near high voltage equipment.
- Always stand on an insulated, dry surface when working on any electrical circuit. Do not handle any kind of electrical device while standing in water, while barefoot, or while hands or feet are wet.
- Always work in an adequately illuminated area.
- Always use appropriate protective equipment: insulated gloves, rubber gloves, goggles/face shield, safety shoes, protective clothing, and insulated tools when working on electrical components/circuits of the vehicle.
- Never wear jewelry when working on this equipment. Jewelry can conduct electricity, resulting in electrical shock or burns, and may get caught in moving components causing injury.
- When working on vehicles that have high voltage devices or equipment, use appropriate alerting techniques in plain view to warn people that may be in the general area and to prevent inadvertent activation of any disabled high voltage circuit(s) during service: safety signs, safety symbols, tags, barricades, cones, etc.
- Keep a fire extinguisher close by at all times. Extinguishers rated "ABC" by the National Fire Protection Association are appropriate for use on the electrical system. Make sure the extinguisher is properly charged and be familiar with its use.
- Ensure that the high voltage power, high voltage power generating equipment, and high voltage storage devices are disconnected, locked out, or otherwise disabled **BEFORE** working on or around the vehicle, its electrical circuits, or components. Unless disabled, Auxiliary Power Units (APUs) may start at any time without warning; when this occurs, the circuits associated with the APU become energized with potentially lethal high voltage. Some components may require a waiting period or special procedures to discharge the voltage completely.
- Use an appropriate electrical tester and procedures to confirm that the power is disconnected **BEFORE** performing any work on or near any high voltage components/circuits.
- Exercise caution around output circuits even when the input power is off. Parallel power sources and energy storage devices can still be dangerous. Be familiar with the high voltage equipment installed on the vehicle. Some systems contain high voltage condensers that may require time to discharge after power is removed.
- After disconnecting or exposing a high-voltage connector or terminal, insulate it immediately using insulation tape.
- After completion of any electrical work, **BEFORE** restoring the power, verify that parts and or tools are removed from the work area and that the fasteners are firmly tightened to the specified torque and the connectors are correctly connected.
- Voltage can be fatal at levels greater than 60 volts. High voltage can jump a larger air gap than low voltage. If contact is made with high voltage it may not be possible to simply "let go".
- If a high voltage fuse or circuit protection device trips, do not re-energize the circuit until it has been determined that the circuit is safe. See manufacturers troubleshooting procedures before servicing a high voltage system.
- Reference OSHA Regulations as necessary and applicable.

Engine, Cooling, Fuel and Exhaust

6-18. Engine

6-18.1 Air Intake System

CAUTION

Failure to inspect the air intake system for leaks in the tubing and connections may lead to extensive damage to internal engine parts.

Periodic Inspection

Inspect the following:

- Air filter housing for cracks caused by distortion or vibration.
- Flexible ducts for damage and loose fasteners.
- Air filter mounting for loose fasteners and cracks.
- Air tubing supports. Loose or broken supports can cause excessive vibration and open cracks in the system.
- Connecting clamps for dents, bends, and tightness.
- Tubing and elbow connections by wiping clean and checking thoroughly for cracks.
- Cables, control rods, hoses, or lines for chafing against tubing and connectors.
- If the air intake manifold or the compressor intake flange is suspected of being loose, consult the engine manufacturer's manual for torque values and tighten retaining nuts to specifications.

Air Filter Replacement

Replace the air filter or air filter element when indicated by the air intake restriction lamp on the instrument panel. When replacing the filter or filter element, be careful not to allow dust or dirt from the old filter to contaminate the clean side of the intake plumbing. Contact Pierce Customer Service for replacement filters.

Moisture and Ember Separators

All Pierce Custom Chassis are equipped with an ember and moisture separation screen located upstream of the air filter. The primary function of this screen is to remove water particles from the intake air before it reaches the air filter. The screen can be removed for cleaning. Inspect the screen for buildup of dirt or debris. This screen must be kept clean to minimize air intake restriction to the engine and ensure peak engine output. Remove the screen and clean with soap and water.

6-18.2 Air Intake and Charge Air Cooler Hose Clamps

Tighten T-Bolt style hose clamps to 90-100 in-lbs.

Tighten Spring T-bolt clamps to 45-70 in-lbs.

6-18.3 Fan and Accessory Belts

Belts should be checked for frayed areas, cracks, and general wear. Always replace all belts in a set even though only one may be defective. Inspect belts weekly.

Belt Inspection and Installation

Proper belt tension is critical to maintaining belt life. Too much tension will over stress the belt as well as the pulleys and bearings. Too little tension will allow the belt to slip during heavy loading. This will glaze the belt surface, reduce surface friction, increase slippage, and ultimately lead to belt failure. All Pierce Custom Chassis utilize automatic belt tensioners which are not adjustable.

Multi-rib drive designs may use pulleys that have more grooves than the belt. One of the pulleys in the drive system will match the belt width. Use this pulley to align the belt and install in the correct groove on the wider pulley. A straightedge against the face of the aligning pulley will provide an accurate guide for the alignment of the belt.

6-18.4 Engine Service Schedule

Maintenance, lubrication, and inspection schedules vary among engine models and manufacturers. Refer to the engine manufacturer's maintenance manual for maintenance schedules, lubrication recommendations, and inspection procedures.

It is the owner's responsibility to ensure that the engine is maintained properly. Retain all service reports and receipts, and transfer these records in the event that the vehicle changes hands.

Use only genuine Original Equipment Manufacturer (OEM) parts or parts of equivalent quality and functionality when servicing engines. Replacement of parts with those of inferior quality may lead to lower performance, reduced engine life, or component failure.

6-18.5 Engine Mount Isolators

Inspect the engine and transmission isolators for cracks, debonding or other signs of excessive wear. Replace worn isolators with Pierce supplied parts only to ensure that proper isolation is maintained.

6-18.6 Engine Diagnostic Software - *Detroit*

2010 EPA & 2013 EPA Detroit engines require Detroit Diagnostic Link (DDDL) software version 7.06 for diagnostic support. The DDDL 7.06 package supports both 2013 EPA and older engines. Contact a Detroit service location to obtain a copy of DDDL.

6-18.7 Engine Diagnostic Software - *Cummins*

2010 EPA & 2013 EPA Cummins engines require Cummins Insite software version 7.4.2 (or newer) for diagnostic support. Contact a Cummins service location to obtain a copy of Cummins Insite.

6-19. Cooling System

The most efficient cooling system is one that keeps the coolant at proper temperature for efficient engine operation regardless of engine speed or load. When coolant temperature is below normal, fuel may not burn readily or produce its full power. When water temperature is excessive and the engine is operating under full load, lubricating oil may get so hot and thin that it cannot lubricate effectively. Every part of the cooling system requires attention.

6-19.1 General Inspection and Service

WARNING

Always allow the engine to cool before opening the pressure cap. Wrap a thick, heavy cloth around the cap. Push down, and turn the cap to the first notch position. Pause before opening completely to allow any remaining pressure to escape. Follow this procedure to avoid burns from hot steam or coolant.

Wear safety goggles when blowing debris from radiator, or damage to eyes may result.

CAUTION

Do not use antifreeze with a “stop leak” additive as this additive may clog the cooling system.

Always fill coolant system properly and completely, or serious engine damage may result.

1. Check the engine coolant level (with engine stopped). The engine water pump can draw air as well as coolant when the coolant level drops below the coolant make-up line connection at the radiator or the top of the radiator core.
2. Fill radiator or surge tank to proper level with permanent-type antifreeze and water. See “*Antifreeze Type*” on [page 6-25](#). Water should be clean and free from any corrosive and scale forming chemicals (not softened water). Radiators and oil coolers that get dirty inside and outside lose their ability to absorb and radiate heat.
3. Clean radiator and charge air cooler using compressed air to remove bugs, dirt, and other debris. Steam clean annually. Clean from the side opposite the direction of airflow.
4. Check for leaks and straighten bent fins with needle-nose pliers.

6-19.2 Hoses

Check for soft, mushy feel or swelling. Also look for cracks in the hose around the clamp area. Replace defective hoses.

6-19.3 Hose Clamps

Constant torque type hose clamps are used on most coolant lines. These clamps should be installed during initial assembly or reassembly with to a torque of 100 in-lbs. The clamp will likely drop in torque value after exposure to hot coolant and should be maintained to a torque of 45 in-lbs thereafter.

Tighten standard worm-drive style clamps to 30-45 in-lbs. The clamp will likely drop in torque value after exposure to hot coolant and should be maintained to a torque of 30 in-lbs thereafter.

Replace clamps as required with same style as originally supplied.

6-19.4 Water Pump

Inspect water pump and hose connections for leaks.

6-19.5 Thermostats

Check thermostats yearly. Install new ones if necessary. Thermostats are stamped with the opening temperature. For example, a thermostat marked 175°F (70°C) indicates that this is the approximate temperature at which the thermostat starts to open. A thermostat is fully open at approximately 20°F (11°C) above the opening temperature. Observe engine temperature gauge to check thermostat operation.

6-19.6 Coolant

WARNING

Radiator, radiator cap, coolant, and hoses are very hot and pressurized during truck operation. Let radiator cool before checking system.

Use extreme care when removing the radiator cap. Always allow engine to cool completely before opening radiator cap. Wrap a thick, heavy cloth around cap. Push down and turn radiator cap to first notch position. Pause before opening completely to allow any remaining pressure to escape. Failure to comply could result in burns from hot steam or coolant.

CAUTION

Proper corrosion inhibitor levels must be maintained to prevent premature engine failure. Refer to the engine manufacturer's manuals for proper checking procedures.

Use a refractometer to check coolant solution. Follow the manufacturer's mixing proportions to obtain desired protection.

Drain, flush, and refill cooling system annually. Refer to the Pierce Service Manual, group 0401-P-003, Cooling System Service, and the engine manufacturer's operator's manual for additional information.

6-19.7 Antifreeze Type

CAUTION

Selecting the proper antifreeze type is vital to system performance. Mixing antifreeze types may result in decreased performance and corrosion protection, and may result in engine damage that may not be covered under the engine manufacturer's warranty.

ALWAYS verify the antifreeze type used in your vehicle. Select an equivalent type which meets or exceeds the engine manufacturer's standards.

Refer to the engine manufacturer's Operator and Maintenance manual(s) for approved coolant types, mixtures, inhibitors, and additional information.

NOTE: It is recommended to replenish or refill the cooling system with antifreeze not only of the same type, but also the same color. Mixing colors can create a muddy appearance which makes visual inspection more difficult.

Figure 6-7: Antifreeze Type Information Labels



EXTENDED-TYPE INSTRUCTION LABEL



STANDARD-TYPE INSTRUCTION LABEL

2872361, 91-9393

The type equipped at initial fill may be identified by a label on or near the radiator fill cap. Identify this label and refer to your engine manufacturer's Operation and Maintenance manual for approved coolant types **BEFORE** adding to or replacing the coolant mixture. Different types of antifreeze may be formulated with different chemicals and types of corrosion inhibitors, which may not react well with existing coolant in the vehicle, or engine or cooling system components.

Depending on date of manufacturer, your Pierce truck may be equipped with one of two coolant types:

- Standard Type: Typically green in color, standard drain intervals, SCA inhibitors.
- Extended Type: Yellow in color, extended drain intervals, nitrate-free OAT type inhibitors. This type may be obtained through your Pierce dealer, or by obtaining the following types produced in yellow color:
 - Shell Rotella Ultra ELC™
 - Volvo Penta Coolant VCS (Yellow)
 - Chevron Delo® Extended Life NF

6-19.8 Coolant Fill Procedure

WARNING

Radiator, radiator cap, coolant, and hoses are very hot and pressurized during truck operation. Let radiator cool before checking system.

Use extreme care when removing the radiator cap. Always allow engine to cool completely before opening radiator cap. Wrap a thick, heavy cloth around cap. Push down and turn radiator cap to first notch position. Pause before opening completely to allow any remaining pressure to escape. Failure to comply could result in burns from hot steam or coolant.

NOTE: Add coolant ONLY to the pressurized surge tank (or radiator top tank). DO NOT add coolant to the un-pressurized recovery bottle, if present. The recovery bottle is intended to serve as expansion space for the coolant as it heats up. The volume of the recovery bottle may not be adequate to accommodate the coolant expansion if it is not EMPTY when the engine/cooling system is at room temperature.

1. Open heater circuits: set all heater controls to the hottest position and verify that heater shut-off valves are open.
2. Some systems may have a vent petcock in the upper coolant tube between the engine outlet and the radiator inlet. If present, open the vent petcock and place a container underneath the petcock to capture the small amount of coolant that will flow out during the fill process.
3. Remove pressure cap and fill the system at a rate of approximately 2-3 GPM. Observe the vent petcock while filling and close it securely after coolant begins to flow from the petcock. Continue filling until the surge tank is full to the point of overflowing. If coolant has not yet begun flowing from the vent petcock, wait until this occurs. Refill surge tank as necessary until the coolant level remains in the sight glass AND has flowed out the vent petcock. Be sure to close the vent petcock, if present.
4. Start engine and run at idle. Stop and check the coolant level after approximately 1 minute. Top off coolant and repeat this step as necessary until the coolant level remains in the sight glass.
5. Install the pressure cap on the surge tank.
6. Run engine at increased rpm until the thermostat opens. The temperature gauge should read a minimum of 185°F (85°C) for Cummins engines, and 195°F (90°C) for the Detroit DD13 engine. Main coolant tubes and/or lines leading to the auxiliary pump mode engine cooler (if present) should be hot, indicating the presence of coolant flow.

7. Monitor coolant level and engine / low coolant warning lamps while running; stop as necessary to top off the coolant. Allow the system to cool completely before removing the pressure cap.
8. After the system has cooled to room temperature, verify that the coolant level is in the surge tank sight glass. Filling above the sight glass level with a cold engine is not recommended, since this will reduce the trapped air space that is available for expansion as the coolant temperature increases.

System is full when no additional coolant can be added and heater lines are hot, indicating the presence of coolant.

6-20. Fuel System

6-20.1 Fuel Delivery System

Inspect fuel system for signs of damage, leaking, or chafing. Replace or repair as necessary.

6-20.2 Fuel Filters

Diesel fuel injection nozzles are manufactured to an accuracy of a few thousandths of a millimeter and are matched precisely to each other. Impurities in the fuel can subject fuel injector components to premature damage or wear. Replace fuel filters in accordance with the engine manufacturer's recommendations.

6-21. Exhaust System

WARNING

On all 2010 EPA & 2013 EPA diesel engines, the exhaust temperature can reach 1350°F during an active regeneration cycle. An active regeneration cycle could occur automatically whenever the speedometer indicates a speed above 5 mph. This can occur when the vehicle is in motion, or when the apparatus is operating in stationary pump mode with an engine rpm sufficient to indicate 5 mph on the speedometer. An exhaust temperature mitigation device is included at the tailpipe to reduce high exhaust temperatures before the exhaust exits the tailpipe. Extreme caution should always be used when working in the vicinity of the exhaust outlet. Failure to heed this warning may lead to personal injury or death.

IMPORTANT: Periodic exhaust inspection is particularly important with all 2010 EPA & 2013 EPA diesel engines. The muffler is part of the Diesel Particulate Filter (DPF). The exhaust pipe ahead of the DPF will be wrapped with heat insulation. The insulation is critical to the DPF active regeneration performance. If the insulation is damaged or missing, the internal DPF temperature may not be high enough to burn off the particulates (soot). Likewise if pipe clamps are loose, critical heat may escape, affect the regeneration performance and emissions compliance.

Inspect exhaust pipe connections to check for loose clamps or corrosion. Repair or replace as necessary. Refer to the engine manufacturer's maintenance manual for additional information on the Diesel Oxidation Catalyst (DOC) and Diesel Particulate Filter (DPF).

6-21.1 General Notes for All 2010 EPA & 2013 EPA Engines

No modification of the exhaust between the engine, Diesel Particulate Filter (DPF), and Selective Catalytic Reduction (SCR) is allowed per the EPA. Only tailpipes after the SCR are allowed to be changed.

CAUTION

All customer installed hardware needs to be kept a minimum of 6 inches away from any exhaust pipe and After Treatment Device (ATD) housing. Failure to comply may result in heat related damage to the aftermarket components.

6-21.2 Exhaust Diffusers

NOTE: All 2010 EPA & 2013 EPA engines with Diesel Particulate Filters (DPFs) are equipped with exhaust diffusers. Some Cummins ISM engines, 450 HP and higher, do not have DPFs.

Pierce Custom Chassis may be outfitted with diffuser exhaust tips. These devices lower exhaust gas temperatures as they exit the tailpipe. Exhaust Diffusers reduce exhaust outlet temperature by mixing ambient air with engine exhaust. If equipped, the Exhaust Diffuser installed on your truck should not be removed or modified in any way and must be replaced if damaged or missing. Consult your Pierce Dealer for exhaust extraction systems that are compatible with the Pierce diffuser tips.

CAUTION

Performance of the Exhaust Diffuser can be adversely affected by:

- Exhaust Diffuser ambient air inlet obstructions.
- Exhaust Diffuser outlet obstructions.
- Damage to the Exhaust Diffuser.
- Inadequate building exhaust extractor system flow capacity.

Reduced Exhaust Diffuser function can result in exhaust temperatures approaching 1200°F (649°C) at the outlet during or shortly after Diesel Particulate Filter (DPF) regeneration.

DPF regeneration can take place and high exhaust temperatures can be present while operating the truck in a stationary pumping mode.

Building exhaust extractor systems used with 2010 EPA & 2013 EPA DPF equipped engines must be designed and installed to accommodate the larger diameter pipe, accept higher exhaust flow rates and higher exhaust temperatures present with these engines.

Driveline

6-22. Driveshafts

⚠ WARNING

Fire apparatus are equipped with driveshafts and shafts used for Power Take-Off (PTO) operated accessories. Never operate the engine with shaft guards removed or with personnel in the vicinity of any rotating shaft, as they may engage without warning. Hands, clothes, hair, etc., can get caught on spinning shafts and U-joints. Failure to heed this warning may lead to personal injury or death.

CAUTION

Cease vehicle operation immediately if excessive driveline vibration occurs. Continued operation with excessive driveline vibration can cause expensive repairs to transmission, axle, or pump components.

For vehicles equipped with air suspensions, do not alter the ride height setting, or severe driveline vibration and component damage may result.

Lubricate according to the schedule found in the Pierce Service Manual, group 0501-V-001, Dana Spicer Driveshafts. Inspect driveshafts for signs of wear, interference, or looseness. Observe any loose wires, hoses, or other components that may become entangled in the spinning shaft and secure properly.

6-23. Transmission

6-23.1 Transmission Fluid

When changing to a different type of transmission fluid, care should be taken to purge the system of the old fluid before installing the new fluid. See the transmission manufacturer's Operator's manual for recommended fluids and viscosity grades.

6-23.2 Transmission Fluid Analysis

The presence of water and/or ethylene glycol coolant mixtures in the transmission oil is detrimental to the reliability and durability of the internal components. This foreign liquid has a deteriorating effect on non-metallic components (rubber, gasket material, etc.) and on highly loaded steel parts, such as bearings and gears, due to reduced lubricity. Frictional capacity of drive clutch plates can be greatly reduced, as a result of surface film or impregnation and the presence of glycol will physically deteriorate clutch plate material.

Local conditions, severity of operation, or duty cycle may require more or less frequent fluid change intervals that differ from the published recommended fluid change intervals of Allison Transmission. Transmission protection and fluid change intervals can be optimized by use of fluid analysis. The user should evaluate individual needs and determine the economics of performing an analysis. If it is suspected that foreign materials have entered the fluid system, then an analysis needs to be performed immediately.

MAINTENANCE

Fire trucks are defined as severe vocation due to retarder use and similarity to transit coach operation. Fluid should be changed every 12,000 miles, 6 months, or 500 hours.

Conditions that indicate water and/or glycol in the fluid are:

- Rust or pitted transmission parts.
- Oil spewing out of the breather.
- Oil in the radiator.
- Gaskets blistered or wrinkled in uncompressed areas.
- Appearance of oil. Presence of water in oil when dispersed is a cloudy or gray, pink, or strawberry color.
- Steam from the breather.

Should the user suspect contamination, an oil sample should be obtained when transmission oil is at normal operating temperature to assure contaminate, if present, is thoroughly dispersed in the oil as sampled. The analysis of oil sample (by the oil supplier or any qualified laboratory) will provide the degree of contaminate and possibly a clue as to its source. A minimal amount of water may be due to uncovered oil drums or an open transmission filler tube or, in the case of glycol, the use on an all-purpose fill container or a defective transmission oil cooler. Any glycol contamination requires a complete disassembly and cleanup of the transmission and replacement of seals, gaskets, clutch plates, and bearings. The vehicle cooling system should be pressure tested as a possible source of contamination.

Nelco Company offers a kit that detects presence of ethylene glycol in oil. The kit is identified as “GLY-TEK” Test Kit and can be obtained from:

Nelco Company
1047 McKnight Road South
Saint Paul, Minnesota 55119
Telephone Number: (651) 738-2014

Refer to the transmission manufacturer’s operator’s manual for additional information concerning maintenance schedules, lubrication recommendations, and inspection procedures. Have transmission serviced only by a manufacturer’s authorized service facility.

6-23.3 External Transmission Coolers

The use of external transmission coolers has become very popular with many transmission applications, especially those equipped with retarders. These components have a limited lifetime and should be considered a consumable. Customer environments with high retarder usage or high ambient temperatures are more likely to experience a shorter cooler lifetime. One of the failure modes of these coolers allows for water and coolant from the radiator to be transferred into the transmission fluids. Water and ethylene glycol can quickly deteriorate and eventually destroy the transmission. This type of transmission failure is not covered by the transmission or cooler warranty.

Daily inspections of the transmission fluid indicating a higher than normal level or showing a change to the normal physical appearance, might indicate a possible problem. Please refer to *“Transmission Fluid Analysis”* on [page 6-29](#). Pierce Manufacturing recommends you replace the cooler every 3-5 years depending on the in-service demands you put on your vehicle.

6-24. Transfer Case (*All Wheel Drive*)

Refer to the transfer case operator’s manual, included in the Pierce Service Manual, for maintenance schedules, lubrication recommendations, and inspection procedures.

Steering

6-25. Steering

6-25.1 General Inspection

WARNING

Correct any steering problems immediately. Failure to properly maintain the steering system and its components may lead to loss of vehicle control resulting in property damage, personal injury, or death.

- Ensure that drag link, tie-rod, steering arm, and pitman arm retaining nuts and clamps are tight and properly torqued.
- Check that all cotter pins are installed, spread, and not corroded.
- Inspect hoses for any signs of leaking, kinking, chafing, or corrosion.
- Maintain power steering reservoir fluid level.
- Inspect steering column joint bolts and steering linkage.
- Carefully inspect steering gear mounting bracket for signs of damage, distortion, or fatigue cracking.

6-25.2 TAK-4™ Steering

Front TAK-4™ Steering Components

Refer to the Pierce Service Manual, group 0601-P-002, TAK-4™ Steering Components and Adjustments.

Rear-Steering Rear TAK-4™ Steering Components (Optional)

Refer to the Pierce Service Manual, group 0601-P-005, TAK-4™ Rear Steering Adjustments, and group 0601-P-007 Rear Steering Components.

Non-Steering Rear TAK-4™ Steering Components (Optional)

Refer to the Pierce Service Manual, group 0601-P-006, TAK-4™ Rear Steering Components and Adjustments.

6-25.3 Steering Reservoir

The power steering pump reservoir must be kept to the proper level and free of air. When filling the reservoir, start the engine and turn the steering wheel from left to right and continue filling until proper level is maintained.

A replacement-type filter element is located in the pump reservoir. Carefully clean any buildup of dirt and grease from the reservoir cover. Remove the reservoir cover and filter element. Clean inside of reservoir with a lint-free cloth. Install a new filter element, refill with oil, and replace cover.

The filter element should be changed when the oil in the steering system is changed. TRW and Sheppard power steering gears require the use of automatic transmission fluid type “E” or “F” or TES-389 approved fluid. Highway vehicles should have the fluid changed annually or every 50,000 miles. Off-highway vehicles will require more frequent change intervals.

6-25.4 Steering System Fastener Torque

Inspect all steering system fasteners and tighten as required to the torque specified in [Table 6-6](#) or [Table 6-7](#).

Table 6-6: Steering System Fastener Torque Chart - except TAK-4™

Component	Location	Fastener Size	Torque	
			Ft-Lbs	N-m
Steering Gear - Arrow XT™/Velocity™/Impel™	Top bolt securing the steering gear to the bracket.	7/8 - 14 UNF	635	860
Steering Gear - Arrow XT™/Velocity™/Impel™	Six lower bolts securing the steering gear to the bracket.	3/4 - 16 UNF	398	539
Steering Gear - Arrow XT™/Velocity™/Impel™	Four-Bolt pattern securing steering gear bracket to frame.	3/4-10 UNC	357	484
Steering Gear - Arrow XT™/Velocity™/Impel™	Six bolt pattern securing steering gear to bracket.	3/4-16 UNF	398	539
Steering Gear - Arrow XT™/Velocity™/Impel™	Lower bolt securing steering gear to bracket.	7/8-14 UNF	635	860
Steering Shaft Gear Box	Bolts securing 90-degree steering shaft gear box to the cab.	3/8 - 16 UNC	44	60
Steering Shafts	Keyway and spline clamp bolts.	3/8 - 24 UNF	48	65
Pitman Arm	Clamp bolt.	3/4 - 10 UNC	226	306
Drag Link	Clamp bolts.	5/8 - 11 UNC	125	169
Drag Link	Ball joint nuts.	7/8 - 14 UNF	150	205
Steering Assist Cylinder	Ball joint nuts.	7/8 - 14 UNF	150	205
Steering Assist Cylinder	Clamp bolts.	5/8 - 11 UNC	125	169
Steering Wheel	Center nut.		60	85

Table 6-7: Steering System Fastener Torque Chart - TAK-4™*

Component	Location	Fastener Size	Torque	
			Ft-Lbs	N-m
Steering Shafts	Keyway and spline clamp bolts.	3/8 - 24 UNF	48	65
Steering Wheel	Center nut.		60	85

* additional Front TAK-4™ torque specifications can be found in the Pierce Service Manual, Front Axle & Suspension Chapters.

* additional Rear TAK-4™ torque specifications can be found in the Pierce Service Manual, Rear Axle & Suspension Chapters.

6-25.5 ALL STEER® All-Wheel Steering (Optional)

Refer to the Oshkosh ALL STEER® service group, 0611-P-001 (included in the Pierce Service Manual), for maintenance schedules, lubrication recommendations, and inspection procedures.

Towing

6-26. Towing Instructions

⚠ WARNING

Due to the many variables that exist in towing, positioning, attaching, and lifting of the vehicle - towing is the sole responsibility of the towing-vehicle operator who must be familiar with standard towing industry safety measures. Failure to follow standard industry safety measures may lead to property damage, personal injury, or death.

CAUTION

Towing of a vehicle equipped with an automatic transmission even in neutral for even short distances may cause serious damage to the transmission components.

NOTE: The towing vehicle used to develop this procedure was a Jerr-Dan[®], Model HDL1000/565 50 Ton Wrecker (Integrated).

6-26.1 Preparation for Towing

1. Block the wheels and ensure that the personnel working around the vehicle will be safe from oncoming traffic.
2. Unload equipment when practical to reduce abnormal loads exerted on the chassis components caused by the towing process.
3. Drain all water from the water tank.

6-26.2 Front Towing

1. Single rear axle vehicle: Remove the rear-most driveshaft.
Tandem rear axle vehicle: Remove axle shafts and cover the ends of the axles with metal plates or plywood cut to fit the axle opening and drilled to fit the axle shaft studs. This prevents lubricant from leaking out and contaminants from getting in.
2. Remove the front bumper extension and stainless steel bumper or attach in a manner that prevents damage to these components.
3. Remove any water pipes, air intake pipes, or accessories that may be damaged during the towing hook up procedure or during transit.
4. Attach the towing device.

⚠ WARNING

Before releasing the parking brakes, secure the connection to the towing vehicle or block the wheels, or loss of vehicle control may cause property damage, personal injury or death.

5. Manually release the parking brakes or release the parking brake button and supply the air brake system with a constant source of air pressure to ensure that the spring brakes remain released during the towing process.

Additional considerations when towing a Custom Chassis tractor/aerial tiller combination:

- Ensure the rear tiller steering is locked out by inserting the steering column lock pin in the steering lockout hole.
- To minimize the possibility of damage to the tractor, the front tires should be lifted only as high as necessary to facilitate towing.

6-26.3 Rear Towing

1. Position the front tires straight ahead and secure the steering wheel in this position.
2. Remove any water pipes or accessories that may be damaged during the towing hook up procedure or during transit.
3. Attach the towing device.

6-26.4 Tow Hooks and Tow Eyes

WARNING

Tow hooks are designed to assist in pulling vehicles for short distance on flat and level surfaces. The hooks and mounting structures are designed based on the GVW of the vehicle and its rolling resistance on level ground. Vehicles stuck in off road conditions, on down-slopes, or in ditches can exert much higher forces on the tow hooks than they are designed to withstand. Towing or pulling in these conditions must be accomplished by experienced towing personnel with attachments to main structural members of the vehicle such as axles or frame rails. Towing safety is the sole responsibility of the towing-vehicle operator who must be familiar with standard towing industry safety measures. Use of tow hooks beyond their safe design limits as stated above may cause serious property damage, personal injury, or death.

CAUTION

Tow hooks are provided to assist in pulling the vehicle from directly in front of, or directly behind the vehicle; with all wheels in contact with the ground. Do not lift and tow vehicle from the tow hooks, front bumper extension, or rear platform. Failure to observe these cautions may cause serious property damage.

Tow hooks and tow eyes may be found on the front or rear of many Pierce apparatus. The specific location will vary based on the options selected. These tow eyes and tow hooks may be used for towing disabled vehicles for short distances on flat and level surfaces in an emergency. They are not meant for long distance towing on public highways.

6-26.5 TAK-4™ Front Suspension Towing

CAUTION

Towing of a vehicle equipped with the TAK-4™ front suspension by attaching to or lifting by any component or structure of the TAK-4™ assembly may result in damage to these components or assembly.

With some configurations of TAK-4™ equipped apparatus, towing will not be possible with the available equipment provided through local towing services. Pierce Manufacturing recommends using the tire lift method for towing TAK-4™; however in many cases the lift system, the truck configuration, or both are not rated for the vehicle's weight on the front axle. In the case of platform aerials, the reach required for the lift device may degrade the device's lifting capability to the point that towing is not possible.

6-26.6 TAK-4® T3 Rear Steering Axle Towing

CAUTION

Oshkosh® TAK-4® T3 rear-steering system is a mechanical all-wheel steering system. All wheels must be allowed to steer together when towing, or the steering system must be disconnected prior to towing. Failure to comply will cause damage to equipment.

Caution must be used when towing a truck equipped with Oshkosh® TAK-4® T3 rear steering system to avoid causing damage to the steering system. If a tire-lifting device is used to transport the truck using the front wheels, the front wheels will be locked yet the rear wheels will remain free to turn. This will cause resistance in the steering system resulting in the steering dwell mechanism's shear pin to shear, requiring the steering dwell mechanism to be replaced.

TAK-4 T3 trucks may be towed one of three ways:

- Using a flat bed trailer.
- Using the front underbody frame forks (if equipped).
- Using a front tire-lifting device. If this method is used, the front wheels will be locked in place with the lifting device, but the rear wheels will still be able to steer against the resistance. The steering dwell mechanism must be disconnected to prevent damage.

Preparing to Tow a TAK-4 T3 Equipped Vehicle Using a Front Tire Lift Device

To tow with a front tire lifting device, the steering dwell mechanism must be disconnected at the input shaft. This method will require the steering system to be re-timed before the vehicle is placed back into service. Refer to the vehicle service manual for steering timing procedure.

Figure 6-8: Dwell Mechanism

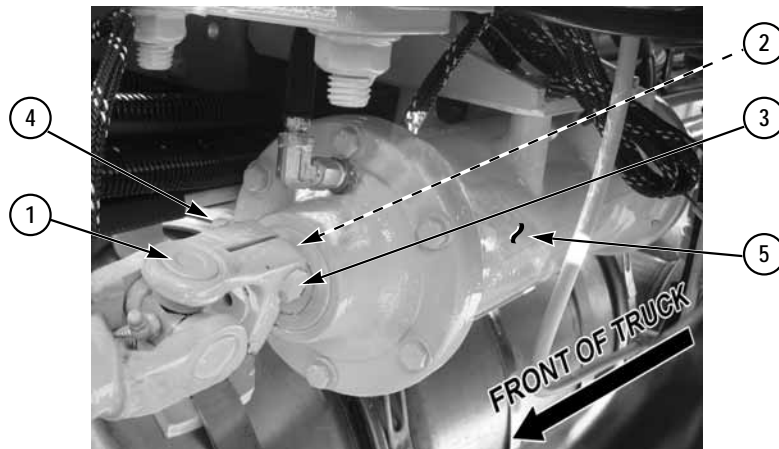

NOTE: Disconnect input shaft of dwell mechanism only (towards front of truck). Disconnecting the rear shaft will create additional steps in re-timing the steering system.

1. Center the steering wheel.

NOTE: Match marking is not necessary, but may serve as a secondary verification during re-timing.

2. Match mark steering shaft (1) and dwell mechanism front input shaft (2).
3. Remove screw (3) and nut (4) and remove steering shaft (1) from dwell mechanism (5).
4. Support steering shaft for transport.
5. Before placing the vehicle back into service, re-time the steering system. Refer to "TAK-4 Rear Steering Adjustments," Group 0601-P-005, in the vehicle service manual.

6-26.7 Tire Lift Method (*Preferred*)

CAUTION

Special precautions are necessary when using the tire lift method on a TAK-4 T3 equipped truck in order to prevent damage to the steering system. See *"TAK-4® T3 Rear Steering Axle Towing"* on page 6-35.

A typical Pierce Custom Chassis can be towed using an 138 inch underlift reach. Aerial Platforms should be towed with at least an 177 inch underlift reach. Ensure there will be enough clearance between the towing vehicle and components on the disabled vehicle to turn while being towed. Failure to comply may result in damage to equipment.

IMPORTANT: Tire lift attachment should have a minimum capacity rating of 25,000 lbs.

Figure 6-9: Underlift Device using Tire Lift Brackets



1253

On trucks equipped with TAK-4™ independent front suspension, lift the front of the disabled vehicle using an underlift device with proper tire lift brackets that support and secure the front tires (*Figure 6-9*). Do not lift the front of the disabled vehicle by attaching to or lifting by any component or structure of the TAK-4™ suspension.

Figure 6-10: Safety Chains and Tire Straps



1254, 1255

Before transporting the disabled vehicle, ensure that safety chains and tire straps are properly installed and secure (Figure 6-10).

6-26.8 Lift and Tow using Frame Forks

NOTE: Tow forks with a minimum of 6.50" spread between tines are required (Jerr-Dan P/N 3-454-000057).

Arrow XT™ chassis can be lifted and towed using a standard under-lift device equipped with heavy duty frame forks. This is a third towing alternative, in addition to tire lift and flatbed transport. When lifting and towing using frame forks positioned in the disabled vehicles lift and tow saddle brackets, care must be taken to ensure that no damage to the chassis occurs. Securing the disabled vehicle to the tow vehicle may require some disassembly and is the responsibility of the tow vehicle operator. Pierce Manufacturing does not warranty any damage that may occur due to improper towing.

Figure 6-11: Lift and Tow Saddle Brackets with Integral Tow Eye



1256, 1257

A lift and tow saddle bracket, including an integral tow eye, is located beneath the left and right side frame rail extension (Figure 6-11).

6-26.8a General Procedure

Figure 6-12: Frame Fork Adapters, Crossbar & Frame Forks

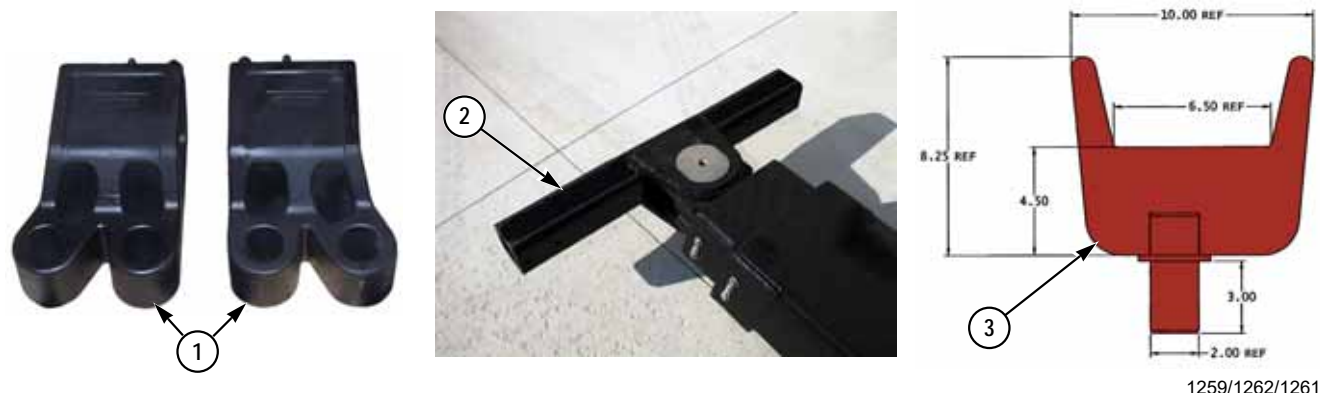

1. Install the frame fork adapters (1) (Jerr-Dan® P/N's 7-007-000055 & 7-007-000056) to the crossbar (2) (Figure 6-12).
2. Install the frame forks (3) (Jerr-Dan® P/N 3-454-000057) in the frame fork adapters (1) (Figure 6-12).

Figure 6-13: Under Lift Towing Fork Positioning & Securing

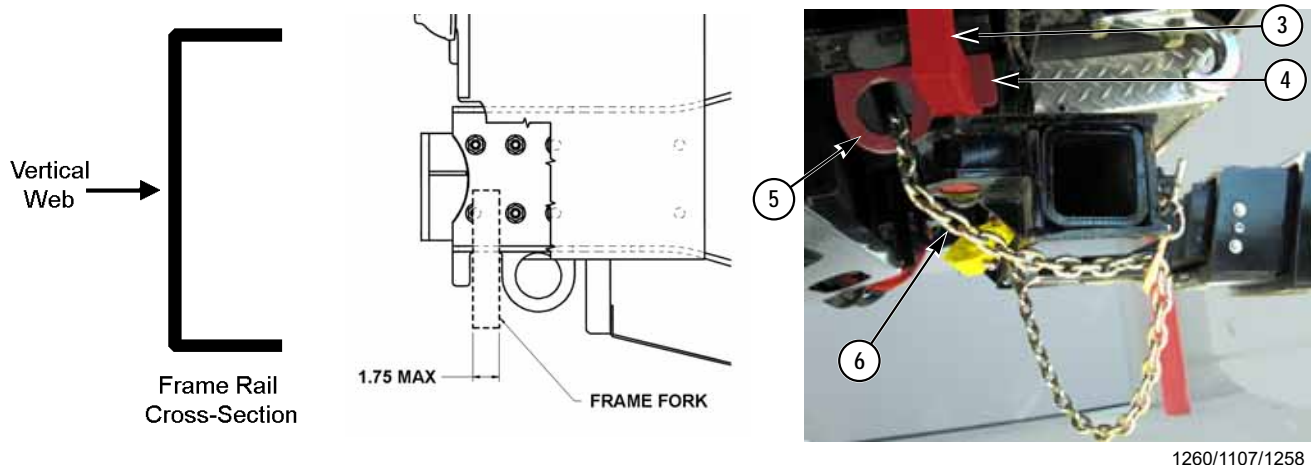

3. Move the crossbar (2) under the front of the truck locating the frame forks (3) under the lift and tow saddle brackets.

IMPORTANT: The frame forks posts are off-set. The post on the bottom of the fork should be positioned closest to the vertical web of the frame rail.

4. Raise the crossbar and position the frame forks in the opening of the lift and tow saddle brackets (4) just ahead of the tow eye (5) (Figure 6-13).
5. Safety chains (6) should be installed to the frame fork adapters and through the frame fork tow eyes (Figure 6-13).
6. Make sure the crossbar is secure. Lift the truck and tow carefully.

Welding

6-27. Welding Instructions

CAUTION

Welding on a truck may cause voltage surges to be distributed throughout the truck's electrical system. Electronic components, which are connected to the electrical system, may be damaged due to these high voltage surges. Electronic components may fail at relatively low voltages caused by a brief welding operation done on the truck.

Before any welding is done on a multiplexed unit, make sure ALL electronic modules and control units (ECUs) are disconnected. Refer to the Pierce Service Manual, group 0950-P-008, ECU, PMC, and Power Module Location Guidelines, and the applicable multiplex documentation for component locations. Also be sure to disconnect the following, as applicable: engine ECU, transmission ECU, anti-lock brake system ECU, ALL STEER[®] all-wheel steering ECU.

6-27.1 Welding on Frames

WARNING

Do not weld on heat-treated frame rails or frame failure leading to property damage, personal injury, or death may result.

All Pierce Custom Chassis frames are manufactured from high strength heat-treated steel that will lose its strength when welded upon. Do not weld on frame rails.

6-27.2 Before Welding

This section defines the requirements for disconnecting electronic components before all welding operations. Before welding, disconnect all electronic components listed in [Table 6-8](#). Special electrical system configurations may include additional electronic control units that may require disconnection before welding on the vehicle. Most electronic component connectors that require disconnection when welding on the vehicle are identified by a "Connector Disconnect Tag" (P/N 91-0250).

Figure 6-14: Connector Disconnect Tag



91-0250

Table 6-8: Electronic Components Disconnect Table (Before Welding)

Before any welding can be done on this unit, you MUST disconnect the following.	
Detroit DDEC	Disconnect the three tagged plugs that are on the Detroit ECU. Located on the driver side of the engine on Series 60 and Series 50.
BOSCH or WABCO ABS	Disconnect the tagged plug that attaches to the Bosch or Wabco ECU. <u>ABS ECU locations:</u> <ul style="list-style-type: none"> • Arrow XT™ - in the PMC box in the dash. • Arrow XT™ with Command Zone™ - on chassis crossmember or under center tunnel cover.
CUMMINS ISM/ISC	Disconnect plugs on the Cummins C83 Electronic Engine. Located on the Cummins ISC engine.
ALLISON TRANSMISSION	Disconnect plugs on the Allison Transmission Control Module (TCM). <u>Allison Transmission TCM locations:</u> <ul style="list-style-type: none"> • Arrow XT™ - on backside of brake cover. • Arrow XT™ with Command Zone™ - in the first officer side front distribution enclosure.
FOAM PRO FOAM SYSTEM	All parts of the “Foam Pro” system must be disconnected before welding. This includes the positive and negative battery cable and vendor-supplied cable to the pump and gauges.
ALL STEER® ALL-WHEEL STEER ECU	AWS I: Disconnect both plugs on the ECU. Located in the cab. AWS II: Disconnect the VIM. Located inside the first officer side frame rail, just in front of the rear axle.
ALL FLASHERS	Check electrical layouts for locations.
SIDE ROLL PROTECTION	Disconnect both connectors from the Master Roll Sensor and the Slave Roll Sensor (if installed).
COMMAND ZONE™	If TIG welding on a Command Zone™ truck, all Command Zone™ modules must be disconnected.

Figure 6-15: Side Roll Protection and Frontal Impact Connectors



1390

6-27.3 Battery System Protection

With the Battery Switch ON and the cab raised:

1. Connect the Positive and Negative clamps of the Anti-Zap Device across the driver side battery terminals.
2. Repeat this procedure on the passenger side of the truck with a second Anti-Zap Device.
3. If there is an isolated battery on the truck, then you must also connect a third Anti-Zap across its battery terminals.
4. Make sure the green indicator is ON and the red indicator is OFF for each of the devices.
5. Turn OFF the Battery Switch.

Figure 6-16: Connecting the Anti-Zap Device



1395

6-27.4 After Welding

Electronic components listed in [Table 6-8](#) can be reconnected after all welding is completed.

Wheels and Tires

6-28. Tires

6-28.1 Fire Service Rated Tires

⚠ WARNING

Never load a tire beyond its rated capacity or sudden tire failure leading to a loss of vehicle control, property damage, personal injury, or death may result.

This vehicle may be equipped with fire-service rated tires. Tire may fail if driven continuously at highway speeds. Keep tires properly inflated. Follow the instructions in this manual to avoid degrading tire material. Crash caused by tire failure may injure or kill.

Fire apparatus axle loads are often higher than typical vocational trucks. Tire manufacturers recognize the need for fire apparatus to carry higher loads, but also understand that in most cases a fire apparatus does not travel at high speeds for long periods of time. Most apparatus on a fire call travel only a short distance, and then they idle for extended periods.

Based on this duty cycle, tire manufacturers are willing to rate some of their tires with a special “fire service” intermittent duty rating. This allows the tire to carry greater loads or attain higher speeds. The understanding is that these high loads and speeds will not be sustained for long periods of time.

The reason tire manufacturers are able to provide this intermittent rating is that a tire used over short distances does not have a chance to heat up. A tire's worst enemy is heat. Heat is generated by the flexing of the rubber inside the carcass. This heat builds up over time and will degrade the rubber, eventually leading to a greater risk of tire failure. This heat build-up happens more quickly when the tire is driven faster, or when it carries more load.

To avoid tire degradation, fire-service rated tires have limits on the amount of time they can be driven at high speed and high load before they must cool-down.

6-28.2 Fire Service Ratings

There are two cases where intermittent fire service ratings can apply, extra load and extra speed:

- Extra Load: In this case the tire is allowed to carry extra load, higher than the standard rating.
- Extra Speed: In this case the tire is allowed to attain higher speeds than the standard maximum speed rating.

A fire-service rated tire can carry extra load, or attain higher speeds, but not always both at the same time.

You can determine if your tires are being operated under a fire service rating by checking the maximum load rating listed on the sidewall of the tire. Find the gross axle weight rating (GAWR) on the yellow final vehicle manufacturer label in the cab. Divide each GAWR rating by the number of tires on that axle. If the GAWR rating divided by its tires is greater than the sidewall rating for the tire, then your tire is operating in a fire-service condition.

6-28.3 Fire Service Rating Rules

Tires in a fire service condition must only be operated using the following rules:

6-28.3a Goodyear Fire-Service Rating Rules

After driving for 50 miles at speeds above 50 mph, stop for 20 minutes or reduce speed to 50 mph for 20 minutes to allow the tire carcass to cool.

6-28.3b Michelin Fire-Service Rating Rules

After driving for 1 hour at speeds above the standard maximum rated speeds, or at loads over the maximum sidewall rating, park the apparatus for 1 hour to allow the tire carcass to cool.

6-28.4 Tire Inflation

⚠ WARNING

Maintain tire pressure at the tire manufacturer's pressure recommendations for the correct tire size, type, load range (ply rating), and measured in-service axle load of the vehicle. Failure to maintain proper tire pressure may result in loss of vehicle control, property damage, personal injury, or death.

Consult tire manufacturer's load and inflation tables for proper inflation pressures at a given in-service axle weight. Maximum inflation pressures, either published or special fire service recommendations, are only to be used on axles at or near the maximum rated capacity. Also follow the load and inflation tables for axles at less than maximum capacity.

The maximum tire pressure may be limited by the tire capacity (as stated on the side wall) or by the wheel capacity. Do not assume that the tire can be safely operated at the maximum pressure as stated on the sidewall since the wheel may be the limiting factor. Refer to the maximum tire pressure listed on the yellow Federal Motor Vehicle Safety Standard (FMVSS) information decal, located in the cab, for maximum tire pressure ratings.

Guidelines provided are based on tires that are inflated to the correct pressure. Proper tire pressure is always important, but it is critically important if tires are being employed in fire-service rated conditions.

Table 6-9 is for Michelin® tires only. For Goodyear tires see the Pierce Service Manual, group 0655-V-001, Goodyear Load Inflation Guide, or refer to the tire data book that matches the brand of tire on your vehicle.

Table 6-9: Tire Data Chart

WHEEL DIAMETER - 22.5"

11R22.5 LRH – ALL TIRES

PSI		75	80	85	90	95	100	105	110	115
lbs. per axle	S	9385	9900	10430	10940	11510	12350	12490	12855	13220
	D	16895	17820	18770	19690	20720	22700	23110	23520	23800
kg per axle	S	4257	4491	4731	4962	5221	5602	5665	5831	6000
	D	7664	8083	8514	8931	9399	10297	10483	10669	10800

12R22.5 LRH – ALL TIRES

PSI		75	80	85	90	95	100	105	110	115
lbs. per axle	S	9980	10560	11140	11740	12310	12910	13480	14060	14780
	D	17700	18700	19800	20800	22000	23200	24400	25600	27000 (1)
kg per axle	S	4527	4790	5053	5325	5584	5856	6115	6378	6700
	D	8029	8482	8981	9435	9979	10524	11068	11612	12250

(1) Except 12R22.5 XDN26440 (D)

315/80R22.5 LRL – ALL TIRES

PSI		75	80	85	90	95	100	105	110	115	120	125	130
lbs. per axle	S	11700	12280	12870	13350	13990	14620	15260	15900	16540	16970	17500	18000
	D	19190	20420	21650	23120	24220	25320	26420	27540	28640	30240	31570	33020
kg per axle	S	5542	5763	5984	6056	6346	6632	6922	7212	7503	7698	7938	8165
	D	9265	9717	10169	10487	10986	11485	11984	12492	12991	13717	14320	14980

385/65R22.5 LRJ – ALL TIRES

PSI		75	80	85	90	95	100	105	110	115	120	125
lbs. per axle	S	12665	13280	13880	14560	15160	15780	16440	17060	17800	18300	18740
	D											
kg per axle	S	5745	6024	6296	6604	6877	7158	7457	7738	8000	8301	8500
	D											

425/65R22.5 LRL – ALL TIRES

PSI		75	80	85	90	95	100	105	110	115	120	125
lbs. per axle	S	15340	16000	16800	17680	18440	19180	20000	21000	21480	22220	22800
	D											
kg per axle	S	6958	7258	7620	8020	8364	8700	9072	9526	9743	10079	10300
	D											

445/65R22.5 LRL (2) – XZY®

PSI		75	80	85	90	95	100	105	110	115	120	125	130
lbs. per axle	S	16065	16930	17700	18660	19560	20480	21310	22140	22980	23890	24640	25600
	D												
kg per axle	S	7286	7679	8027	8463	8871	9288	9664	10041	10422	10834	11175	11600
	D												

S = Single configuration – 2 tires per axle

D = Dual configuration – 4 tires per axle

Proper inflation is vital! Under inflation is a tire’s worst enemy. Inflation pressure should be checked with an accurate tire pressure gauge only. “Thumping” with a tire bar is not a satisfactory method to use when checking pressure.

The practice of reducing inflation pressure to attain a softer ride is extremely hazardous, especially when steer axle tires are involved. Under inflation causes excessive flexing within a tire, resulting in heat buildup which can cause a blowout. An under inflated tire running at highway speeds and under heavy load can cause severe handling problems.

Under inflation can also result in general deterioration of the tire body, including separation of the tread from the body or fatigue breaks in the body cords. If one tire on a dual assembly is severely under inflated, the other one is prone to failure from overloading.

Over inflation detracts from a tire's ability to endure road shocks. The tire is more rigid, resulting in carcass and bead failures. Overinflated tires often exhibit groove cracking and rapid center tread wear, and are more likely to be cut or punctured.

Excessive pressure buildup resulting from overloading or high speed can cause the rim to fail. The load-carrying capacity of a tire cannot be increased over the maximum rated load by increasing the inflation pressure.

A tire that has become hot from normal use will have a higher pressure than it will when cool. Never bleed pressure from a hot tire that has increased pressure as a result of the normal pressure buildup. Always check tire pressure when the tire is cold.

6-28.5 Matching

Match dual tires so that tires worn to the same diameter are placed together. Do not mount tires together that vary by more than 1/4 inch in diameter or 3/4 inch in circumference.

Match dual tires on tandem axles as directed above, but do not place the four largest tires on one axle as this may cause high axle oil temperatures and reduced axle life.

For 4x4 chassis, match front drive tires to the rear axle tires so that the rolling radius does not create a ratio difference between front and rear axles.

6-28.6 Tire Wear Inspection

WARNING

Never operate a vehicle without sufficient tire tread depth, or loss of vehicle control, property damage, personal injury, or death may result.

Inspect tires for signs of abnormal or excessive wear. Sufficient tread depth is essential to proper handling and braking performance. Refer to the tire manufacturer's owner's manual for minimum tread depth requirements. Replace tires before minimum tread depth is reached.

Tire tread life is dependent on many factors including the following:

- Tire load
- Proper inflation pressure
- Tire footprint (area of rubber in contact with the road)
- Frequency of dry-steer maneuvers (steering the vehicle in the absence of forward motion)
- Tandem scrub (inherent to all non-steering tandem suspensions)
- Engine horsepower
- Brake power
- Frequency of tight cornering maneuvers
- Driving habits of acceleration and braking
- Suspension alignment

Expect faster tread wear on fire apparatus when compared to standard line-haul trucks. Fire apparatus accelerate faster, brake harder, corner tighter, and have more horsepower flowing through the tires to the road than other heavy-duty trucks with the possible exception of waste haulers. Tandem axle aerial apparatus are particularly susceptible to accelerated tire wear due to the combination of the tandem scrub phenomenon and high suspension

loading. Over-the-road tractor tandems do not exceed 34,000 pounds loading; whereas typical aerial apparatus tandems may be loaded from 44,000 pounds to 58,000 pounds or higher. Since most aerial apparatus only operate in congested areas with taller buildings, it is natural that they will experience a much greater proportion of their time in accelerating, braking, and cornering – three of the most detrimental influences on tire life.

While the steering action of the ALL STEER[®] all-wheel steering option will reduce the negative influence of tandem scrub when cornering, this advantage can be offset if the vehicle is subjected to dry-steer or crab-steer operation. The single tires on the ALL STEER[®] axle are also subjected to a higher load per footprint area and will naturally tend to wear faster than will dual tires at the same loading.

6-28.7 Tire Rotation

NOTE: When rotating tires with Counteract balancing beads, the technician should strike the tire tread to dislodge the beads to promote rebalancing in the new axle position. See *“Balancing”* on [page 6-47](#).

Front Tires

If irregular tire wear is found on the front axle tires, they should be moved to the rear axle position (if same size and tread pattern) or replaced.

Rear Tires

If irregular wear such as heel and toe or alternate lug wear occurs, the tires should be rotated to reverse the rotation of the tires. In tandem axle units, swap the right rear tire pair with the left front pair, keeping the outside tires in the outside position. Swap left rear and right front pairs in the same manner.

6-28.8 Balancing

Wheel and tire assemblies should be balanced to avoid vibration or shimmy during road operation. Pierce balances all tires and wheels by adding Counteract balancing beads to the tire/wheel during assembly. Once the balancing beads are installed inside the tire, it is not possible to see them; no lead weights are used.

The beads automatically balance the complete wheel assembly as the tire rotates. The beads balance not only the tire and wheel, but also the hub and brake assembly of the axle.

The beads continually adjust to changes on the tire and wheel to maintain balance. As the tire wears, the beads will adjust properly so the assembly is always in balance. The beads will also adjust if tires become out of balance due to mud in the tire tread or stuck to the wheel.

6-28.9 Tire Pressure Management Sensors

NOTE: The tire must be inflated to the correct pressure before installing the tire sensor valve cap to calibrate and ensure proper operation.

If replacing a defective valve cap, inflate tire to the proper operating pressure (see *“Tire Inflation”* on [page 6-44](#)) and install the new sensor on the valve stem.

See Tire Pressure Management System in the Operation chapter of this manual, and “LED Air Guard Tire Pressure Monitoring System”, Group 0670-V-003 in the vehicle Service Manual for more information.

6-28.10 Emissions Related Tire Warranty

Oshkosh Corporation in conformance with 40CFR§1037.120 warrants to the ultimate purchaser and each subsequent purchaser that the tires delivered with this new vehicle will be free from defects in materials and workmanship that cause the vehicle to fail to conform to the requirements of 40CFR§1037 Control of Emissions from New Heavy-Duty Motor Vehicles for 2 years or 24,000 miles.

6-28.11 Tire Replacement Information

NOTE: The rolling resistance of the tires on a vehicle contribute to the overall load on the engine, and therefore can impact the level of emissions produced by the vehicle. The tires on your vehicle have been selected by the Original Equipment Manufacturer (OEM) to conform to the requirements of this law. Tires which have a higher rolling resistance than the original equipment can impact the emissions of the drive engine and cause the vehicle to fall out of compliance with the law.

To maintain emissions compliance the tires on this new vehicle must be replaced only with tires of equal or lower rolling resistance than those originally supplied with the vehicle. Contact your tire manufacturer to determine the correct replacement tire.

6-29. Wheels

6-29.1 Bearings

Inspect wheel bearings in accordance with the axle manufacturer's recommended schedule. Use inspection procedures found in the axle manufacturer's maintenance manuals.

6-29.2 Wheel Installation – General

⚠ WARNING

Improper installation methods or component selection can cause loss of torque, broken studs, or cracked wheels. Improperly seated wheels can run loose, cause stud breakage, or disengage from the vehicle. Any of these problems may lead to loss of vehicle control, serious property damage, personal injury, or death.

Wheel nuts must be checked for proper torque after the first 50 to 100 miles of service, then frequently as part of periodic maintenance. Failure to verify wheel nut torque may lead to loss of vehicle control, serious property damage, personal injury, or death.

Proper installation of rims and wheels on a vehicle is essential to safe, economical, trouble-free service. Use only the specified sizes of studs, nuts, and clamps. Check all parts for damage, including wheels and rims. Ensure that studs, nuts, and mounting faces of hub and wheels are sound, clean, and free from grease. Clean hub surfaces with wire brush if scale is present. Do not lubricate wheel studs. Replace any damaged parts.

Consult wheel manufacturer's installation procedures for detailed instructions and replacement part recommendations.

6-29.3 Hub Piloted Wheel Installation

WARNING

Hubs designed for steel hub piloted wheels may not have sufficient depth or stud length to properly accommodate aluminum wheels. Installation of hub piloted wheels on a hub with insufficient pilot depth or stud length may cause wheel assembly failure leading to loss of vehicle control, personal injury, or death.

1. Slide front wheel or inner rear wheel over studs, being careful not to damage stud threads.
2. Slide outer rear wheel over studs.
3. Snug up flange nuts alternately in the sequence shown. Rotate wheel assembly one-half turn to allow the wheel to seat. DO NOT tighten them fully until all have been seated. This procedure will permit the uniform seating of nuts and ensure the even, face-to-face contact of wheels and hub.

Figure 6-17: Wheel Nut Tightening Sequences

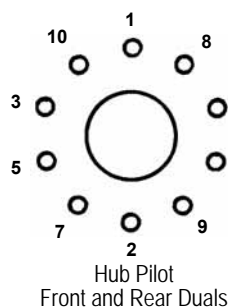

POM0115

Table 6-10: Wheel Nut Torque Chart

Mounting	Thread Size	Torque
		Ft-Lbs (Dry)
10 Hole, 285.75 mm – Hub Piloted	M22 x 1.5	450–500
10 Hole, 285.75 mm – Hub Piloted with Meritor ADB 1560 disc brakes	M22 x 1.5	390–450

4. Tighten flange nuts fully, using the same alternating sequence. In each case, be sure to tighten wheel nuts only to the torque level recommended in the table and to maintain them at that level through planned, periodic checks.
5. Check torque on wheel nuts after the first 50 to 100 miles of service.

6-29.4 Stud Piloted Wheel Installation (Optional)

1. Mount wheel or inner dual wheel over studs, being careful not to damage stud threads.
2. Spin on the outer cap nuts on the front wheel, or inner cap nut on the rear wheel.

Figure 6-18: Wheel Nut Tightening Sequences

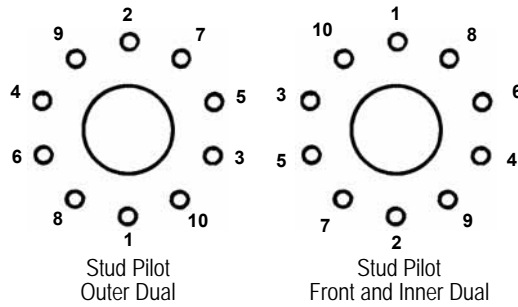

POM0115

3. Snug up nuts alternately in the sequence shown. DO NOT tighten them fully until all have been seated. This procedure will permit the uniform seating of nuts and ensure the even, face-to-face contact of wheels and hub.
4. Tighten nuts fully per the values listed in the Torque Chart using a calibrated torque wrench and following the same alternating sequence.
5. Mount the outer rear wheel and repeat the entire procedure. In each case, be sure to tighten wheel nuts only to the torque level recommended in the table and to maintain them at that level through planned, periodic checks.

WARNING

Never check torque on a fastener that has already been tightened. This will give a false torque reading. To obtain the correct torque on a fastener that has already been tightened, break the fastener loose and then retighten to the appropriate torque.

NOTE: Whenever the outer cap nut is loosened, always loosen and retighten the inner cap nut before torquing the outer cap nut.

6. Check torque on wheel nuts, including inner cap nuts on duals after the first 50 to 100 miles of service. When inner cap nuts are tightened, be sure to first loosen outer cap nuts several turns, loosen and retighten inner cap nuts and then tighten outer cap nuts. Torque to recommended levels as specified in [Table 6-11](#). To avoid losing the seating of the outer wheel when checking the inner wheel torque, first loosen alternate outer nuts. Then tighten the inner nuts and retighten the outer nuts. Then loosen the remaining outer nuts, tighten the inner nuts, and retighten the outer nuts.

Table 6-11: Wheel Nut Torque Chart

Mounting	Thread Size	Torque
		Ft-Lbs (Dry)
10 Hole, 11.25 inch – Stud Piloted	3/4-16	450–500
10 Hole, 11.25 inch – Stud Piloted	1-1/8-16	450–500

6-29.5 Cast Spoke Wheels (Optional)

Installation

Figure 6-19: Cross-Section of Cast Spoke Wheel

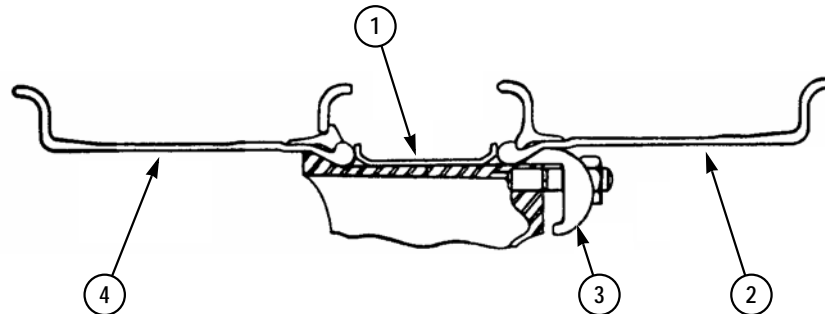

POM0116

Item #	Description
1.	Spacer Band
2.	Outer Dual Rim
3.	Rear Clamp
4.	Inside Rim

NOTE: All 8.5-5 rims require special size hubs and spacer bands.

1. Place the inside rim (4) over the cast spoke wheel as far as possible.
2. Push the spacer band (1) over the cast spoke wheel with constant pressure on both sides. Guard against cocking.
3. Place the outer dual rim (2) in position.

Figure 6-20: Cast Spoke Wheel Nut Tightening Sequence

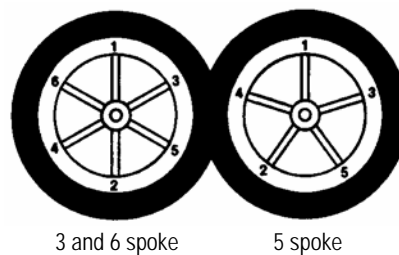

3 and 6 spoke

5 spoke

POM0117

4. Align the valve locators between the spokes. Secure clamps (3) evenly in position. Snug up nuts in the sequence shown. Do not tighten nuts fully.
5. After the nuts are properly seated and the rim is centered on the spoke wheel, tighten the nuts one-quarter turn at a time in the criss-cross sequence until they are tightened to 200-260 ft-lbs. This will permit the rims to properly align themselves on the 28° mounting surfaces of the cast spoke wheel.
6. If the heel of the rear clamp touches the spoke before reaching 80% of the recommended torque level, check to be sure that the proper clamps and spacer bands are being used.

Wheel Torque

CAUTION

Demountable rims are not all the same offset. Use the proper size tires, rims, spacer bands, and clamps to get adequate dual spacing and vehicle clearance.

1. Be sure to tighten wheel nuts to the recommended torque. Do not overtighten.
2. After the first 50 to 100 miles of operation, recheck the torque levels and retighten nuts to the proper torque level.
3. Maintain the nut torque at the recommended level through planned, periodic checks or at 10,000-mile intervals, whichever comes first. Individual fleet experience may dictate shorter intervals or allow for longer intervals.
4. If air wrenches are used, they must be periodically calibrated for proper torque output. Use a manual torque wrench to check the air wrench output and adjust the line pressure accordingly to give the correct torque.

6-29.6 Aluminum Rear Disc Wheels with Flange Nuts (Hub Piloted)

Prior to reinstalling rear aluminum hub-piloted wheels, clean each wheel locator pad on the hub of all dirt, rust and foreign material. Apply a light coat of chassis grease or never seize.

6-29.7 Rim and Wheel Inspection

WARNING

Wheels and rims are manufactured with capacity ratings based on maximum tire pressure and load. Inflate tires to only the recommended air pressure, being sure not to exceed the rim/wheel inflation rating. Failure to observe these precautions may cause wheel damage leading to loss of vehicle control, serious property damage, personal injury or death.

Inspect wheels during all pre-trip inspections and at periodic maintenance intervals depending upon road and environmental conditions of operation.

Check all metal surfaces thoroughly while making tire inspections, including areas between duals and on inboard side of wheel. Watch for:

- Excessive rust or corrosion buildup;
- Cracks in metal;
- Bent flanges;
- Deep rim tool marks on rings or in gutter areas;
- Loose, missing, or damaged nuts or clamps;
- Bent or stripped studs;
- Severe marring or gouging beneath fasteners;
- Damaged or missing rim valve-locator plates;
- Incorrectly matched rim parts.

Mark damaged or broken areas, when seen, so that rim will be removed from service at the first opportunity. Replace the assembly that has damaged rims or wheels. Determine the cause of the damage before installing another wheel or rim. If nuts are found to require frequent tightening, studs break frequently, or wheel bolt holes become damaged, review hardware and mounting practices to determine cause.



Scheduled Inspections

7-1. Introduction



Refer to the following charts for service and lubrication requirements. Perform services at the indicated interval of miles or time, whichever comes first.

NOTE: The services and inspections intervals in this section cover the Pierce vehicle in its basic or most common form. Because custom chassis are built with a variety of components from different vendors, be sure to refer to the inspection or service documentation for those vendor components installed on your vehicle. Many of these vendor documents can be found in the Pierce Service Manual.

7-1.1 Initial Inspection Upon Delivery

Initial Preventative Maintenance, Checks, and Services			
System/Component	Action	Miles	Alternate As Indicated
Spring U-Bolts	Check torque and tighten as required (after initial delivery).	500	Initial Inspection
Comments or Additional Items			

LUBRICATION AND MAINTENANCE INTERVALS

7-1.2 Daily Inspections

Daily Preventative Maintenance, Checks, and Services			
System/Component	Action	Standard Interval	Alternate As Indicated
Air Cleaner	Check air intake restriction indicator.	Daily	
Air Intake Tubes and Clamps	Inspect for leaks and clamp tightness.	Daily	
Air Tanks	Drain water.	Daily	
Coolant	Inspect for signs of coolant leaks. Check coolant level using sight glass or electronic monitor.	Daily	
Engine	Inspect for signs of oil or coolant leaks.	Daily	
Engine Oil	Inspect for signs of oil leaks. Check oil level using dipstick, sight glass, or electronic monitor.	Daily	
Exhaust	Inspect for leaks and clamp tightness.	Daily	
Throttle Pedal	Check for smooth operation and return ability.	Daily	
Tires	Check inflation pressure. Inflate to correct pressure per the tire manufacturer's load/inflation recommendations.	Daily	
Transmission Fluid	Inspect for signs of oil leaks. Check level using dipstick or electronic monitor. Also note physical appearance of transmission fluid.	Daily	
Air Cleaner	Check air intake restriction indicator.	Daily	
Air Intake Tubes and Clamps	Inspect for leaks and clamp tightness.	Daily	
Air Tanks	Drain water.	Daily	
Comments or Additional Items			

7-1.3 Weekly Inspections

Weekly Preventative Maintenance, Checks, and Services			
System/Component	Action	Standard Interval	Alternate As Indicated
Aerial Boom Support	Inspect fasteners for tightness and integrity.	Weekly	
Air Dryer	Test purge pressure.	Weekly	
Air Inlet	Inspect engine air inlet for dirt, debris, or plugging.	Weekly	
Axle, Front	Inspect for signs of wear, damage, or looseness.	Weekly	
Belts	Inspect for damage and check tension.	Weekly	
Brake Linings	Inspect for sufficient lining thickness.	Weekly	
Brakes	Inspect all brake parts for integrity. (See <i>“Brakes – General”</i> on page 6-12.)	Weekly	
Cab Tilt System	Check fluid level. (See <i>“Cab Tilt System”</i> on page 6-1 for fluid type.)	Weekly	
Driveshafts	Inspect for signs of damage.	Weekly	
Electrical Connectors	Inspect for tightness, corrosion, and integrity.	Weekly	
Electrical Harnesses and Wires	Inspect for rubbing, fraying, or looseness.	Weekly	
Frame Fasteners	Inspect for looseness, wear, or corrosion.	Weekly	
Fuel System	Inspect for signs of damage, leaking, or chafing.	Weekly	
Fuel-Water Separator	Check water collection bowl and drain condensate.	Weekly	
Mirror Hardware	Inspect fasteners for tightness and integrity.	Weekly	
Seat Belt Assemblies	Inspect for signs of damage, wear, or corrosion. (See <i>“Seat Belts”</i> on page 6-5 for additional information.)	Weekly	
Springs	Inspect for signs of wear, cracking, or bending.	Weekly	
Steering Hydraulic System	Check oil level using dipstick, sight glass, or electronic monitor. Fill with TES-389 approved fluid.	Weekly	
Steering System	Inspect all steering parts for integrity. (See <i>“Steering”</i> on page 6-31 for additional information.)	Weekly	
Suspension Hangers and Shackles	Inspect for signs of wear, corrosion, or damage.	Weekly	
Tires	Inspect tread depth and check for damage.	Weekly	
Wiper Blades	Clean wiper blades.	Weekly	
Comments or Additional Items			

LUBRICATION AND MAINTENANCE INTERVALS

7-1.4 Monthly Inspections

Monthly Preventative Maintenance, Checks, and Services			
System/Component	Action	Standard Interval	Alternate As Indicated
Air Drier	Check for moisture in air drier and air system.	Monthly	25,000 miles / 40,000 km or 900 hours
Axle, Rear	Check oil level in carrier.	Monthly	10,000
Battery Posts	Clean and grease after cleaning.	Monthly	
Cab Tilt Pivot Pins	Lubricate with Lithium NLGI Grade EP2 grease.	Monthly	3,000
Cab Tilt Remote Control Receptacle	Lubricate with NYK corrosion preventative compound (Trucklite 97944 or equivalent).	Monthly	3,000
Driveshaft Slip Joints	Lubricate with Lithium NLGI grade EP2 grease.	Monthly	3,000
Driveshaft U-Joints	Lubricate with Lithium NLGI grade EP2 grease.	Monthly	3,000
Radiator and Charge Air Cooler Cores	Clean debris to ensure unimpeded air flow through cores.	Monthly	3,000
Spring Pins	Lubricate with Lithium NLGI grade EP2 grease.	Monthly	3,000
Steering Intermediate Links	Lubricate with Lithium NLGI grade EP2 grease.	Monthly	3,000
Wheel Bearings, Oil (Front Axle)	Check fluid level and add as required.	Monthly	3,000
Wheel Nuts	Check torque and tighten as required.	Monthly	3,000
Body Door Hinges	Inspect and Adjust. Spray with silicone lubricant.	Monthly	
Body Door Latches and Positive Door Holders	Lubricate with Lubriplate105 grease or equivalent.	Monthly	
Body Door Strikers	Inspect and adjust.	Monthly	
Comments or Additional Items			

7-1.5 Semi-Annual Inspections

Semi-Annual Preventative Maintenance, Checks, and Services			
System/Component	Action	Standard Interval	Alternate As Indicated
Air Conditioning	Inspect sight glass. See <i>“Air Conditioning Sight Glass”</i> on page 6-4 for additional information.	6 Months	
Automatic Slack Adjusters	Lubricate with clay-based NLGI Grade 1 or 2 grease. (See Meritor lube chart for additional information).	6 Months	See Axle Manual
Disc Brake Calipers	Lubricate with clay-based NLGI Grade 1 or 2 grease (See Meritor lube chart for additional information.)	6 Months	See Axle Manual
Cab Door Hinges	Inspect and Adjust. Spray with silicone lubricant.	6 Months	
Cab Door Latches	Lubricate with Lubriplate105 grease or equivalent.	6 Months	
Cab Door Strikers	Inspect and adjust.	6 Months	
Door Window Regulators	Lubricate with Lithium NLGI grade EP2 grease.	6 Months	
Fifth Wheel	Lubricate the fifth wheel bearing connecting the tractor to the tiller trailer. See <i>“Fifth Wheel Lubrication (Tiller Only)”</i> on page 6-9 for additional information.	6 Months	3,000
Seat Adjuster Slides	Lubricate with Lithium NLGI grade EP2 grease.	6 Months	
Steering Gear	Lubricate with Lithium NLGI grade EP2 grease.	6 Months	
Tire Alignment (Front Axle)	Check toe-in on front tires.	6 Months	
Transmission Fluid	Trucks in <i>severe duty</i> applications, or trucks equipped with <i>transmission retarders</i> , should have transmission fluid tested for water and glycol contamination. See <i>“Transmission Fluid Analysis”</i> on page 6-29 for additional information.	6 Months	12,000 miles 500 hours
Treadle Valve	Inspect, clean, and lubricate treadle valve pivot pin and piston cylinder using a Barium grease, spec BW-204-M.	6 Months	25K miles 900 hours
Comments or Additional Items			

LUBRICATION AND MAINTENANCE INTERVALS

7-1.6 Annual Inspections

Annual Preventative Maintenance, Checks, and Services			
System/Component	Action	Standard Interval	Alternate As Indicated
Air Cleaner	Replace air cleaner or filter element.	Annual	As required
Axle, Front Kingpin	Lubricate with Lithium NLGI grade EP2 grease.	Annual	100,000
Axle, Tie Rod Ball Joints	Lubricate with Lithium NLGI grade EP2 grease.	Annual	100,000
Cab Mounting Bolts	Check torque and tighten as required.	Annual	
Spring U-Bolts	Check torque and tighten as required.	Annual	24,000
Steering Drag Link Ball Joints	Lubricate with Lithium NLGI grade EP2 grease.	Annual	100,000
Steering Hydraulic System	Replace filter and hydraulic fluid in power steering reservoir(s) with TES-389 approved fluid.	Annual	
Comments or Additional Items			

7-1.7 3-5 Year Inspections

3-5 Year Preventative Maintenance, Checks, and Services			
System/Component	Action	Standard Interval	Alternate As Indicated
External Transmission Cooler	Replace external transmission cooler. See " External Transmission Coolers " on page 6-30 for additional information.	3-5 years	
Comments or Additional Items			

7-1.8 Vendor Component Inspections

Annual Preventative Maintenance, Checks, and Services			
System/Component	Action	Standard Interval	Alternate As Indicated
Air Dryer Desiccant	Replace desiccant.		See Air Dryer Manual
Air Dryer	Rebuild air drier including desiccant cartridge		See Air Dryer Manual
Axle, Rear	Replace lubricant (initial drain and fill).		See Axle Manual
Axle, Rear	Replace oil & oil filter (if applicable) in carrier.		See Axle Manual
Coolant	Replace coolant after flushing system.		See Engine Manual
Coolant Filter	Replace.		See Engine Manual
Engine Oil	Replace with engine manufacturer's recommended grade and viscosity.		See Engine Manual
Engine Oil Filter	Replace.		See Engine Manual
Engine Thermostats	Test and replace if defective.		See Engine Manual
Fuel Filter	Replace element.		See Engine Manual
Rear Suspension	Refer to the rear suspension manufacturer's maintenance manual for maintenance schedules, lubrication recommendations, and inspection procedures.		See Rear Suspension Manual
Transmission Filters	Replace with transmission manufacturer's approved filters.		See Transmission Manual
Transmission Fluid	Replace with transmission manufacturer's recommended fluids and viscosity.		See Transmission Manual
Wheel Bearings, Grease (Front Axle)	Lubricate with Lithium NLGI grade EP2 grease.		See Axle Manual
Wheel Bearings, Oil (Front Axle)	Replace lubricant.		See Axle Manual
Comments or Additional Items			

Additional Information

- See the Pierce Service Manual, group 0152-P-004, TAK-4™ Maintenance, Inspection, and Troubleshooting, for additional front TAK-4™ suspension service and lubrication requirements.
- See the Pierce Service Manual, group 0201-P-001 (TAK-4®) or 0201-P-002 (TAK-4® T3) Maintenance, Inspection, and Troubleshooting, for additional rear TAK-4 rear suspension service and lubrication requirements.
- See the Pierce Service Manual, group 0611-P-001, All Steer II® Service Manual, for additional All Steer II® service and lubrication requirements.



SPECIAL NOTE:

The information contained in this guide has been prepared for use by persons installing two-way radio equipment (transmitters and receivers) in Pierce apparatus. It has been prepared in accordance with current engineering principles and generally accepted practices, using the best information available at the time of publication. These guidelines are intended to supplement, but not be used in place of, detailed instructions for such installations which are the sole responsibility of the manufacturer of the land mobile radio. Since it is not possible to cover all possible installations of two-way radio equipment, Pierce Manufacturing cannot be held responsible for incidental or consequential damages arising from the use of the information contained herein. Certain land mobile radios, or the way in which they are installed, may affect vehicle operations such as the performance of the engine and driver information, entertainment, and electrical charging systems. Expenses incurred to protect the vehicle systems from any diverse effect of any such installation are not the responsibility of Pierce Manufacturing.

1. General Information

Pierce apparatus are designed and tested for safe operation with properly installed and properly used land mobile radio communications equipment with up to 150 watts of transmitter power.

Special design considerations are incorporated into all Pierce apparatus electronic systems to provide immunity to radio frequency signals. In addition, Pierce installed electrical systems and components are designed to control undesired electromagnetic radiation and radio frequency interference resulting from the use of such equipment. To maintain compatibility with vehicle electronic systems, mobile two-way radio and telephone equipment must be installed properly by trained personnel, observing these general guidelines:

- Power and ground connections should be made directly to the battery or radio power and ground distribution terminals located inside the chassis power distribution box.
- When possible, solder should be applied to power and ground wire terminations.
- Avoid cigar lighter or "power point" receptacles as power sources for radio communication equipment.
- The radio equipment circuit protection devices (fuses) should be installed as close as possible to the power and ground source.
- Antennas for two-way radios should be permanently mounted on the roof of the vehicle.
- The antenna cable should be high quality, fully shielded coaxial cable, and kept as short as practical.
- Avoid routing the antenna cable in parallel with vehicle wiring over long distances.
- Carefully match the antenna and cable to the radio to achieve a low Standing Wave Ratio (SWR) and to avoid RF currents on the antenna cable shield.

All installations should be checked for possible interference between the communications equipment and vehicle electronics. Mobile radio equipment with greater than 150 watts output may require special precautionary measures beyond those outlined in this document.

This pamphlet is provided as a supplement to the radio manufacturer's installation instructions for installing communications equipment in Pierce apparatus. Additional sources of information are listed in *"Additional Information"* on [page A-3](#).

Radio transmitters are regulated by the Federal Communications Commission (FCC) in the United States. Compliance with FCC regulations is the responsibility of the manufacturer and/or user of the transmitter equipment, not Pierce Manufacturing.

2. Installation Guidelines

2.1. Transceiver Location

- A transceiver location should be selected that provides a solid mounting point which does not interfere with the vehicle operator controls and provides adequate ventilation.
- Locate transceiver for remote radios away from other electronic devices and as near to the vehicle body side as possible.
- Before using screws to mount the transceiver equipment, be sure to check for vehicle wiring behind the instrument panel which could be pinched, cut, or otherwise damaged.

2.2. Radio Wiring and Routing

- Transceiver power connections should be made directly to the battery or radio power and ground distribution terminals and appropriately fused at that location.
- Any negative lead from a handset or control unit must return to battery negative. It is preferable that the positive lead for a handset or control unit be connected directly to the radio power distribution terminal.
- It is also recommended that the handset or control unit positive and negative leads be appropriately fused separately from the transceiver positive and negative leads.
- When possible, solder should be applied to power and ground wire terminations.
- Use caution when routing wires between the passenger and engine compartments to avoid chafing or pinching of wires. Use grommets over any exposed sharp edges and strain reliefs to keep wires in place. Seal all holes to prevent moisture intrusion.
- Route and secure all under-hood wiring away from mechanical hazards such as exhaust manifolds and moving parts (steering shaft, throttle linkage, fans, etc.).
- Maintain as great a distance as possible between mobile radio power leads and the vehicle's electronic modules and wiring. Avoid running power leads in parallel with vehicle wiring over long distances.

2.3. Antenna Location and Installation

- Every vehicle model and body style reacts to radio frequency energy differently. Antenna location is a major factor in these effects.
- Permanently installed antennas are preferable over magnetic, glass, or body lip mounts for anything other than for low power or temporary installations. Most of these alternate antennas can reflect significant power back at the feed point; this reflected power could then radiate from the feed line inside the passenger compartment and be picked up by the vehicle wiring. However, a magnetic mount antenna is a good tool for checking the proposed fixed antenna location for unwanted effects on the vehicle, since antenna location is a major factor in these effects.

IMPORTANT: The antenna should be tuned properly and reflected power be kept to less than 10% (VSWR less than 2:1). Never adjust antenna length while the radio is being keyed.

NOTE: Your installation should be checked periodically for proper SWR and any signs of damage or deterioration to maintain proper operation with your vehicle.

- The United States Department of Labor, through provisions of the Occupational Safety and Health Act of 1970 (OSHA), has established an electromagnetic safety standard which applies to the use of mobile radios. Proper installation and use will result in exposure below the OSHA limit. Antennas must be located at least two feet (0.6 meters) from vehicle operators and passengers, unless shielded by a metallic surface.

-
- Pierce Manufacturing recommends that mobile antennas be located as near the center of the cab roof as possible.
 - Antennas should not be located within six inches (15.24 cm) of roof mounted equipment, e.g., emergency lights, air conditioner evaporators.

2.4. Antenna Cable Routing

- Always use a high quality, one-piece coaxial cable (at least 95% shield coverage). Connector quality and termination techniques are just as important. The ARRL handbook provides excellent guidelines for terminating coaxial cables.
- The cables should be kept as short as possible to minimize RF loss for all frequency ranges, except 470–512 Mhz. When the antenna operates in the 470–512 Mhz range, do not cut the antenna cable unless absolutely necessary! If the cable must be shortened, refer to the table on the antenna kit tag for proper output setting.
- The antenna cable should be treated in the same way as the control and power cables. Avoid sharp edges and pinches, and keep the cable as short as possible.
- Avoid routing the antenna cable in parallel with vehicle wiring over long distances. If it is necessary to cross over wiring, cross at right angles. (In some cases, additional shielding between the antenna cable and the vehicle wiring may be helpful.)

3. Additional Information

3.1. Troubleshooting

Should vehicle-radio interaction develop following installation, the source of the problem should be identified prior to further operation of the vehicle. Most interaction problems can be eliminated by following these installation guidelines:

Possible causes of vehicle-radio interaction include:

- Antenna location (move antenna to another position);
- Antenna feed line routing (locate as far as possible from vehicle electronics and wiring);
- Inadequate shielding or loose/corroded connectors associated with the antenna feed line;
- Mismatched antenna or high SWR;
- Power and ground feeds not connected directly to the vehicle battery or radio power distribution points;
- Power feed routing (locate as far as possible from vehicle electronics and wiring).

If any vehicle-radio interaction problems exist after following these guidelines, contact your radio manufacturer or the Pierce Customer Service for additional assistance.

3.2. Additional Sources of Information

Radio Frequency Interference: How to Find It and Fix It
ISBN: 0-87259-375-4
The American Radio Relay League, Inc.
Newington, Connecticut 06111-1494
Phone: (203) 666-1541
Fax: (203) 665-7531

Giving Two-Way Radio Its Voice (booklet)
Champion Spark Plug Company
Automotive Technical Service Department
Box 910
Toledo, Ohio 43661

3.3. Internet News Groups

rec.radio.amateur.equipment

rec.radio.amateur.misc

APPENDIX B

EXTERIOR CARE OF YOUR VEHICLE



B-1. Exterior Care of Your Vehicle



B-1.1 Finished Surfaces of the Vehicle

Your vehicle may have a variety of surfaces to care for, many of which may have different recommendations for proper care. These may include:

- Painted surfaces
- Graphics, lettering, and striping
- ABS plastic, acrylics, or polycarbonate (LEXAN)
- Anodized aluminum
- Chrome
- Underbody

Caring for the paint and other surfaces is the first line of defense in keeping the vehicle in service and free of corrosion or other issues.

B-1.1a Graphics, Lettering, and Striping

Pierce Custom Cabs may be adorned with graphics using any or all of the following methods:

Graphics Type	Description
Goldstar	A process which encapsulates 22-karat gold leaf paint or vinyl between two laminations for maximum protection. Goldstar is applied to the vehicle using an aggressive bonding agent.
Gold leaf	A 22-karat gold leaf applied directly over a painted surface and protected with a clear polyurethane topcoat.
Reflective Vinyl	A vinyl product available in either regular or reflective sheeting using an aggressive bonding agent.
Paint	A lettering enamel brushed directly on top of a painted surface.

B-2. Washing the Vehicle

B-2.1 Proper Washing Equipment and Methods

CAUTION

Avoid washing with high water pressure, hot wash solutions, abrasive detergents, or rough cleaning motions.

NOTE: Compartment and entry door jams, door sills, and the bottoms of compartment and entry doors should be washed each time the vehicle is washed. These areas are subject to the same elements and dirt build up as the body and should be washed and dried to prevent build up of salt, chemicals, and other contaminants which can damage the surface and cause corrosion.

- Never use abrasive cleaners, chemicals, or rough applicators such as steel wool or scuff pads on the vehicle, as these will damage the finished surface.

Washing removes small particulates that can scratch the painted surfaces. It also removes contaminants that can etch the paint and accelerate corrosion.

- Wash the vehicle only when dirty. Excessive daily washing should be avoided, unless the vehicle is dirty. To remove light dust without getting the truck wet, wipe off with a clean damp cloth or chamois. A “dry wash” commercial product can also be used to remove light soils. (Follow product manufacturer’s instructions.)
- Wash all soils off as soon as possible, especially road salts, fuel, industrial fallout, etc., from inside and outside surfaces.

B-2.1a Soaps or Detergents

Use a mild, non-abrasive detergent soap or a “wash and wax” type soap specifically formulated for vehicle washing. This type soap has been formulated to have minimal effect on waxed surfaces. Harsher de-greasing soaps (i.e. dish soap) can be abrasive to the surface, including graphics, and/or strip the protective wax. Mix with cool or luke-warm water at the recommended dilution.

B-2.1b Water

NOTE: Culligan is a good source for water testing and purifying equipment. Detailed information is available at: <http://www.culligan.com>

Clean and “pure” water is also essential to proper finish care. Your water supply may contain minerals and or chemicals affecting its purity. Water is too hard if above 120ppm; pH should be between 6 and 8. Water that has a pH below 7 is acidic. Acidic water will etch the paint and accelerate corrosion in crevices, under hardware and around fasteners. The water’s purity can be tested with a kit or by a local water testing company.

B-2.1c Washing Application

A clean sponge, soft mitt, or soft bristle brush is recommended using a gentle cleaning motion. Rinse the applicator often to avoid dirt build-up which can scratch the finished surface.

Low pressure water is recommended for spraying and rinsing the vehicle. Avoid using a pressure washer on the vehicle’s surface (see “*Pressure Washing*” on [page B-3](#)).

B-2.1d Pressure Washing

CAUTION

As a rule, pressure washing should only be done on the underside of the vehicle. Pressure washing should **NOT** be done on any surface that has Goldstar, gold leaf, vinyl striping, labels, or overlays. When washing using high water pressure, all grease fittings outside and underneath the vehicle chassis must be lubricated after washing to dissipate water and contaminated grease.

B-2.2 General Washing Instructions

NOTE: Never wash in direct sunlight, as the surface temperature may be too hot.

- After washing and rinsing, or after vehicle use in the rain, always blow-dry or wipe dry with a soft cotton towel, especially areas that will trap water. Open up all doors and dry off the interior surfaces and door latches. **NEVER LET THE VEHICLE SIT WET.** Ceiling fans and/or floor ventilation is recommended. When possible, park the vehicle outdoors and open up all vehicle doors to let all areas dry out.
 - Clean Goldstar, gold leaf, vinyl, painted surfaces using mild, non-abrasive liquid “wash-n-wax” type solutions. Follow manufacturer’s mixing instructions. Wash with warm water (not hot), using gentle water pressure and a clean, soft cloth.
 - Clean anodized aluminum trim using only mild detergents and lukewarm water. Rinse immediately. Damage to these parts can occur if cleaning solutions having excessive acidity or alkalinity are used.
1. Pre-wet the entire surface to be washed.
 2. Wash the vehicle in sections which can be rinsed clean before the soap dries. Do not allow soap to dry on the surface.
 3. Apply the soapy wash solution using a sponge, mitt, or soft brush, from the top of the vehicle down, with a gentle cleaning motion. Rinse the applicator often. Be sure to wash all spaces, cracks and crevices, including compartments, door sills/jams, behind rub rails, etc.
 4. Dry all surfaces with a clean, soft, non-abrasive cloth or chamois. Allow to completely dry in an environment where relative humidity is below 60%. Never let the vehicle sit wet. Open all doors and compartments when possible to allow drying.

B-2.3 Tar, Rust or Other Containment Removal

- Tar removal can be done with Naphtha thinner applied with soft tissue or with a commercially available tar remover (follow product manufacturer’s instructions).
- Rust and tarnish removal can be cleaned away with a special mixture of 1 part laundry detergent, 1 part kerosene, and 1 part lukewarm water.

B-2.4 Chrome Cleaning

- Wash chrome parts using mild soap and water, with a clean non-abrasive towel.
- After washing, rinse with water and hand dry chrome parts.
- If needed, apply a soft non-abrasive chrome polish.
- Never use any products that scratch or chemicals that are abrasive, as this will dull the chrome finish.
- Do not use any acid or hydrozide based chemicals.

B-2.5 ABS Plastic and Clear LEXAN Component Care

1. Wash with a mild solution of soap or detergent and lukewarm water.
2. Using a soft cloth or sponge, gently wash the sheet to loosen dirt and grime and rinse well with water.
3. To prevent spotting, thoroughly dry with chamois or cellulose sponge.
4. Avoid the use of abrasive cleaners and/or cleaning implements, such as brushes that may mar or gouge the coating.

B-2.6 Undercarriage Cleaning and Protection

CAUTION

As a rule, pressure washing should only be done on the underside of the vehicle. Pressure washing should NOT be done on any surface that has Goldstar, gold leaf, vinyl striping, labels, or overlays. When washing using high water pressure, all grease fittings outside and underneath the vehicle chassis must be lubricated after washing to dissipate water and contaminated grease.

Road de-icing agents such as liquid agents or traditional road salts increase the risk of chassis corrosion. Liquid de-icing agents tend to stick to surfaces and wick into narrow gaps more readily than road salt, and cause corrosion when humidity is present. The following are suggestions to inhibit the risk of corrosion:

- Thoroughly pressure wash the undercarriage of the apparatus frequently with plain water to remove salt and chemicals.

NOTE: DO NOT mix rust-proofing products together. They may not be compatible with each other.

- Apply a rust proofing compound to the undercarriage of the apparatus:
 - Pierce recommends an annual application of Carwell®. Carwell is an oil based product designed to prevent or stop corrosion. It is available from Pierce® dealers trained in its application, or it can be applied by yourself. It is an inexpensive way to reduce corrosion on frame rails, supports, etc.
 - Other rust proofing methods such as Ziebart may also be used.
- Inspect the undercarriage regularly to identify any corrosion at an early stage. Once identified, the area should be cleaned thoroughly, coated with a rust inhibiting system such as "POR-15®" and then painted. (Information on POR-15® can be found on their website at "www.por15.com")
- Remove water from the floor where the apparatus sits. Use a fan to keep the area dry.
- Hose out the radiator with plain water.
- Keep mud flaps in good repair to minimize salt/chemical spray.
- Avoid splicing into wiring. If repairs are needed use shrink terminals.
- Clean out electrical connectors regularly. Inspect for signs of corrosion to terminals. Verify locking tabs and seals are in place. Replace as necessary. Do not use dielectric grease on any Packard or Deutsch weatherproof connectors.

B-3. Protecting the Finished Surface

B-3.1 Waxing the Vehicle

CAUTION

Avoid hand waxing Goldstar and vinyl surfaces. Wax solutions frequently consist of small abrasive materials. These materials will scratch and dull the vinyl surface. Hand wax around these products to avoid abrasion.

Wax makes the painted surfaces easier to clean and dry. Waxes produce a durable, high gloss finish that fills and minimizes minor surface scratches. Wax should be reapplied when water no longer beads up on the surface. Recommended products are: "Wax, 3M Perfect-It Show Car Wax – P/N 39021" and "Polish, 3M One Step Cleaner Wax – P/N 39006". Follow manufacturer's recommendations for application and removal.

- Paint finish may be hand waxed 90 days after delivery with a non-abrasive wax, applied lightly, and softly buffed. **Do not wax any of the Goldstar, gold leaf, or other vinyl. Wax around it!**
- Never wax in direct sunlight, as the surface temperature may be too hot.
- Properly wash vehicle first.
- Bright metals may be polished using a non-abrasive polish.
- Polish can be used in the event that surface contaminants remain on the surface after washing and waxing or if there are minor scratches in the painted surface that have reduced the gloss.

B-3.2 Preventing Dissimilar Metal Corrosion

Rapid corrosion can occur when two different types of metals are in contact with each other. This occurs when the two metals are subject to moisture. Electrons will begin to pass from the least corrosion-resistant metal to the other, similar to the way a dry-cell battery works. This leads to rapid corrosion known as galvanic corrosion. Even a small scratch on a painted surface can be enough to create galvanic corrosion.

The more dissimilar the metals (i.e. aluminum and stainless steel), the more rapid the corrosion rate. However, similar metals can still lead to galvanic corrosion.

When mounting equipment or accessories such as after market equipment to the vehicle, follow these recommendations:

- Select metals (both equipment and fasteners) that are as similar as possible to minimize galvanic corrosion.
- Avoid all contact between the metals using a corrosion-inhibiting material(s) such as tape, paste, washers, or compounds conforming with MIL-C-0083993A. Completely protect screws and fasteners including threads and head, and completely protect the two mounting surfaces from coming in contact with each other.
- Read and follow the manufacturer's instructions for any products used to prevent galvanic corrosion.
- Visually inspect the areas on a frequent basis to catch and correct any signs of corrosion before they get worse.

B-4. Finish Touch-Up and Repair

B-4.1 Goldstar Striping Repair Instructions

Any Goldstar product that is replaced must have all cut edges sealed. Seal all cut edges with a two part polyurethane clear coat. Paint all end borders with matching color lettering enamel before applying clear coat. Failure to apply clear coat to the edges of cut Goldstar products will cause delaminating.

B-4.2 Gold Leaf Re-coating Instructions

Re-coat Gold Leaf painted surfaces every 12 to 18 months (depending on vehicle duty cycle) using a two part polyurethane clear coat.

B-4.3 Paint Touch-Up

NOTE: Raabe is a good source for touch up paint. Detailed information is available at: <http://www.raabecorp.com>.

Touch up paint if the surface has been nicked or scratched and the undercoat (primer) or bare metal has been exposed. If bare metal is left untreated, moisture will penetrate the paint and corrosion will start. Once corrosion starts, it will continue to grow.

Repair any nicks or deep scratches in the paint as soon as discovered with commercially available touch-up primers and paints.

1. Clean the area with Wax & Grease Remover or Naphtha.
2. If bare metal is exposed, any corrosion must be removed. This should be done with a fine abrasive. Reclean surface if necessary.
3. If bare metal is exposed, primer should be applied.
4. Apply the color coat touch-up paint to a sample piece to ensure good a color match. Apply a thin coat of color. If a second coat is required, allow the first coat to dry.

B-4.4 Professional Surface Restoration

If minor surface scratches or nicks cannot be repaired using methods previously explained, a trained professional should make the necessary repairs.



Numerics

3-5 Year Inspections	7-6
4x4 (All Wheel Drive) and Two-Speed Axle Combination	5-45
4x4 Transfer Case (All Wheel Drive)	5-45

A

ABS Plastic and Clear LEXAN Component Care	B-4
Active Regeneration Cummins	5-24
Detroit Diesel	5-29
Aerial Device Boom Support	6-7, 7-1
After Treatment Device Indicator Lights Cummins	5-23
Detroit Diesel	5-28
After Treatment Systems	5-22
Air and Rubber Suspensions	3-12
Air Conditioning	6-3
Air Conditioning Sight Glass	6-4
Air Dryer	5-53, 6-13
Air Filter Replacement	6-22
Air Intake and Charge Air Cooler Hose Clamps	6-22
Air Intake System	6-22
Air Pressure Gauge, Indicator Light, and Audible Alarm	5-50
Air Pressure Operated Equipment	3-10
Air Reservoir Moisture Draining	5-53
Air Restriction Indicator	5-39
ALL STEER® All-Wheel Steering	6-32
Alternator	5-13, 6-19
Aluminum Rear Disc Wheels with Flange Nuts (Hub Piloted)	6-52
Ammeter	5-13
Annual Inspections	7-6
Antifreeze Type	6-25
Antilock Braking System (ABS)	5-50
Automatic Active Regeneration Cummins Engines	5-24
Detroit Diesel	5-29
Automatic Lubrication System	6-7
Additional Information	6-11
Condition of Lube Points	6-7

Inspection	6-7
Reservoir	6-7
Automatic Transmission	5-44
Auxiliary Braking System	5-54
Auxiliary Front Wheel Lock	5-53
Auxiliary Power Units (APUs)	6-20
Axle Weights and Axle Capacity	3-1
Axles	5-46, 6-11
No Spin Differential	5-46

B

Backing the Vehicle	2-7
Balancing	6-47
Batteries	6-19
Battery	5-14
Battery Charging Precautions	5-14
Battery Switch	5-15
Bearings	6-48
Before Placing Vehicle in Service	3-1
Beginning the Inspection	5-1
Belt Inspection and Installation	6-23
Brake Balance	3-2
Brake Burnishing	3-5
General Information	3-5
Procedure	3-5
Brake Burnishing and Grade Holding	5-53
Brake Testing	5-8
Brakes	5-50, 6-12
Brakes – General	6-12
Brakes – TAK-4™ Suspension	6-13
Bumper Extension Carriage Bolts	6-8

C

Cab Exterior Equipment	3-8
Cab Interior Equipment	3-9
Cab Lift System	5-12
Cab Occupant Capacity	5-10
Cab Tilt Operation	5-11
Cab Tilt System	6-1
Caging Brakes	5-52
Canceling Stationary Regeneration Cummins	5-26

INDEX

Detroit Diesel	5-32
Carwell Removal	3-7
Cast Spoke Wheels	6-51
Cast Spoke Wheels, Installation	6-51
Chain Clearance, Front Tires	5-58
Chrome Cleaning	B-4
Circuit Breakers and Fuses	5-15
Cleaning	6-19
Cold Weather Operation	
Cab Tilt	6-1
Engine	5-42
Pump	5-42
Command Zone	4-23
Command Zone™ Diagnostics	6-18
Command Zone™ System	6-16
Compartment Doors	5-10
Component LED Heartbeat (Red)	6-18
Compression Brake	5-54
Control Systems	5-55
Coolant	6-25
Coolant Fill Procedure	6-26
Cooling System	5-37, 6-23
Custom Products	2-7
Customer Assistance Information	1-4
Customer-Installed Equipment	3-7

D

Daily Inspections	7-2
Daily Pre-Trip Inspection	5-1
Dana Drive Axle Wheel Differential Lock	5-47
Data Link Troubleshooting	6-18
Diesel Exhaust Fluid (DEF)	5-40
Diesel Fuel Requirements	5-40
Differential Lock,	
Inter Axle (IAD) (Tandem Axles)	5-47
Dissimilar Metal Corrosion	3-8, B-5
Dissimilar Metals	3-8
Do Not Occupy With Vehicle in Motion	4-2
Door Strikers	6-1
Doors and Windows	6-1
Downhill Operation or Heavy Braking	5-50
Drilling Holes	3-8
Driveshafts	6-29

E

Electrical	5-13
Before Servicing	6-21
Electrical, AC	6-19
Introduction	6-19
Electrical, DC	6-19
Electrocution Hazard from Overhead	
Power Lines	2-8
Electromagnetic Retarder	5-54
Electronic Stability Control (ESC)	5-57
Emergency Parking Brake Release	5-52
Emergency Shutdown	5-36
Engine	6-22
Running the Engine	5-35
Starting the Engine	5-34
Engine Diagnostic Software	
Cummins	6-23
Detroit	6-23
Engine Exhaust After Treatment Systems	5-22
Engine Mount Isolators	6-23
Engine Oil Requirements	5-40
Engine Service Schedule	6-23
Engines, General Notes	6-28
Engine-Specific Operation Instructions	5-35
Equipment and Cargo Loading	3-10
Exhaust Brake	5-54
Exhaust Diffusers	6-28
Exhaust System	6-27
Exterior Care	B-1
ABS Plastic	B-4
Chrome Cleaning	B-4
Finish Touch-Up and Repair	B-6
Graphics, Lettering, and Striping	B-1
Preventing Dissimilar Metal Corrosion	B-5
Tar, Rust or Other Containment Removal	B-3
Undercarriage Cleaning and Protection	B-4
Washing the Vehicle	B-2
Waxing the Vehicle	B-5
Exterior Inspection	5-5
Exterior Inspection, Rear Lights	
and Reflectors	5-7
External Transmission Coolers	6-30

F

Fan and Accessory Belts	6-22
Fan Clutch	5-38
Fasteners	6-7

Fault Light Information	6-6	Hose and Hose Reels	4-14
Fifth Wheel Lubrication	6-9	Hose Clamps	6-24
Finish Touch-Up and Repair	B-6	Hoses	6-24
Fire Scene Operation	5-17	Hourmeter	5-15
Fire Service Ratings	6-43	Hub Piloted Wheel Installation	6-49
Fluid Level (Non-Maintenance-Free Batteries)	6-19	HVAC - Arrow XT™	4-13
Fluid Requirements	5-40	Hydraulic Retarder	5-55
Flying Embers	5-17		
Foot Pedals, Adjustable	4-12	I	
Fording Water with Command Zone™ Vehicles	5-20	Ignition and Starter Switches	5-17
Frame Fasteners	6-8	Inflatable Head Curtain (IHC)	4-8
Front Axle – Non-Driving	6-11	Initial Inspection Upon Deliver	7-1
Front Axle – TAK-4™ Suspension	6-11	Input/Output Sheets (I/O Sheets)	6-18
Front Axle Alignment	6-11	Inspection, Approaching the Vehicle	5-1
Front Axle Drive, To Disengage	5-45	Inspection, Brake Drums or Shoes	5-2
Front Axle Drive, To Engage	5-45	Inspection, Equipment Loading	5-3
Front Spring/Suspension Adjustment	3-11	Inspection, Exhaust System	5-3
Front Tires	6-47	Inspection, Pre-Trip	5-1
Frontal Impact Protection	4-10	Inspection, Records Review	5-1
Fuel Delivery System	6-27	Inspection, Steering System	5-2
Fuel Filters	6-27	Inspection, Suspension System	5-3
Fuel System	6-27	Inspection, Tires	5-2
Fuses and Circuit Breakers	5-15	Inspection, Wheels and Rims	5-2
		Inspections, Scheduled	7-1
G		Instrument Panel	4-14
General Fording Instructions	5-19	Arrow XT®	4-15
General Inspection	6-31	Arrow XT™ Right Hand Steer	4-19
General Inspection and Service	6-24	Instrument Panel Controls & Indicators	4-14
General Warnings and Cautions	2-2	Integrated Belt Pretensioner (IBP)	4-8
Goldstar Striping Repair Instructions	B-6	Integrated Gas Pretensioner (IGP)	4-8
Grade Holding and Brake Burnishing	5-53	Inter Axle Differential (IAD) Lock (Tandem Axles)	5-47
Graphics, Lettering, and Striping	B-1	Interior Fasteners	6-7
Grease Fitting Location (Fifth Wheel Bearing) ..	6-9	Interior Inspection	5-4
		Inverters	6-20
H			
Hand Throttle	5-42	K	
Hazard Flashers	5-16	Keyless Entry	4-2
Heater Shut-Off	6-2		
Heating, Ventilation, Air Conditioning (HVAC)	6-2	L	
High Heat Sources	5-17	Latches and Window Regulators	6-1
High Pressure Hydraulic Fluid	2-9	Legal Requirements	5-1
Hinges	6-2	Lift and Tow	6-29

INDEX

Lift and Tow (using Frame Forks) - Arrow XT™/ Velocity™/Impel™	6-38
Lockout/Tagout	2-11
Low Fuel Warning Light	5-15
Lubrication Procedure (Fifth Wheel Bearing) ...	6-9

M

Maintenance	6-1
Cab Tilting Precautions During Maintenance	6-6
Maintenance, DPF, Cummins Engines .	5-27, 5-32
Manual Parking Brake Release	5-52
Manual Pump Operation	5-12
Matching Dual Tires	6-46
Meritor Driver Controlled Differential Lock (DCDL)	5-47
Mirrors	5-18
Mobile Radio Installation Guide	A-1
Modification	3-7
Moisture and Ember Separators	6-22
Monthly Inspections	7-4
Multiplex System Principals of Operation	6-17

N

Neutral to Drive Shift Growl – Allison MD Transmission	5-44
Non-Command Zone™ Components	6-18

O

Odometer and Speedometer	5-15
Operation	5-1
Operation in High Ambient Temperature Conditions	5-56
Operation of Engine in Fuel Rich Atmosphere	5-39
Oshkosh® TAK-4® Rear Axles	5-48
Other Fasteners	6-8
Overheat Warnings	5-55
Overview	6-16

P

Paint Touch-Up	B-6
Parked (Stationary) Regeneration	

Cummins	5-25
Detroit Diesel	5-30
Parking Brakes	5-51
Passive Regeneration	
Cummins	5-24
Detroit Diesel	5-29
Periodic Inspection	6-22
Power Take-Off Control	5-45
Precautions When Tilting the Cab During Maintenance Actions	6-6
Preparation for Towing	6-33
Pre-Trip Inspection	5-1
Professional, Training, and Standards Organizations	1-5
Pump	5-18
Pyrometer	5-15

R

Radio Equipment	3-8
Radio Installation	5-17
Rear Axle	6-11
Rear Axle – TAK-4™ Suspension	6-12
Rear Axle Alignment	6-12
Rear Spring/Suspension Adjustment	3-12
Rear Suspension	6-13
Rear Tires	6-47
Reasons for Daily Inspection	5-1
Refrigerant Recovery and Recycling	6-4
Regeneration	
Cummins	5-23
Detroit	5-28
Ford	5-23
Regeneration Inhibit	
Cummins	5-27
Detroit Diesel	5-32
Regeneration Inhibit While Pumping	
Cummins	5-27
Detroit Diesel	5-32
Responsibility	1-4
Retarder Brake Capacity	5-55
Rim and Wheel Inspection	6-52
Roll Stability Control (RSC)	5-56

S

Safe Vehicle Operation	5-56
Safety	5-1

Safety Defect Reporting	2-11	T	
Safety Restraints and Devices	4-4, 6-5	Tachometer	5-16
Safety Warning Labels	2-2	TAK-4® Rear Axles	5-48
SCBA Brackets Mounted in Seat Backs	4-11	TAK-4™ Steering	6-31
Scheduled Inspections		TAK-4™ Suspension	6-15
3-5 Year Inspections	7-6	TAK-4™ Suspension Towing	6-35
Annual Inspections	7-6	Tanker	2-9
Daily Inspections	7-2	Characteristics	2-9
Initial Inspection Upon Delivery	7-1	Description of Hazard	2-9
Monthly Inspections	7-4	Hazard Prevention	2-10
Semi-Annual Inspections	7-5	Tar, Rust or Other Containment Removal	B-3
Vendor Component Inspections	7-7	Terminals	6-19
Weekly Inspections	7-3	Thermostats	6-24
SCR Operation		Tire Chains	5-58
Cummins Engines	5-33	Automatic Tire Chains	5-59
Seat Adjustment	4-12	Chain Clearance	5-58
Seat Belt Monitoring System	4-5	Rear Tires	5-58
Seat Belts	4-4, 6-5	Tire Inflation	6-44
Semi-Annual Inspections	7-5	Tire Lift Method (Preferred)	6-37
Shore Power	6-20	Tire Pressure	3-2
Side Roll Protection System	4-5, 6-6	Tire Pressure Management Sensors	6-47
Components	4-6	Tire Pressure Management System	5-60
General Warnings and Cautions	4-6	Tire Replacement Information	6-48
Returning to Service	4-10	Tire Rotation	6-47
What to Do After a Deployment	4-10	Tire Warranty (Emissions Related)	6-47
What to Expect During the Deployment	4-9	Tire Wear Inspection	6-46
Speedometer and Odometer	5-15	Tires	6-43
Spring Pins	6-14	Fire Service Rating Rules	6-43
Spring Suspension (Front and Rear)	6-13	To The Owner	1-1
Spring Suspensions (Spring U-Bolts)	3-12	Tow Hooks and Tow Eyes	6-34
Springs	6-13	Towing Instructions	6-33
Stability Control	5-56	Front Towing	6-33
Starter and Ignition Switches	5-17	Rear Towing	6-34
Starting Engine Using Power From		Towing, Lift and Tow	6-29
Another Vehicle	5-38	Traction Control	5-51
Steering	5-58, 6-31	Transfer Case (All Wheel Drive)	6-30
Steering Column Adjustment	5-58	Transmission	5-44, 6-29
Steering Reservoir	6-31	Transmission Fluid	6-29
Steering System Fastener Torque	6-32	Transmission Fluid Analysis	6-29
Steering Wheel Controls	4-21	Transmission Operating Temperature	5-44
Stopping the Engine	5-36	Transmission, Automatic	5-44
Stud Piloted Wheel Installation	6-49	Troubleshooting Tips	6-17
Supplemental Restraint Airbag (SRA)	4-8	Turn Signal Switch	5-16
Surface Restoration	B-6	Two Speed Rear Axle	5-49
Suspension	3-12		
Suspension Seat Safety System (S4S)	4-7		
Suspension Shackles	6-14		

INDEX

U

Undercarriage Protection **B-4**

V

Vehicle Access **4-1**
 Automatic Steps **4-1**
 High Locations **4-1**
 Service Areas **4-1**
Vehicle Data Recorder (VDR) **4-22**
Vehicle Handling Characteristics **2-7**
Vehicle Identification **1-3**
Vendor Component Inspections **7-7**
Voltmeter **5-15**

W

Warning and Caution Statements **2-1**
Warning Lights **5-16**
Warnings and Cautions **2-1**
Warnings, Overheat **5-55**
Washing the Vehicle **B-2**
Water Fording Capability **5-19**
Water Pump **6-24**
Waxing Instructions **B-5**
Weatherstrip **6-2**
Weekly Inspections **7-3**
Welding **3-8**
Welding Instructions **6-40**
 After Welding **6-42**
 Battery System Protection **6-42**
 Before Welding **6-40**
Welding on Frames **6-40**
Wheel Installation – General **6-48**
Wheel Torque **6-52**
Wheels **6-48**
Who Should Use, Service, and Maintain
 This Vehicle **1-1**
Winch Operation **5-21**
Windshield Wiper System **4-21**
Winter Front Usage **5-43**
Wiper Blades **6-2**
Wire Harnesses and Electrical Connectors ... **6-19**