

2019 VHF RADIO COMMUNICATIONS REVIEW



UPDATED 11/21 - REMOVED SLIDES 20-25

OBJECTIVES

BK KNG Mobile Radio

Kenwood TK-790 Mobile Radio

BK GPH-CMD Portable Radio

Repeater Map

Fleet Map

Radio Scenarios – Programming a Command Group

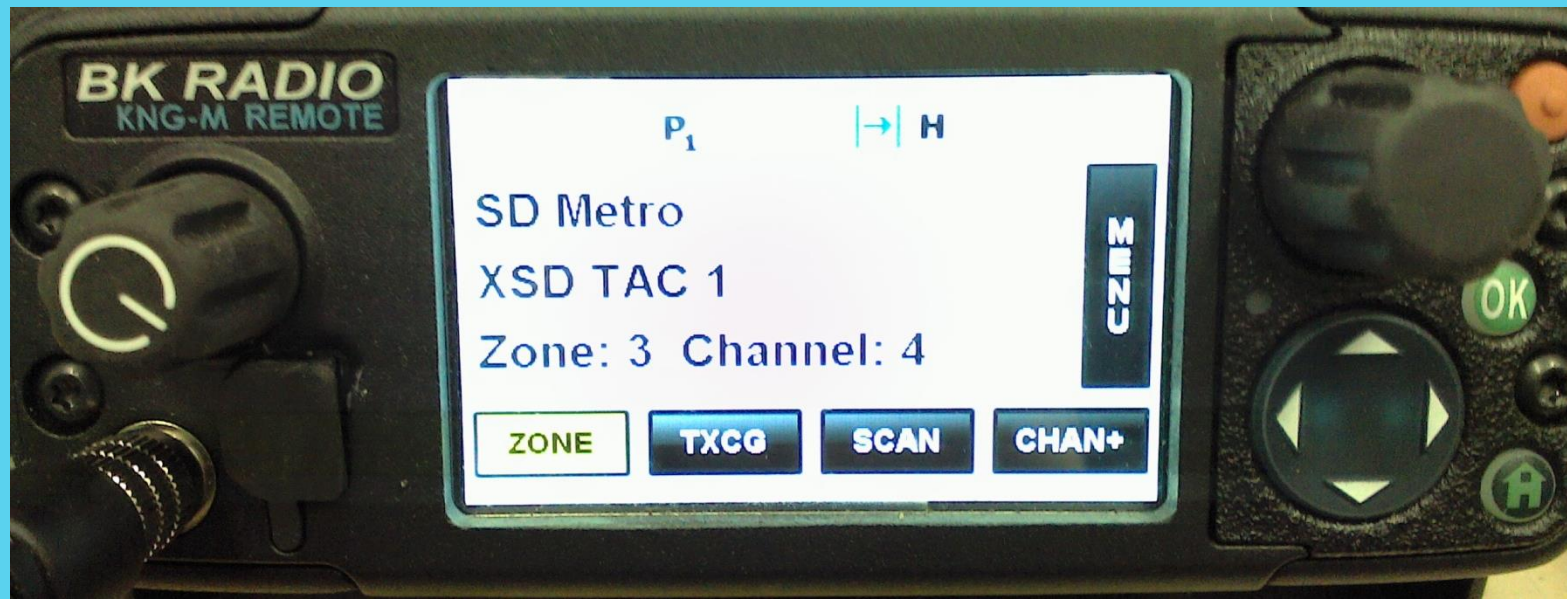

VS.



- ▶ FEATURES A COLOR LCD TOUCH SCREEN DISPLAY WITH DROP DOWN MENUS
 - ▶ CAPABLE OF 2048 CHANNELS AS OPPOSED TO THE KENWOOD 254
 - ▶ CAPABLE OF CLONING WITH OTHER BENDIX KING PORTABLE RADIOS
 - ▶ ABLE TO CREATE MULTIPLE COMMAND GROUPS.
 - ▶ CAPABLE OF P25 DIGITAL TRUNKED SYSTEMS
- 
- A decorative graphic consisting of several parallel white lines of varying lengths, slanted diagonally from the bottom right towards the top right, set against a blue gradient background.

CHANGING GROUPS

FROM HOME SCREEN PRESS
ZONE

TO SELECT ZONE USE ARROW
KEYPAD OR PREV/NEXT
BUTTONS

ONCE YOU FIND DESIRED
ZONE PRESS ENTER OR OK
BUTTONS



SELECTING A TONE (TXCG)

AFTER FINDING DESIRED CHANNEL

PRESS THE TXCG BUTTON

USE ARROWS OR
PREV/NEXT BUTTONS TO
FINE TONE

PRESS ENTER OR OK
BUTTON TO SELECT

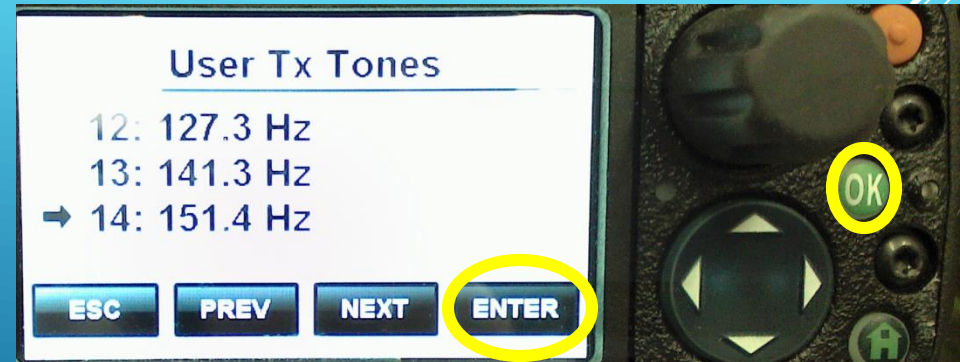
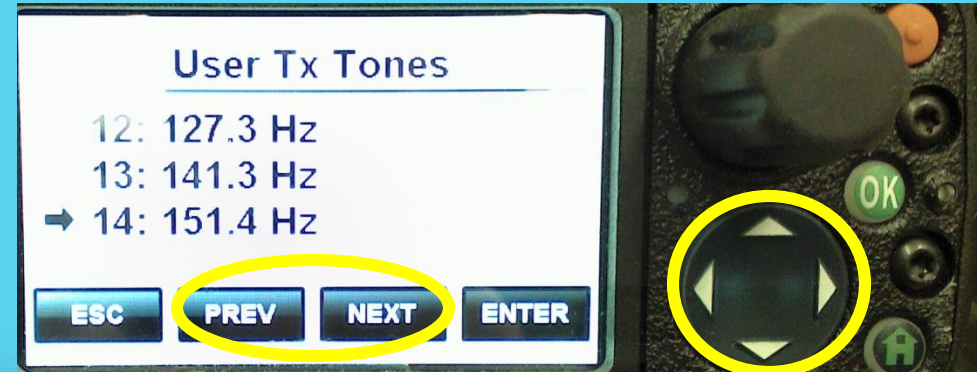

SELECTING A TONE CON'T

- ▶ SOME CHANNELS LIKE XSD CMD4 USE ONLY ONE TONE AND WILL BE FIXED TO THAT CHANNEL

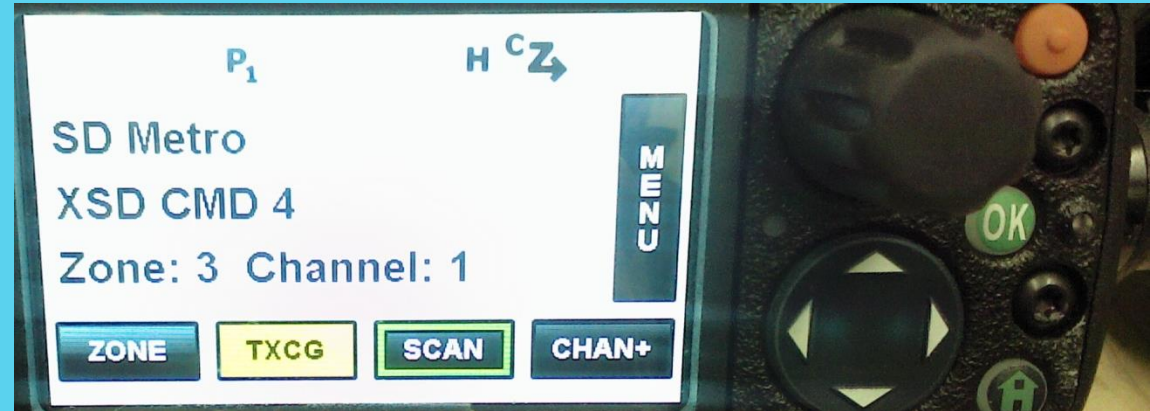

- ▶ WHEN TRYING TO CHANGE A TONE YOU'LL GET THIS ERROR MESSAGE

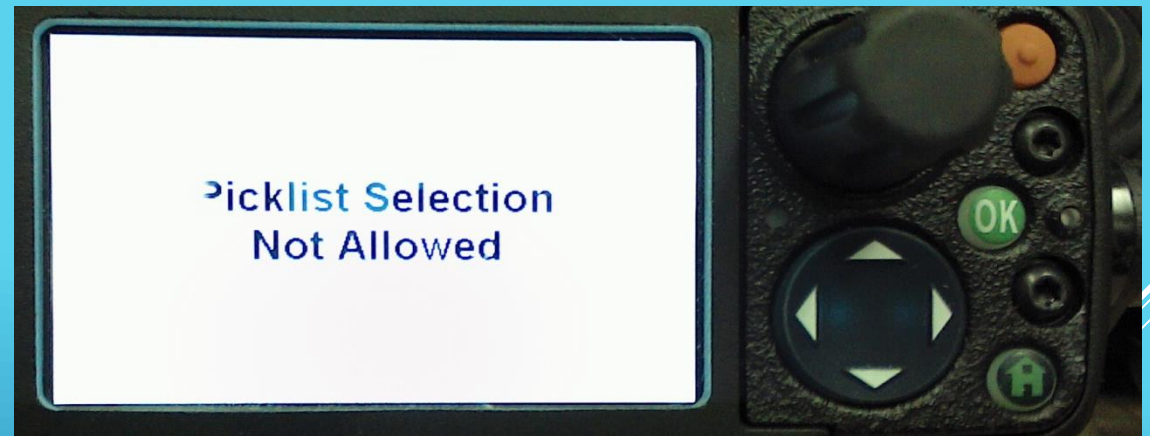

CREATING A SCAN LIST

PRESS SCAN TO TURN SCAN ON/OFF

TO CREATE A SCAN LIST PRESS MENU

USE ARROW PAD TO FIND "CHANNEL SCAN LIST"

PRESS ENTER/OK TO SELECT

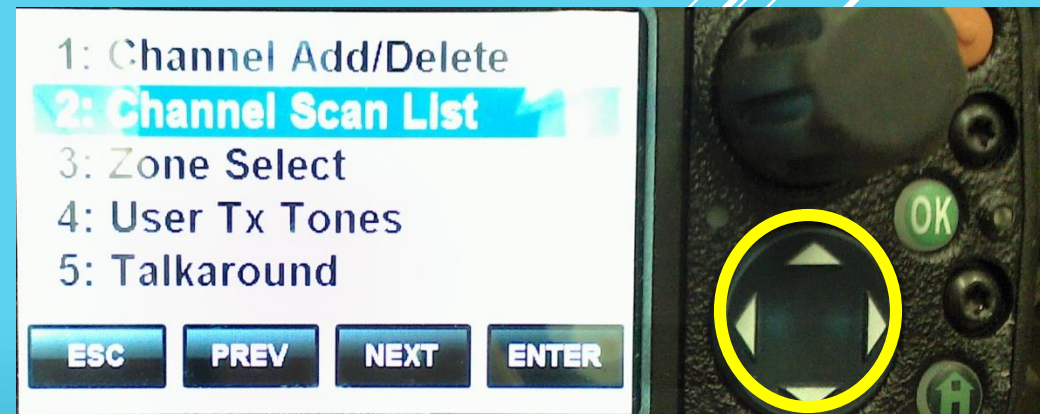
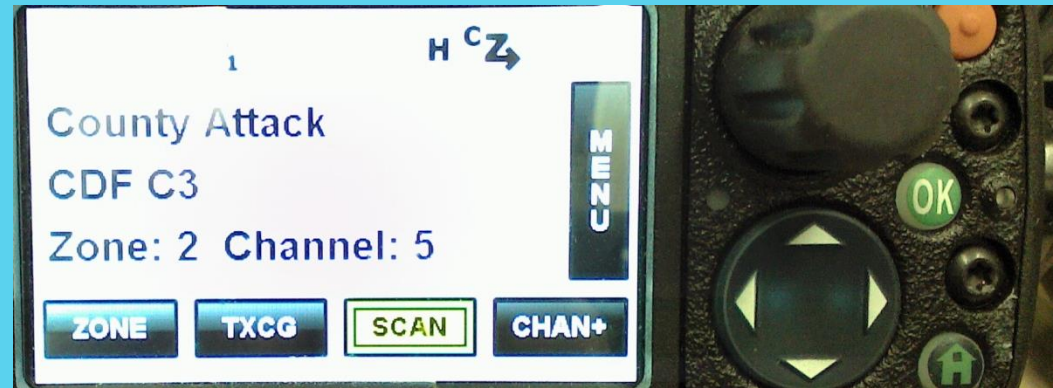

CREATING A SCAN LIST

- ▶ SELECT OR UNSELECT CHANNELS IN THE GROUP USING THE +/- BUTTONS
- ▶ SELECTED WILL SHOW A CHECKMARK
- ▶ SELECTING A CHANNEL TWICE WILL SHOW A "V". THIS IS A FEATURE THAT COULDN'T BE REMOVED AND WONT AFFECT SCAN OPERATION.

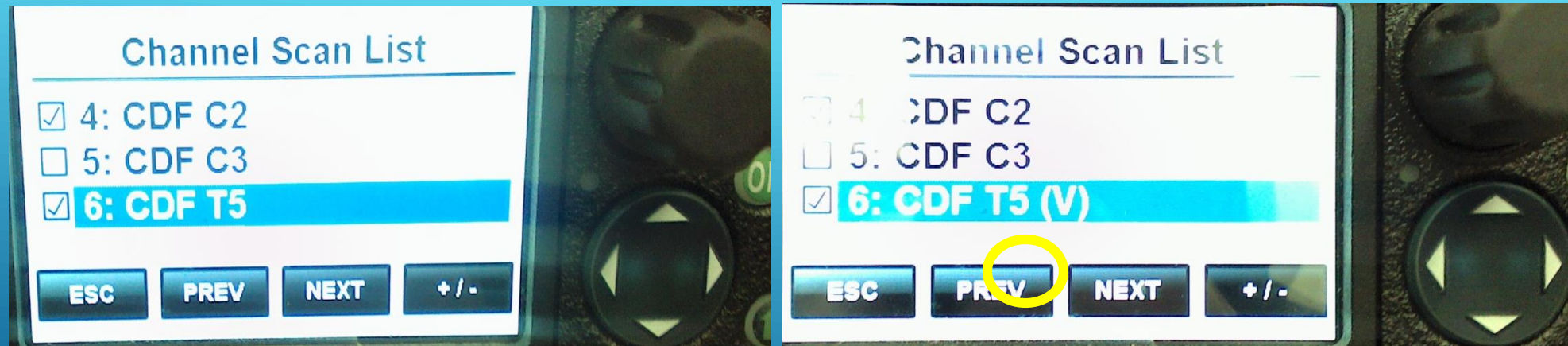

FLEET MAP REVIEW

- ▶ BOTH KENWOOD AND KNG RADIOS USE THE BLUE PAGES
 - ▶ KENWOOD IS LIMITED TO NON SHADED CHANNELS WHILE THE KNG USES ALL
 - ▶ ENSURE YOUR VEHICLE HAS THE MOST RECENT VERSION
- 
- A decorative graphic consisting of several parallel white lines of varying lengths, slanted diagonally from the bottom right towards the top right, set against a blue gradient background.

CREATING A COMMAND GROUP

- ▶ COMMAND GROUPS ARE ASSIGNED NUMBERS UNLIKE THE KENWOODS “VIRTUAL GROUP”
- ▶ COMMAND GROUPS WILL BE LISTED IN #18 AND 19
- ▶ COMMAND GROUPS ARE A CUSTOM GROUP WHERE YOU CAN COPY AND PASTE CHANNELS FROM ANYWHERE IN YOUR FLEETMAP.
- ▶ BEST BENEFIT IS WHEN ON AN OUT OF COUNTY STRIKE TEAM.
- ▶ REMINDER TO USE FLEETMAP TO AID IN FINDING CHANNELS

CREATING A CMD GROUP

- ▶ AFTER FINDING CHANNEL PRESS THES BUTTON LABELED “CHAN +”
 - ▶ SELECT CMD GROUP 1 OR 2
- 
- A decorative graphic consisting of several parallel white lines of varying lengths, slanted diagonally from the bottom right towards the top right, set against a blue gradient background.

Kenwood TK-790 VHF Mobile Radio



KENWOOD MOBILE RADIO CONTROL HEAD (TOP HALF)

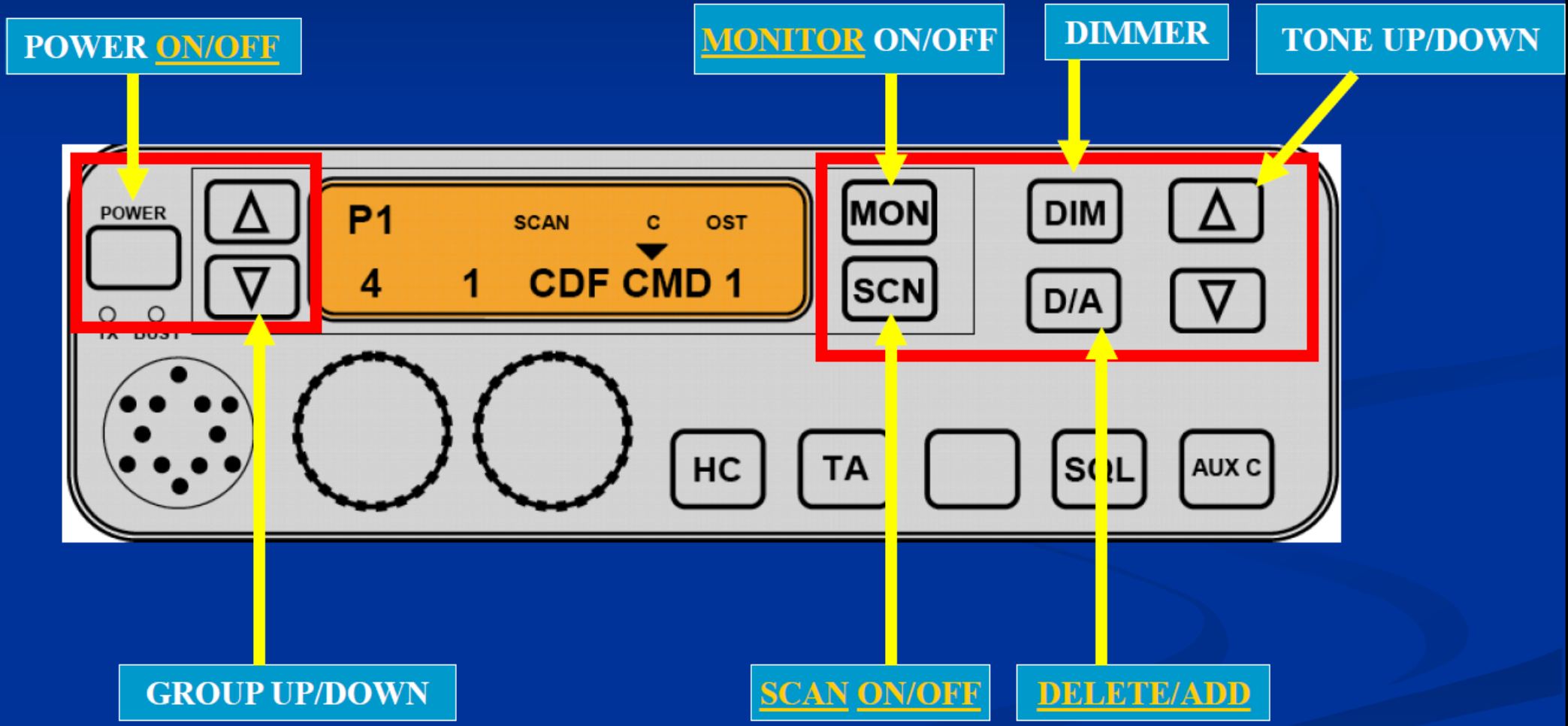

KENWOOD MOBILE RADIO CONTROL HEAD (LOWER HALF)

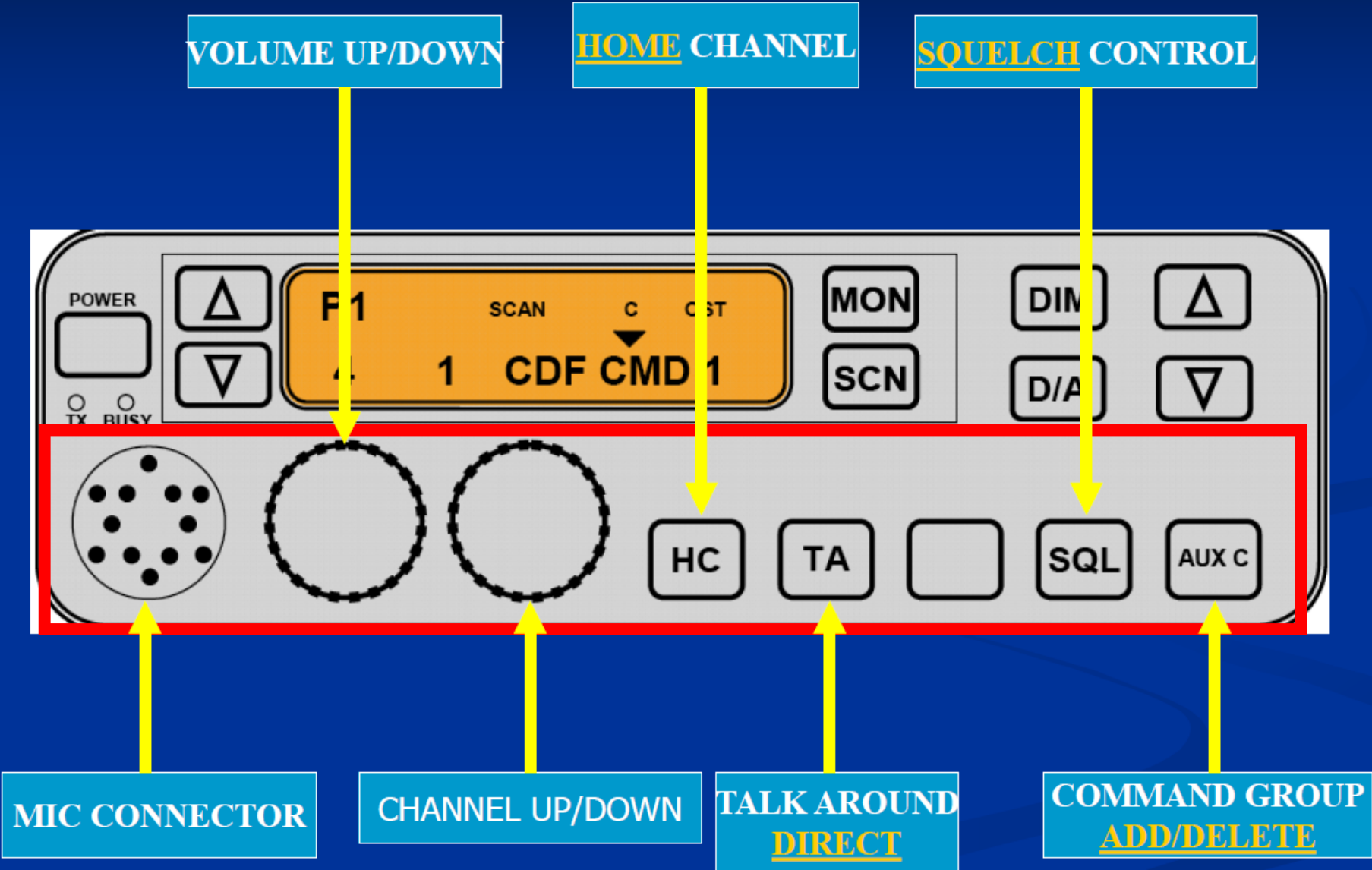

DISPLAY AREA

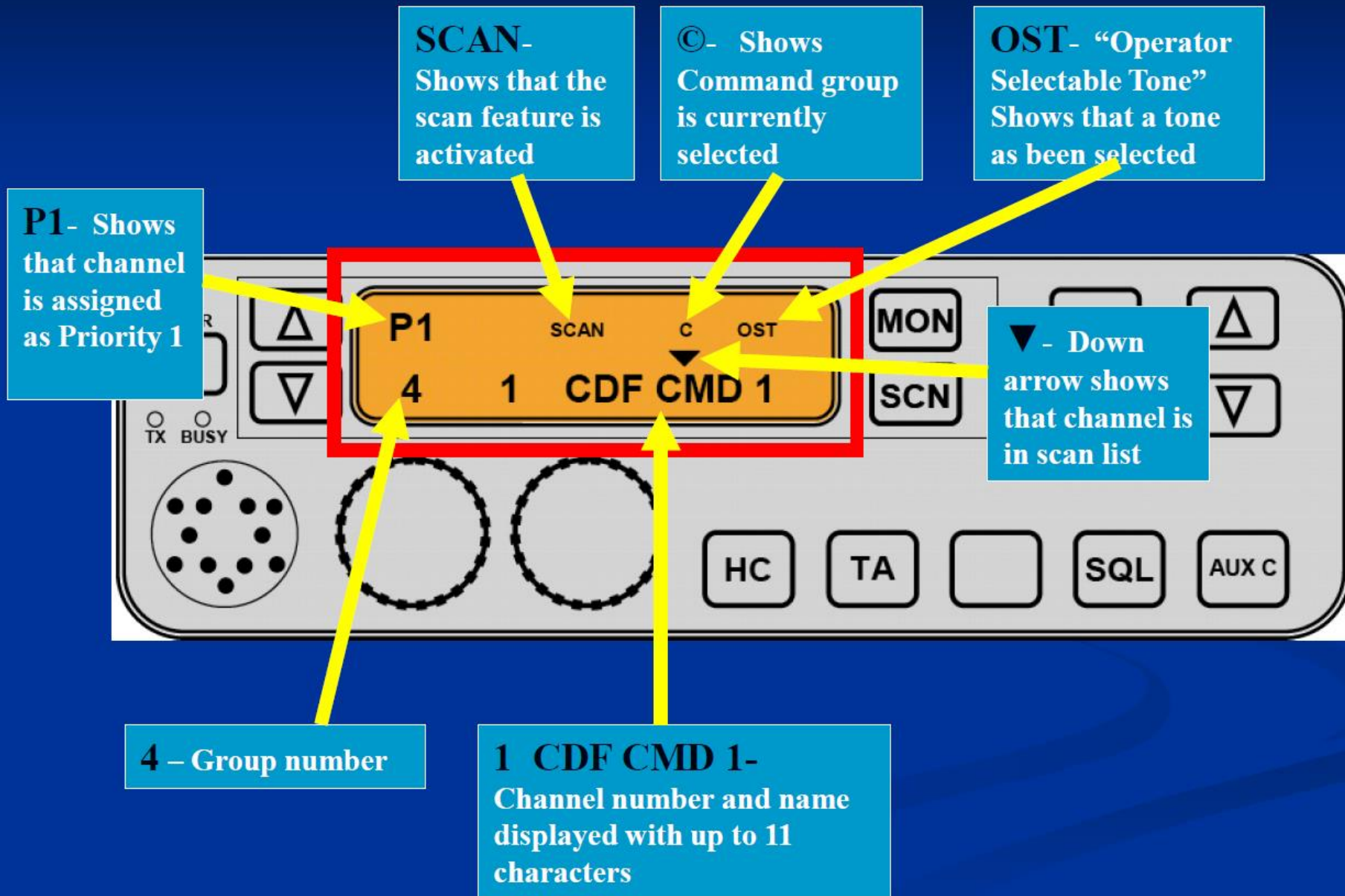

Scanning Function

1. Confirm which group you are going to scan

6. Press SCAN to start the scanning sequence, SCAN icon will appear

2. Make sure SCAN is OFF (Press) SCAN button

4. Press D/A button. The down arrow icon appears in the display, that channel is now in the scan list

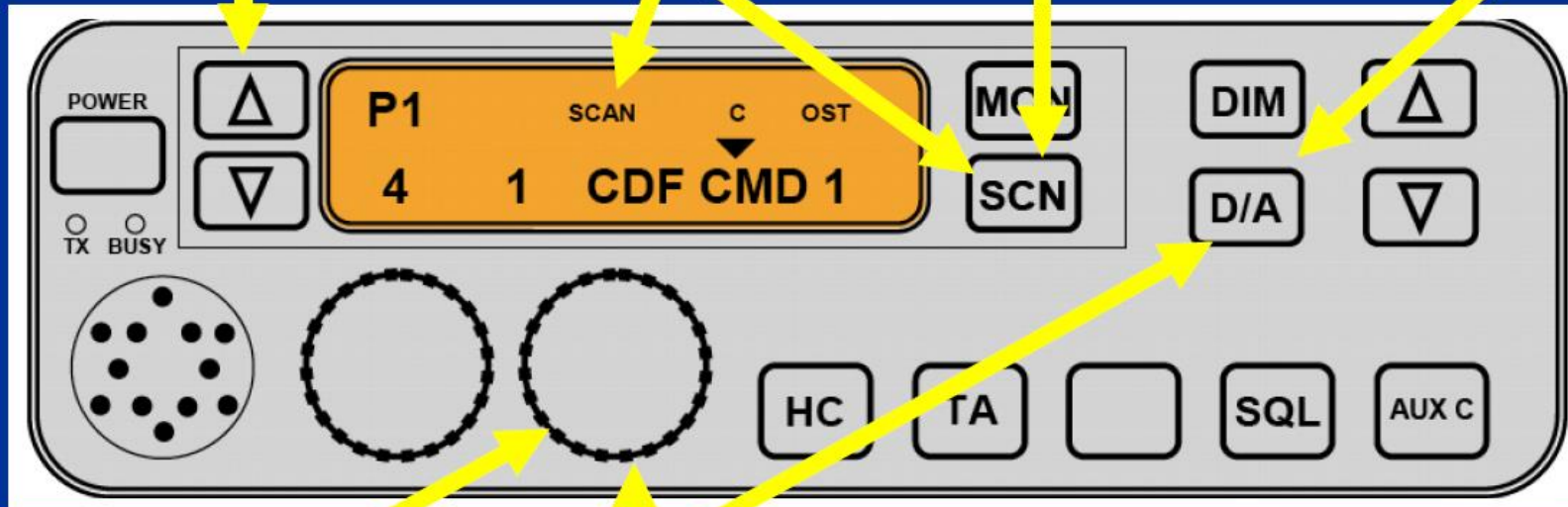

3. Rotate channel SELECTOR knob to the channel you want to add to scan

5. Move on to the next channels to add, repeat number (4.) until all desired channels are selected

Note: You can only scan one group at a time. You cannot scan multiple groups

Command Groups

4. Press this down arrow until a beep sounds and the © icon appears in the display. You are now in the “operator built” command group

5. This Icon will be displayed if Command group selected and disappear when the group is deleted

3. Press and hold the [AUX C] button until you hear a short beep and a momentary © icon appears on the display.

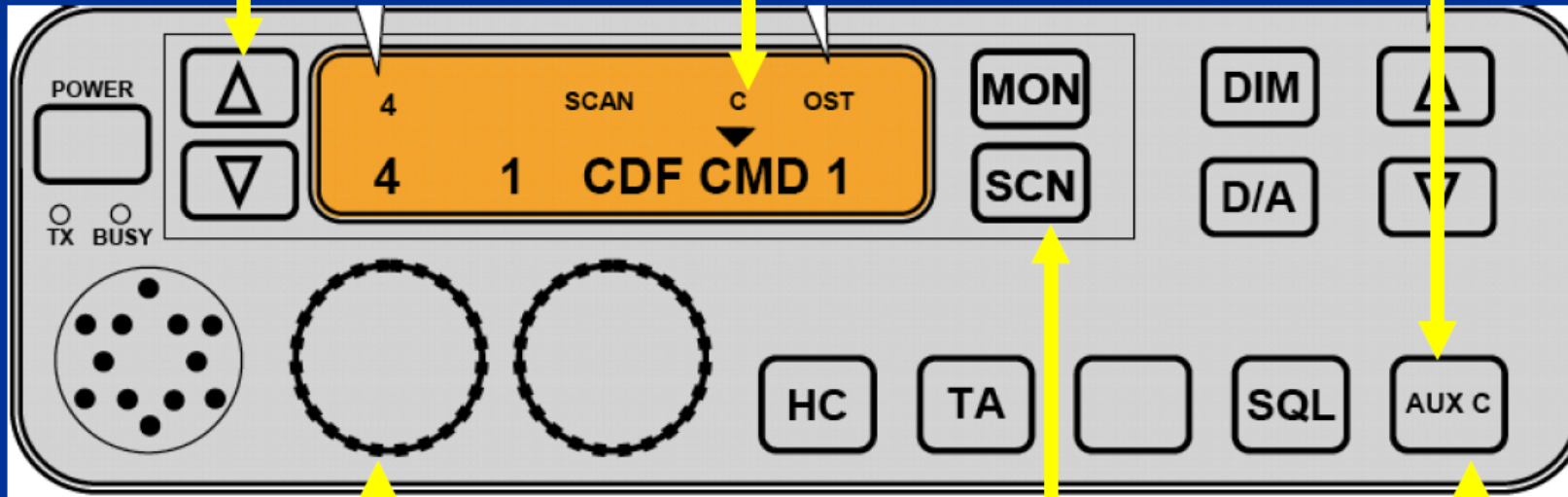

2. Use the channel select knob to dial up the desired channel to add to the command group from any group in the radio.

1. To use this command group, first turn the Scan off.

6. To remove channels from the command group press [AUX C] until the channel disappears and you hear a short beep.

Selecting Tones

TONE CURRENTLY
SELECTED ON
CHANNEL

THIS IS A REMINDER THAT
OST IS ON: OPERATER
SELECTABLE TONE (PRE-
PROGRAMMED TONES FOR
CERTAIN CHANNELS – SDFD
1,2, AND 4, TONE 8

SELECT DESIRED
TONE USING THESE
ARROW KEYS

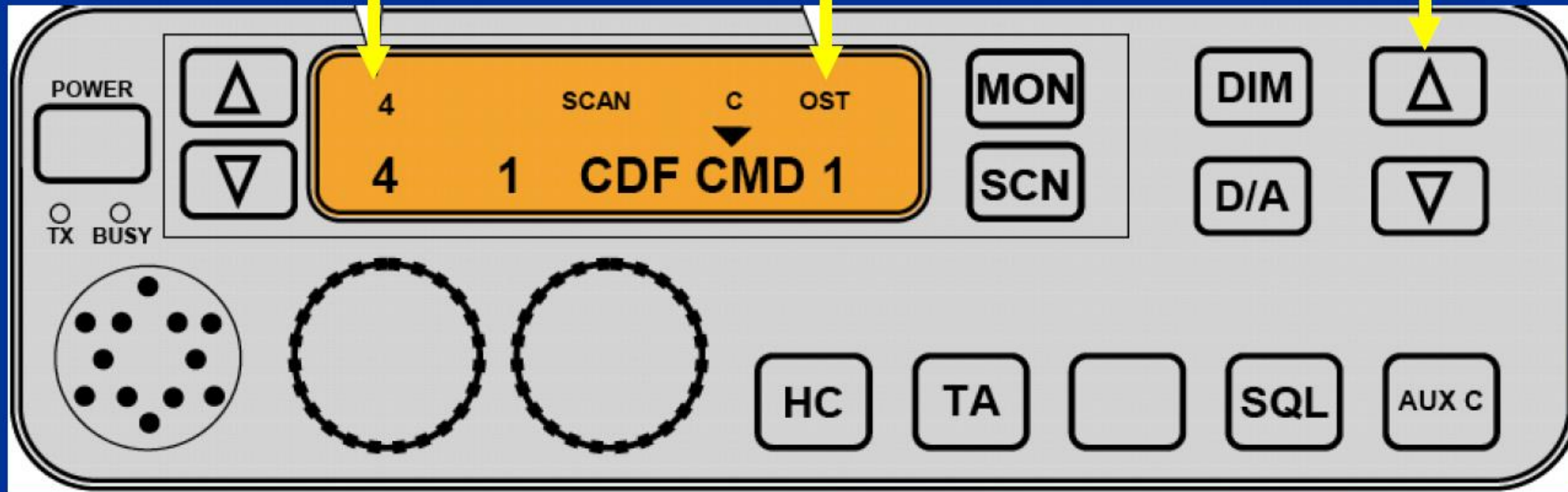

FIRE SCENARIOS

1. Type-1 Strike Team to Penasquitos Canyon

- XSD CMD 4
- XSD TAC 3
- XSD TAC 4
- XSD A/G
- VFIRE23
- AIR GUARD

FIRE SCENARIOS

2. Type 3 Strike Team to San Pasqual MTZ

- CDF CMD 1, TONE 11
- CDF TAC 5
- CDF TAC 8
- CDF A/G 2
- AIR GUARD

FIRE SCENARIOS

3. Type-1 Strike Team to Big Bear, USFS Incident

- **CMD FS BDF, Tone 6**
- **FS R5 T5**
- **NIFC Tac 2**
- **BDC A/G**
- **AIR GUARD**
- **Travel Channel CESRS DIR**