

High-Rise Firefighting

31

Section IV- Technical Operations



High-Rise Construction Features

San Diego High-Rise Buildings

High-Rise Firefighting Priorities

High-Rise ICS Positions

SDFD High-Rise Firefighting Tactics



Intentionally Left Blank



Chapter 31 Table of Contents

Objectives	31-1
Introduction.....	31-2
High-Rise Building.....	31-3
High-Rise Construction Features.....	31-4
First Generation High-Rise - 1800's to 1900's.....	31-4
Second Generation High-Rise - 1920's to 1951	31-4
Third Generation High-Rise -1951 to Present (Post WWII).....	31-5
San Diego High-Rises.....	31-7
Existing High-Rise - 1927 to mid 1970's	31-7
Life Safety High-Rise - 1974 to Present.....	31-8
SDFD High-Rise Firefighting.....	31-9
High-Rise Fire Priorities	31-10
Personal Safety	31-10
Establish Command Structure:	31-10
Rescue.....	31-11
Locate and Assess the Scope of the Fire.....	31-11
Confine and Extinguish the Fire	31-12
Property Conservation	31-12
High-Rise ICS.....	31-13
SDFD High-Rise Response	31-13
High-Rise Assignments	31-14
Fire Attack.....	31-15
Primary Responsibilities.....	31-15
Upon Arrival	31-15
Firefighter Ascent.....	31-19



- At the Fire Floor 31-20
- Lobby Control..... 31-31
 - Primary Responsibilities 31-31
 - Control All Entry and Exit Points 31-32
 - Establish Accountability System 31-32
 - Elevator Control..... 31-32
 - Unlock Stairwell Doors/Obtain Keys 31-32
 - Direct Crews To Appropriate Stairwell/Elevator 31-33
 - Systems Control..... 31-33
- Staging 31-34
 - Primary Responsibilities 31-34
 - Accountability..... 31-34
 - Location and Facilities..... 31-35
 - Rapid Intervention Crew Functions (RIC)..... 31-36
- Rescue Group..... 31-37
 - Primary Responsibilities 31-37
 - Rapid Ascent Tactics..... 31-38
 - Search Priorities..... 31-39
 - High-Rise Search Procedures 31-39
- Ventilation Group..... 31-41
 - Primary Responsibilities 31-41
 - Pressurization..... 31-41
 - High-Rise Ventilation Fundamentals 31-42
 - High-Rise Smoke Handling Systems..... 31-44
 - High-Rise HVAC Systems..... 31-46
 - Ventilation Group Tactics 31-46
 - Ventilation Strategy..... 31-47
- Systems Control 31-49
 - Primary Responsibilities 31-49



Systems Control Responsibilities	31-50
Elevator Operations	31-54
Primary Responsibilities	31-54
Elevator Features	31-55
Safe Firefighter Elevator Operations	31-57
Building Fire Pump Operations	31-59
Primary Responsibilities	31-59
Fire Pump Checks	31-60
Water Supply	31-61
Primary Responsibilities	31-61
Pump Pressures	31-62
Safety Tips	31-62
Base	31-63
Primary Responsibilities	31-63
Base Operations	31-63
Ground Support	31-65
Primary Responsibilities	31-65
Transport Manager	31-65
Apparatus and Equipment Manager	31-66
Air Supply Manager	31-66
Summary	31-67
Media & Link Index	31-69
References	31-70
Credits	31-71
Revisions/Updates	31-72





Objectives

- Identify construction features of first, second and third generation high-rises
- Explain the differences between existing high-rises and life safety high-rises
- Explain the resources dispatched on a high rise response
- Identify the positions required in the high-rise ICS system
- Explain the function and responsibilities of Fire Attack
- Explain the function and responsibilities of Lobby Control
- Explain the function and responsibilities of Staging
- Explain the function and responsibilities of Rescue Group
- Explain the function and responsibilities of Ventilation Group
- Explain the function and responsibilities of Systems Control
- Explain the function and responsibilities of Elevator Operations
- Explain the function and responsibilities of Building Fire Pump Operations
- Explain the function and responsibilities of Water Supply Group
- Explain the function and responsibilities of Base
- Explain the function and responsibilities of Ground Support



Introduction

The potential complexities of a significant high-rise fire cannot be overstated. Historically, San Diego, like other municipalities across the nation, has been successful in combating compartmentalized fires in residential high-rise buildings, [Figure 31-1](#). However several large cities including New York, Philadelphia and Los Angeles have found themselves combating un-compartmentalized commercial high-rise fires, [Figure 31-2](#). These fires are the result of modern construction practices that allow for expansive, un-compartmentalized floor plans and wide-open spaces. Although these buildings do have advanced fire protection systems and sprinklers it is inevitable that failures occur. Therefore we need to prepare for the worst and understand that a fire in an un-compartmentalized commercial high-rise can be similar in fire loading to a large commercial structure fire in a supermarket or warehouse.



Figure 31-1 Compartmentalized Fire

For example a commercial high-rise building 100' x 100' equals 10,000 sq ft of floor space. Involve half of it in fire and you have 5,000 sq ft. With a medium fuel load factor, this fire will require 1500-1666 GPM to extinguish. Coupled with the fact that ventilation options are quite limited in a high-rise, thermal radiation feedback is tremendous and there's no easy escape for occupants or firefighters means the challenge we face is tremendous. Pre-planning and training are the key ingredients for success.



Throughout this chapter the terms compartmentalized and un-compartmentalized are used. Residential high-rises are typically compartmentalized with openings to the outside and by their nature pose less of a fire problem. Commercial high-rises are typically un-compartmentalized with concealed voids and lack openings to the outside, all factors that contribute to rapid fire spread. Generally speaking this chapter speaks to the dangers of commercial un-compartmentalized high-rises. When speaking to residential high-rise issues it will be specifically mentioned.

High-Rise Building

A high-rise building is technically defined as a building 75' or taller. A more practical way to define a high-rise is any building that exceeds the reach of our tallest ladder. SDFD has 105' aerial ladders, however, when you consider factors such as setback, obstructions and climbing angle it's easy to see that a lot of ladder can be eaten up in a hurry.

When a high-rise fire occurs two significant issues are encountered. First it's difficult for the occupants to get out, even on a good day at lunch time stairwells can get crowded. Add the chaos created by smoke and potential complications such as power failure and it's clear that masses of fleeing people will complicate matters.

The second significant complication is the difficulty in accessing the fire. Firefighters will inevitably have a delay in getting to the fire due to reflex time. Imagine having to climb 30 stories in full gear and then having to fight fire, a herculean task. Remember fires can double in size every 90 seconds under ideal conditions. Additionally, firefighting resources are limited simply because you're operating from a standpipe system in a remote location. Based on these factors it's easy to see that a high-rise fire is very different from the majority of fires we fight on a regular basis.



Figure 31-2 Uncompartmentalized Fire

Reflex Time

Time it takes to get to the fire from the street level



Figure 31-3 Flights of stairs, heavy equipment, and evacuating civilians all slow the reflex time in high-rise fires



High-Rise Construction Features

Based on the era in which a building is constructed we can make very general assumptions that will help guide our firefighting strategy and tactics.

First Generation High-Rise - 1800's to 1900's



Figure 31-4 Monandock Building 1891, Chicago

First generation high-rise buildings started to appear in the late 1800's and early 1900's, [Figure 31-4](#). The catalyst for going upward came from Elisha Otis who invented a safe elevator system and advancements in building materials. This era of building is identified by exterior walls of reinforced masonry (typically concrete), and brick or stone often decorated with cast iron facades. The walls are very thick as they are the load bearing components; 12 inches thick to support the first floor with an additional 4 inches of thickness required to support each additional floor was the rule. This limited the buildings height and typically they do not exceed 10 floors.

These first generation buildings did not have the luxury of learning from the past and therefore little thought was given to fire protection. Unprotected cast iron columns, steel beams, wooden floors, and unprotected vertical openings are commonplace. The result was several catastrophic fires and collapses that spurred interest in providing fire protection and engineering controls to enhance life safety.

Second Generation High-Rise - 1920's to 1951



Figure 31-5 Empire State Building 1931, New York

This era in high-rise building construction resulted in buildings that incorporated the many lessons learned from the first generation and the result is buildings that effectively resisted fire. These buildings are steel framed structures with encased beams and columns in masonry (often concrete) which provide excellent protection against fire, [Figure 31-5](#). Other commonly found features include the use of non-combustible materials throughout, compartmentalization, and concrete floors securely joined to the walls with no gap. Vertical shafts are protected with proper closures and egress is greatly enhanced with fire tower stairwells that incorporated an atmospheric break between the building and the stairwell, called a smoke tower.

Smoke Tower

A smoke tower is a stairwell found in older high-rise buildings that is typically separated from the building proper by a vestibule, [Figure 31-6](#). This vestibule was either enclosed and vented, or open to the outside. The occupant would open a door from the floor, pass through a vestibule and enter an enclosed stairwell. In center core construction a form of the smoke tower can be found in buildings constructed between 1951 to early 1970's. Center core smoke towers by virtue of their location are mechanically vented to the outside rather than having an open vestibule.



The smoke tower very effectively keeps smoke out of stairwells. However, smoke towers by virtue of their negative pressures, have inherent associated risks because they draw fire to you. Remember that fire will always seek an area of lower pressure. When mounting a fire attack from a smoke tower you will be drawing the fire toward your position.

The smoke tower was phased out due to tests conducted in the late 60's and early 70's that demonstrated pressurization was more effective than ventilation in maintaining smoke-free conditions. Pressurization pushes the fire, smoke, and heat away from advancing firefighters. If given a choice always attempt to mount an attack from an area of high pressure.

Compartmentalization and small floor plans were the norm due to the dependence upon load bearing columns and the need for natural ventilation and lighting. In fact a 1933 ad for the RCA building in New York stated "that no desk was farther than 35 feet from a window" and unlike a modern high-rise the windows opened. These operable windows provided excellent ventilation for firefighters as well as leakage, even when closed, minimizing the stack effect.

Stack Effect

The stack effect is the natural movement of air within a building caused by differences in interior and exterior temperatures. The more sealed a building is and the greater the temperature differences, the greater the stack effect. See ventilation chapter for greater detail.

Third Generation High-Rise

-1951 to Present (Post WWII)

In 1951 a significant change in high-rise design occurred with the development of the curtain wall as well as technological advances in environmental control systems (central HVAC systems) and the invention of fluorescent lighting.

Smoke control panels eliminated the need for operable windows. This resulted in the sealing up of buildings which dramatically enhanced energy efficiency. Center core construction was born out of these developments and became the prevalent method of high-rise construction.

Center Core Construction

Center core construction does not rely on widely spaced load bearing columns as had been the practice in earlier generations of high-rises. Rather, these buildings utilize a steel framework and trusses to transmit loads to a center core made of reinforced concrete (does not always have to be in the center, can be side-core but the principle is the



Figure 31-6 Smoke Tower with outside vestibule

Curtain Wall

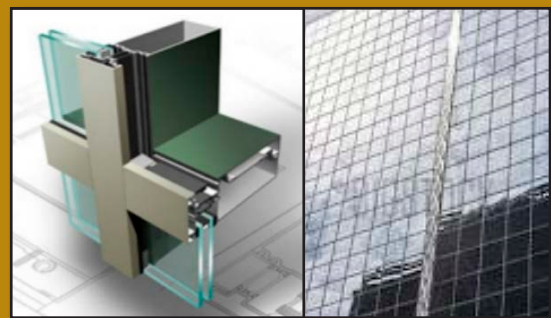

A non-load bearing wall attached to the load bearing lightweight steel framework utilized in high-rise construction, it basically keeps the weather out and is typically made of glass or some veneer such as stone. An inherent hazard of curtain walls is the gap that exists between the curtain wall and each floor of the building. If not properly fire stopped vertical fire extension can occur.

same). The core houses all of the building's essentials including elevator shafts, HVAC shafts, utilities and stairwells, [Figure 31-7](#).

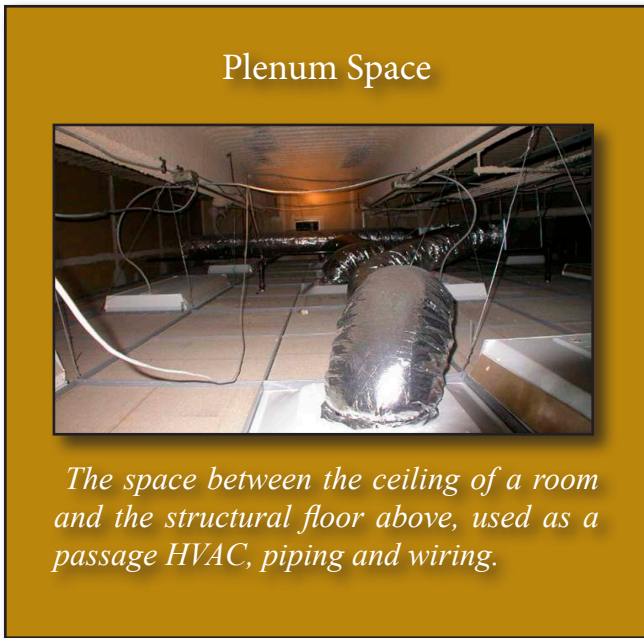

Plenum Space

The space between the ceiling of a room and the structural floor above, used as a passage HVAC, piping and wiring.

Center core construction enables designers to have extremely large open floorplans, ending the era of compartmentalization and its inherent benefit to life safety. An additional technological boon was the ability to protect steel structural members with spray-on fireproofing rather than concrete as had been past practice. This resulted in significantly lighter construction and lower costs. As an example the Empire State Building (opened in 1931) weighed in at 23 lbs per cubic foot and a modern high-rise comes in at 8 lbs per cubic foot.

Modern buildings with HVAC systems, communications gear and other utilities require an avenue of travel. This resulted in a new very hazardous construction feature. The plenum, created by the utilization of steel truss floor/ceiling assemblies, is a void space concealed overhead/underfoot behind drop ceilings. This void space often lacks fire-stop-

ping and can remarkably account for 25% or more of the total floor volume. This can obviously contribute to fire extension and reinforces the precaution to frequently check overhead for fire.



Figure 31-7 3rd Generation High-Rise, San Diego

Drawbacks to post WWII high-rise buildings:

- Lack of compartmentalization
- Gaps in the curtain wall leading to vertical extension
- Unprotected overhead void spaces (plenum)
- Lightweight construction with spray-on fire proofing of structural members

Improvements in post WWII high-rises:

- Equipped with early detection alarm systems
- Effective built-in fire protection systems (sprinklers/standpipes)
- Smoke management systems that utilize pressurization rather than ventilation (smoke tower) to maintain smoke free environments

These various features have of course led to enhanced occupant and firefighter safety. However, it's important to note that a building on fire is in a state of demolition and systems should be expected to fail and contingency plans should be made. By understanding the characteristics of each era of construction we can anticipate potential problems and develop effective solutions.



San Diego High-Rises

The first high-rise in San Diego was the El Cortez built in 1927 rising 14 stories, [Figure 31-8](#). As a pre WWII building, it is highly compartmentalized with protected structural members and operable windows. Since then 148 additional high-rise buildings have been built. Over time renovations have occurred in these buildings and fire protection systems have been updated. In fact the vast majority of high-rise buildings in San Diego are equipped with fire sprinklers. However it's important to note that several significant high-rise fires around the country have occurred in sprinkler-equipped buildings. Common reasons for sprinkler system failure include: being shut down (maintenance or malicious), partial coverage, and unanticipated changes in fuel loading due to renovations or changes in occupancy. Here are a few examples of sprinkler-equipped high-rises that suffered significant fires:

- 1988 First Interstate Los Angeles,
- 1991 One Meridian Plaza Philadelphia
- 2007 Deutsche Bank New York.

In San Diego we refer to our high-rise buildings as either existing or life-safety buildings. The classification of existing or life safety allows us to make some general assumptions about the fire protection systems in the building.

Existing High-Rise - 1927 to mid 1970's

Existing high-rise buildings in San Diego are Type I non-combustible construction, [Figure 31-9](#). Refer to pre and post WWII construction characteristics. Buildings will likely be equipped with:

- Standpipe systems and in most cases a sprinkler system (a small percentage of non-sprinkler equipped buildings remain). Standpipes will be equipped with pressure reducing valves and/or devices.
- Floors will have two means of egress and keys to stairwell doors will be available.
- An approved warning system or public address system
- Phase II elevators
- Smoke towers

Pre-planning is essential, as buildings are renovated the builders will upgrade the fire protection systems as mandated and the building may have significant improvements in fire protection systems.

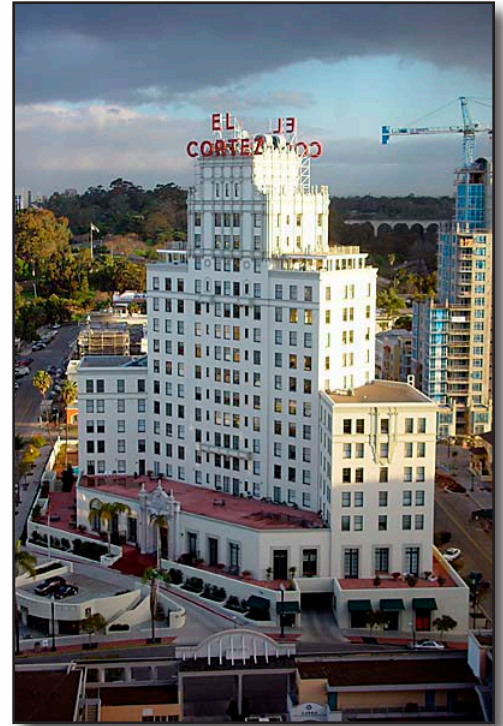

Figure 31-8 El Cortez Hotel - San Diego's First High-Rise, 1927



Figure 31-9 San Diego City Hall - Existing High-Rise



Life Safety High-Rise - 1974 to Present



Figure 31-10 San Diego's "Electra" Residential Life Safety High-Rise, 2007

Life safety high-rise buildings incorporate extensive fire-protection systems and engineering that enhance occupant safety and firefighting. These buildings are Type I non-combustible construction, [Figure 31-10](#). Refer to post WWII construction characteristics.

Life Safety High-Rise Features

- Fire control room
- Combined sprinkler-standpipe system equipped with pressure reducing valves and/or devices
- Fire pump
- On-site water supply
- Knox box
- Emergency back-up power supply
- Emergency lighting
- Public address system
- Communications systems for firefighters
- Dedicated landline phone
- Automatic stairwell unlocking
- Phase II elevators
- Smoke management systems utilizing pressurization

Emergency Operations Manual

High-rise buildings should have an Emergency Operations Manual. This manual provides information to responders about the various systems in the building, floor plans and pertinent phone numbers. It will likely, but not always be in the fire control room. During pre-planning check with building engineers and review this document.

Knox Box



Locked box that only the FD can access located in a prominent location usually near the entrance of a building that contains building access keys.



SDFD High-Rise Firefighting

Throughout this chapter we will cover each of the essential firefighting functions at a high-rise fire. These core functions include:

- Fire Attack
- Lobby Control
- Staging
- Water Supply
- Ventilation
- Rescue Group
- Base
- Ground Support



[Link 31-1 SDFD High-Rise Worksheets/Envelope](#)

For each of the sections you will find a corresponding checklist that can be referred to at an actual incident. Each checklist is two sided, one side showing an organizational chart and how each function fits in. Below the org chart is the strategic objectives “big picture” for the Officer to review. On the flip side are the task level issues for the firefighters to refer to.

Lastly, be sure you have read the fire protection systems chapter prior to this chapter as high-rises and sprinkler/standpipe systems go hand and hand.



High-Rise Fire Priorities

San Diego Fire-Rescue Department follows the standard ICS format consistent with FIRESCOPE. Like other types of fires the acronym RECEO-VS guides our fireground operations at high-rise incidents. Utilizing the recognized terminology and standardized format on small incidents will give you practice and familiarity that will prove invaluable when a larger scale incident occurs.

Personal Safety

The IC will ensure all members wear appropriate PPE and have radios. Radio communications within a high-rise can be limited due to the extensive concrete construction. With that in mind monitor and work from the agreed upon “direct” channel (ex: CARS 1). This enables communication between crews because it eliminates the need for repeaters and goes directly from radio to radio. Lastly, the IC should ensure that a radio is continuously monitored for “emergency traffic.” A working high-rise fire will require several chief’s aides.



Figure 31-11 Organization and a strong command presence are key to a successful high-rise operation

Establish Command Structure:

The standard ICS format, in accordance with FIRESCOPE, shall be used for managing and coordinating operations at a high-rise fire. Initial assignments made to fire units on the first alarm include:

- Fire Attack Group
- Lobby Control
- Staging
- Water Supply Group
- Rescue Group
- Ventilation Group

As the incident grows and resources arrive on the subsequent second and third alarms, Base and Ground Support will be established as well as the augmentation of already established functions. It’s important to remember that a high-rise fire of any magnitude will be a significant event requiring tremendous organization and logistical support. Notable examples of the logistical demands include:

- One Meridian fire - 300 firefighters
- First Interstate fire - 383 firefighters
- LaSalle Bank fire - 400 firefighters
- Deutsche Bank fire - 275 firefighters



Reflex Time

Reflex time is the time it takes for you to ascend to the fire from the lobby. Anticipate where the fire will be by the time you have made it to the fire floor, stretched your lines, and made entry. Fires can double in size every 90 seconds under ideal conditions. Therefore, as a general rule of thumb, the IC should base decisions on where the fire will be in 30 minutes, not where it is upon your arrival.

Rescue

Occupant safety is the chief objective at any fire. However the most panicked occupants may not be the most threatened. People may be frightened but are likely to survive if trapped on exterior balconies of hotels or at the windows of residential high-rises if not threatened by the fire itself or experiencing heavy smoke conditions.

Such was the case at the DuPont Plaza Hotel fire in Puerto Rico in 1986. A great many occupants survived by taking refuge on the balconies during the fire in the main ballroom near the lobby/casino that resulted in 97 fatalities. Occupants in the most danger often include the people you don't see on arrival; those trapped on the fire floor, those trapped above the fire floor in the Fire Attack stairwell, as well as on the floor above the fire floor and the top floors of the structure. These occupants' primary cause of death is due to the movement of smoke and CO to upper floors.

Early reconnaissance of the building by ascending crews will help to determine rescue priorities. Total evacuation of a fully occupied high-rise is a very undesirable tactic, therefore an IC should keep in mind sheltering in place, partial evacuations, and creating safe refuge areas as potential solutions to occupant safety.

The IC should consider establishing a Rescue Group early on in the incident. Factors to consider when assigning resources to this function include the type of structure (for example, hospital, commercial or residential), under construction, time of day, potential occupant load, size and location of the fire.

Locate and Assess the Scope of the Fire

For obvious reasons, this function is of the utmost importance. It is imperative we know what we're dealing with and its potential. High-rises can conceal a significant amount of fire with no outward signs due to their sealed nature. Similarly, a contents fire in a residential high-rise with an open window may look dramatic on arrival. However, if occupants closed the door to the hallway upon fleeing it is likely that the fire and products of combustion will be confined to the unit of origin.



Confine and Extinguish the Fire

Like all fires we need to put it out. However, once firefighters have found the fire floor they will assess the size of the fire and make a decision as to attack or confine/compartmentalize the fire until the attack stairwell has been searched or the search is well underway. This risk/benefit decision is required because of numerous fatalities that have occurred attributed to carbon monoxide in stairwells above the fire floor. (Refer to the Fire Attack and Rescue Group parts of this chapter for greater detail on this subject).

Property Conservation

Attention should be given to preventing unnecessary property damage. When available, assign crews to the floor below the fire and assess for potential salvage issues. A key area to consider when considering property conservation/salvage is de-watering. Elevator shafts should not be used for de-watering; this damages elevators and removes them from service. Additionally, water put into the elevator shafts will make its way to the basement. This is highly undesirable as the basement often houses the fire pump and generator, both of which should be kept running at all costs.

Basements should be monitored for flooding and plans should be developed to deal with de-watering if required. Options for significant de-watering include the stairs or out the side of the building through natural or man-made openings and submersible pumps in the basement.



High-Rise ICS

Below is the foundation for the incident command system at a working high-rise fire that must be put in place. The following sections in this chapter will breakdown each ICS position in depth.

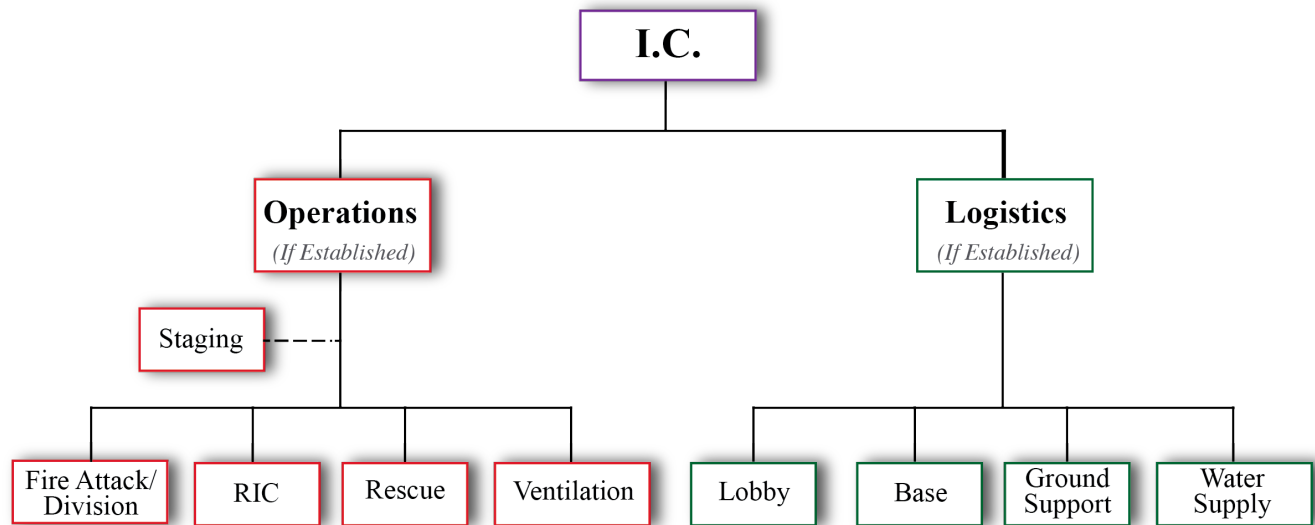

SDFD High-Rise Response

The following is the current SDFD High-Rise Fire response:

First Alarm

- 5 - Engines
- 2 - Trucks
- 2 - BC
- 1 - Heavy Rescue
- 1 - ALS Ambulance

Second Alarm

- 5 - Engines
- 2 - Trucks
- 2 - BC
- 1 - L/A
- Staff/EMS/Air Ops



High-Rise Assignments

Due to the dynamic nature of high-rise fires, the IC must allow for some flexibility when assigning units to specific tasks. That being said, there are certain assignments that must be made on all working high-rise fires in order to implement an effective and safe operation.

ALSBase – First Alarm

To assist crews responding on the first alarm to a high-rise fire with prioritizing their assignments, the acronym “ALSBase” may be used.

- A - Attack
- L - Lobby
- S - Staging
- Base - Base

This acronym is not an all inclusive assignment list (rescue, ventilation, and other key assignments are not included), but is intended to give the first arriving companies a quick reference to prioritize their duties at a high-rise fire. Similar to RECEOVS.

Recommended Assignments

The following is a more inclusive list of assignments that should be made at a high-rise fire. Again, each incident will be unique and ultimately the IC must prioritize which units are ultimately assigned to the following tasks.

1st Alarm Assignments

Fire Attack/Division

- Engine 1
- Engine 2
- Truck 1

Water Supply

- Engine 1 - Engineer
- Engine 2 - Engineer

Lobby

- Engine 3

Staging - RIC & A/O

- Engine 4

Rapid Ascent Team - Clear Stairwells

- Truck 2
- Heavy Rescue/USAR

Ventilation - Pressurize Stairwells

- Truck 1 - Engineer
- Truck 2 - Engineer

2nd & 3rd Alarm Assignments

Base

- Engine 6

Systems Control

Elevators

Fire Pump

Ground Support

Fire Attack Support/Relief Crews

Note: The engine and truck numbers represent the order at which they arrived at scene.



Fire Attack

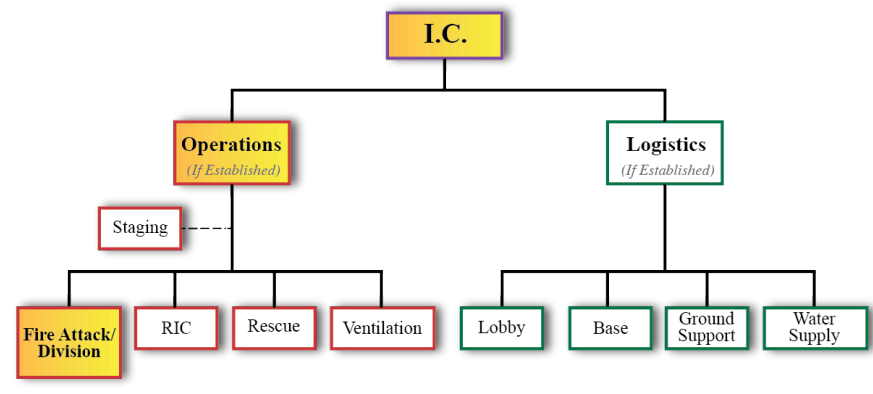

Primary Responsibilities

- Form Fire Attack Group (2 engines & 1 truck)
- Review alarm panel & level of alarms
- Identify attack & evacuation stairwells
- Locate & assess scope of incident
- Is stairwell search underway?
- Attack fire or compartmentalize fire
- Frequently check overhead for fire

Fire Attack's overall objective is to determine the location and scope of the fire in a timely fashion and if capable, attack the fire. When the task at hand is locating and assessing the scope of the fire, time is of the essence. However, it is equally important to take a few minutes in the lobby to properly gather information and assess the situation prior to your ascent. For example, carefully evaluating the alarm panel to locate the floors where the fire is and taking the time to assess the elevators' operation and safety will significantly save time and reduce fatigue in the overall operation.

The objectives for Fire Attack can be divided into three areas:

- What you do upon arrival
- What you do during ascent
- What you do upon reaching the fire floor

Upon Arrival

Upon arrival the first two engine companies and the first truck company to arrive at scene form up to make the Fire Attack Group consisting of nine fire-



fighters. The engineers from the first two engine companies remain with the apparatus to provide a water supply. The engineer from the first-in truck company is responsible for evaluating and providing ventilation.



Form-up and Gather Equipment

The firefighters assigned to the Fire Attack Group should gather the following standardized equipment and form up in the lobby area prior to ascent to the fire floor.

Standardized gear for both engines and trucks:

- Full PPE/SCBA and radios**
- FOG Guide/Checklists
- Spare SCBA bottles
- TIC
- High-rise escape pack
- Accountability box

- Forcible entry tools
- *Duct tape

Engine Specific Gear

- Hose and nozzle
- Standpipe kit

Truck Specific Gear

- Rescue saw and blades
- Pike Pole
- Extinguisher

Hose Selection 1 3/4" vs. 2 1/2"

Choosing the right hose and nozzle combination is a very important decision the Company Officer must consider prior to ascent. SDFD rigs carry both 1 3/4" and 2 1/2" hose for fire attack. The 1 3/4" hose for high-rise operations is folded into two "high-rise" packs that consist of 100' of hose with a high-rise nozzle, gated wye, a 2 1/2 to 1 1/2 reducer and 6' 2 1/2" whip, [Figure 31-12](#).

1 3/4" hose is quick to deploy, easy to handle and contains a low-pressure fog nozzle that can deliver approximately 170 GPM @ 75psi. The nozzle can also be broken down to a 7/8" slug tip that produces 160 GPM @ 50 psi.

2 1/2" hose shall be used with a 1 1/8" smooth bore tip and will produce 270 GPM @ 50psi and 240 GPM @ 40psi.



Figure 31-12 High-rise hose packs A (top) & B (middle) each consist of 100' of 1 3/4" hose with a high-rise nozzle (bottom)



Although it is slower to deploy and more difficult to maneuver, it delivers high GPM at low pressure.

The 2½” hose is not in pre-made packs and will have to be made into packs prior to ascent. This can be done quickly and the only thing needed is some white EMS duct tape, [Figure 31-13](#). If required it will be worth the time to make these packs.

If a fire is well compartmentalized (for example, contents of one small apartment or a copier room with no overhead extension) 1¾” hose would be a good choice because of its rapid deployment characteristics. However, if a fire is un-compartmentalized involving multiple units, overhead extension in the plenum, or has taken control of the hallway, 2½” hose is the appropriate choice.

Deploying 2½” hose in a high-rise may take 5 fire-fighters at a minimum to advance through a maze of cubicles or down a long hallway, but the high volume of water and tremendous penetration make the 2½” the correct tool for the job.



[Figure 31-13](#) Fifty foot sections of 2 1/2” hose can be made into hose packs with duct tape. Once at the fire floor they can be connected easily, the tape can be removed, then quickly flaked out and deployed



[Figure 31-14](#) Compartmentalized fires may be attacked using 1 3/4” hose



[Figure 31-15](#) Uncompartmentalized fires should be attacked using 2 1/2” hose

Compartmentalized vs. Uncompartmentalized



There are several methods to determine if the fire is compartmentalized or uncompartmentalized. A compartmentalized fire is typically found in residential high-rise buildings where individual units are sealed off from one another. Smoke or fire showing from a single window or balcony may also indicate a compartmentalized fire, [Figure 31-14](#); however, you must consider your reflex time and the possibility of it developing into an uncompartmentalized fire.



An obvious large body of fire seen upon arrival coming from multiple windows or floors also indicates that the fire is uncompartmentalized and large hose lines should be used, [Figure 31-15](#). However, this should not be relied upon as a sole indicator. With modern high-rise construction and airtight buildings, a large uncompartmentalized fire may be concealed with no outward sign of smoke or fire. Occupant/security guard reports, multiple alarms in multiple areas versus a single alarm, and commercial layouts are likely to indicate an uncompartmentalized fire.

If uncertain, err on the conservative side and take both 1 ¾” and 2 ½” hose. Remember the Fire Attack Group is comprised of 9 firefighters, so you have the resources to take both. Lastly, when considering which hose and nozzle combination, think about reflex time.

Nozzle Selection

VS

Why mention what a 2 1/2” with a 1 1/8” tip will flow at 40psi when we are supposed to pump it at 50 psi?

Remember that a building on fire is in a state of self-destruction and failures in key systems should be expected (USFA TR-082, Operational Considerations for High-rise Firefighting) and contingency plans should be made. Choosing a hose and nozzle combination that can deliver 238 GPM @ 40 psi enables you to deliver a lot of water with very little demand on the fire protection/stand-pipe system (in fact even at 30psi a smooth bore delivers an effective stream although this pressure is not recommended).

This may be highly desirable quality in the event pipes break, pumps fail, hose-lines connected to the FDC are cut by falling glass, power failures occur, PRV’s are not adjusted correctly and cannot be field adjusted, or any other number of other unforeseen events occur and compromise a well designed system.

The key to selecting the proper hose is to evaluate the problem, understand the various tools at your disposal and choose the right tool for the job. Hose and nozzle selection is a very important decision.



Check Alarm Panel

Prior to ascent, the Officer(s) should go to the alarm panel/fire control room to accomplish the following:

- Determine location, type and number of alarms
- Ensure stairwell auto-unlock is activated and/or obtain keys
- Obtain a red phone

Assess Elevators for Safety and Potential Use

Elevators should be quickly evaluated for safety to see if they can be utilized for ascending the building

- Refer to the elevator check list in the high-rise ICS envelope.
- If elevators were auto-recalled, sitting in the lobby with their doors open when you got there, you cannot use them for initial attack.
- Obtain elevator keys from the Knox Box, [Figure 31-17](#), Fire Control Room, or building representative.

Assess the Stairwells

The building's stairwells need to be located and evaluated for use. One stairwell should be dedicated for fire crews while a separate stairwell should be utilized for evacuating residents. Things to consider when identifying stairwells are:

- Does the stairwell have a standpipe?
- Does the stairwell have roof access (ideal for fire attack)?
- Does the stairwell service every floor?
- Is the stairwell overwhelmed with fleeing occupants?

Answering these questions will enable the Officer to make an informed decision about which stairwell is most appropriate for fire attack and which is best for evacuation. History has proven multiple times that occupants trapped in stairwells filled with products of combustion die from CO poisoning, often times far removed from the fire floor. This is why it is so important to designate an Attack and Evacuation Stairwell early in the incident. Occupants cannot be allowed to evacuate via the stairwell designated for attack purposes.

Firefighter Ascent

Prior to your ascent, leave an orange Accountability Board with your Crew ID tags in a visible place such as the security desk, stairwell door or elevator lobby. Once Lobby Control gets set up they will be looking for those tags to account for those crews already in the building.

While ascending either via stairs or elevator, stop at least every 5 floors to check on building conditions and get an idea of the floor layout. A floor layout plan is usually located in all elevator lobbies in the form of an emergency



Figure 31-16 Typical High-Rise Alarm Panel

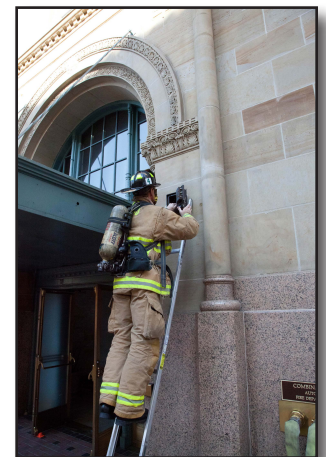

Figure 31-17 Obtain keys from Knox Box



Figure 31-18 FF's should check conditions every 5 floors when ascending the stairs

evacuation placard that will show your position in relation to the stairs. If it's helpful to you, remove it from the wall and carry it with you.

Communicate your findings to the IC as you ascend. This will help the Incident Commander make decisions on resource needs and formulating a fire-fighting strategy. Additionally other working groups will benefit from your updates as they prepare to begin their assignment.

Ascending the Stairs

Physical fitness is paramount; your ability to climb the stairs in a timely manner and be an effective firefighter is totally dependent on your personal commitment to maintaining a high degree of occupational fitness. Fitness will potentially save your life. The less fatigued you are, the more clearly you will think and the more effective you will be.

When ascending the stairs preventing heat exhaustion is vital. Company Officers may allow ascending crews to dress down their PPE as they climb. Simple things like not wearing your hood and keeping your jacket open will help keep you cool. However, your PPE must be donned if an IDLH is suspected/encountered and/or at the discretion of your Company Officer. You will be carrying quite a bit of gear; spread the weight out so one member is unduly burdened with weight. Your team is only as good as your most fatigued member. Remember to check the conditions and layout every 5 floors on your ascent.

Ascending via the Elevator

This is the ideal method of ascent; keeping firefighters from getting fatigued and reducing reflex time, which translates to less fire growth. Elevator use is permitted for initial attack operations when the fire is above the 7th floor AND the Elevator Operational Checklist is complied with.

At the Fire Floor

Once Fire Attack has arrived at the fire floor they will assume the designation of Division # (whatever floor they are operating on). For instance, if the fire is on the 12th floor, the Fire Attack Group will become Division 12. All crews operating on the 12th floor will report to Division 12. Of paramount importance is the transmission of an accurate size-up by the Division. Remember to include conditions found, initial actions being taken, resource needs and the location you have selected for Staging. Factor in reflex time and potential fire growth coupled with the type of building, occupancy type and time of day when requesting resources.

Fire Attack will confirm that the stairwell initially identified as the Attack Stairwell is still ideal for this purpose. Factors such as standpipe location and condition, fire size and intensity, or forcible entry issues may dictate a change in the tactics and require moving to another stairwell. Remember to avoid mounting an attack from a smoke tower, by design a smoke tower draws fire, it creates an area of low/negative pressure. Once a stairwell is committed to fire



attack it can no longer be used for occupant evacuation and all efforts should be made to keep occupants out.

A suitable area for staging, two to three floors below the fire floor, will need to be designated and the IC advised of its location. You should store any excess gear here as well as leave your orange Accountability Board with individual tags when you decide to mount an attack or enter an IDLH.

Connecting and Stretching Hose Lines

Hose lines should initially be connected to the standpipe in the stairwell one floor below the fire floor, [Figure 31-19](#). There are several reasons we don't connect the hose lines to the standpipe on the actual fire floor; doing so would create tremendous congestion in the event attack crews have to back off the fire floor in a hurry. Additionally, by hooking up one floor below the fire, it allows firefighters to retreat into the stairwell and down one floor and still have a charged hose line in place to protect themselves. Should fire conditions deteriorate, this leaves enough room for firefighters to close the door.

Prior to making your hose connections to the standpipe, always flush the standpipe as years of corrosion and other debris often accumulates in the piping. After flushing the system, attach the in-line pressure gauge (found in the standpipe kit) and then desired hoseline.

Charge the hoseline and ensure adequate water pressure is flowing from the nozzle in the stairwell, prior to entry on the fire floor. Utilize the in-line pressure gauge to confirm that proper water pressure is present at the standpipe outlet.

If you encounter low water pressure from the nozzle, consider the following:

- Ensure standpipe valves are open all the way.
- Remove kinks in hoseline.
- Ensure the building's fire pump or the Water Supply Group is supplying the correct pump pressure.
- Switch to a smooth bore nozzle - If using a low pressure fog nozzle (75psi) break it down to 7/8" slug tip and/or switch to a 2 1/2" with a 1 1/8" smooth bore (remember high GPM at low pressure). Smooth bore nozzles produce effective streams at pressures as low as 30 psi.
- If necessary, remove pressure-restricting devices and/or adjust the PRV to the necessary pressure. This should be done with the hoseline flowing water in the stairwell and leaving a firefighter stationed at the gauge to make adjustments as needed. *(Note: If restricting devices are removed, excessive pressures may occur in your hose lines. To avoid bursting your hose lines, you should consider leaving your nozzles cracked open).*
- All the above should be confirmed and performed in the stairwell prior to initiating fire attack operations. **(Refer to the Fire Attack checklist in the Highrise envelope as additional reference for help with low pressure).**



Figure 31-19 Hose lines should be connected to the standpipe 1 floor below the fire floor

If using 2 1/2" hose, expect 5 to 7 firefighters to effectively advance the hose line.

Standpipe Kit - Inventory



Minimum Standpipe Kit Inventory

- (1) 2 1/2" In-Line Pressure Gauge
- (1) 2 1/2" Stacked-Tip Smooth Bore Nozzle
- (1) Pressure Reducing Valve Adjustment Tool
- (1) Heavy Duty Bag

Note: At the discretion of the crews, additional items may be added to the bag:

- Door Chocks
- Duct Tape
- Spanner or Pipe Wrench
- Webbing for SCBA bottles
- Highrise Firefighting Envelope



The Task Force Tip In-Line Pivot Pressure Gauge is designed for use on standpipes or other 2 1/2" discharge outlets to allow firefighters to make proper adjustments to the PRV and or pump pressure. The pressure gauge has a pivoting joint that moves 20 degrees in either direction to prevent hose kinks. This pressure gauge should be installed directly to the discharge outlet prior to all hose and appliance connections.



The 2 1/2" Stacked Tip Smooth Bore Nozzle consists of six separate pieces:

1. 2 1/2" to 1 1/2" Reducer
2. 1 1/2" Pistol Grip Shut-off Butt
3. 1 1/2" Stream Straightener
4. 1 1/4" Tip
5. 1 1/8" Tip
6. 1" Tip

In-Line Pressure Gauge Connections



1 3/4" Hose Pack Connections

Flush standpipe system. Then connect the In-Line Pressure Gauge directly to the standpipe outlet. The gated wye from highrise hosepack "A" should be connected to the discharge side of the in-line pressure gauge next. All connections should be spanner tight.



2 1/2" Hose Connections

Flush standpipe system. Then connect the In-Line Pressure Gauge directly to the standpipe outlet. The 2 1/2" hose should be connected to the discharge side of the in-line pressure gauge next. All connections should be spanner tight.

Reading the Gauge & Adjusting the PRV

The In-Line Pressure Gauge will give a static pressure reading as soon as the standpipe outlet is opened. Do not make adjustments to the PRV based on this reading.

With water flowing, make note of the residual pressure reading on the gauge. If low pressure is noted it could be due to the following:

1. Valve not opened completely or kinks in hose.
2. Low pump pressure from Water Supply Group or from the building's fire pump. Make proper notifications to the Water Supply Group to boost the pump pressure supplied by the Engine Co.'s at the standpipe inlet.
3. Pressure Reducing Valve may be incorrectly adjusted or set. Use the PRV adjustment tool to increase the pressure. This must be done with water flowing while still in the stairwell, prior to starting fire attack.

If water pressure is too high, you can gate down on the standpipe outlet valve to achieve proper pressure and/or adjust the PRV to lower the pressure.

Reminder: NFPA 14 requires buildings built prior to 1993 provide 65 psi at the furthest standpipe outlet. Buildings built after 1993 are required to deliver 100 psi at the furthest standpipe outlet.



High-Rise Fatality Fires Above Fire Floor



MGM Grand 1980

61 of 85 fatalities were located above the fire in a high-rise tower.



NYC Residential Hi-Rise 1998

19th floor apartment fire, door left open 4 fatalities in stairwell between floors 27 and 29.



Cook County Administration Building 2003

12th floor fire, 6 fatalities in stairwell between floors 16 and 22.

Search Stairwell or Attack Fire (Risk/Benefit)

Prior to initiating an attack on the fire, the Fire Attack Group must do a brief risk/benefit analysis. The analysis involves determining if the benefit of attacking the fire outweighs the risk of flooding the stairwell with smoke and CO. Obviously it would be wise to attack a small fire with limited products of combustion or a fire contained to one room or unit. However, if a large portion of a floor is burning it would be prudent to compartmentalize the fire by keeping the door closed until a search of the attack stairwell above your position is complete or well underway. Once you open the door to advance the hose line, the stairwell will no longer be safe for evacuees. This exact scenario has killed many people.



Figure 31-20 Notching the bottom corner of the door will prevent smoke from entering the stairwell during fire attack

One method for reducing the amount of smoke and CO from entering into the stairwell while mounting a fire attack is to notch the door for the hose line, **Figure 31-20**. By using a rescue saw to notch the bottom corner of stairwell doors, you may still allow hose to pass and also close the door to keep smoke out. Additionally, firefighters should minimize propping open stairwell doors.



Pressurization of the stairwell is vital to your success and opening doors will minimize this effect.

Factors to consider when deciding whether it is prudent to attack the fire or attempt to compartmentalize the fire include:

- Size and intensity of the fire (for example, a rubbish/mattress fire, small compartmentalized apartment fire, versus a large portion of an open floor plan extending overhead or multiple units)
- Progress of the Rescue Group searching the attack stairwell
- Time of day and occupancy type

Attack the Fire

Once a decision to attack the fire is made, deploying the initial line is the most important single task; ultimately back-up lines of equal or larger size will be put in place. Back-up lines should come from two or more floors below the fire and may come from other stairwells depending on the mode of attack. Always consider opposing hose lines when developing attack strategies.

The most commonly utilized initial strategy is a frontal attack. However as the incident evolves and more information (such as floor plans) becomes available to the Incident Commander other attack options may be considered. These include:

- Frontal attack
- Flanking attack
- Defensive attack

As with all structure fires, remember to ensure adequate personnel are available to fill the role of I-RIC as outlined in the Operations manual prior to attack. The only exception is if a known rescue exists. Additionally, ensure individual accountability tags are left at staging, attached to an orange accountability board

Two unique hazards that the fire attack group must be aware of in a high-rise building are the plenum space and the wrap-around phenomenon, [Figure 31-21](#). Firefighters must ensure that they check the plenum initially and frequently for overhead fire. Remember the plenum is likely wide open and unchecked fire spread can occur.

With the advent of center-core construction a unique fire behavior phenomenon has been noted called the wrap-around phenomenon. Firefighters advancing on a fire may actually push the fire back around the core to their exposed backside. Therefore the positioning of a defensive line in center core construction is advisable.

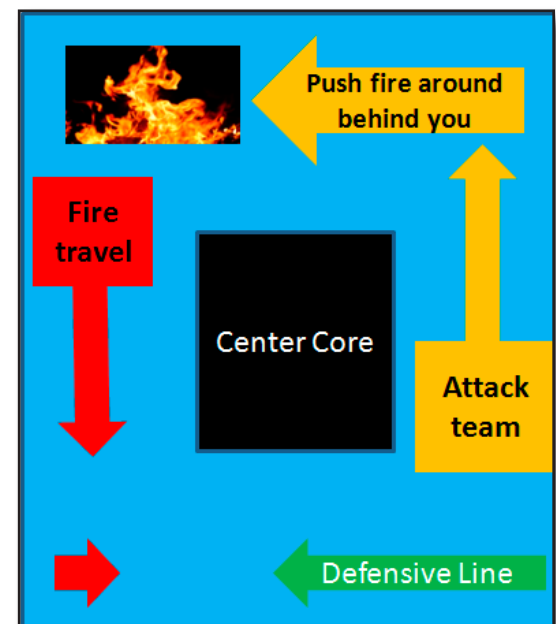

Figure 31-21 The “wrap-a-round” effect may be experienced in buildings with center-core construction



Compartmentalize the Fire:

If a significant fire and/or volume of smoke are present on investigation, waiting to ensure the stairwell above the fire floor is being searched or the search is completed may be most prudent. This is the crux of the risk-benefit analysis that Fire Attack will conduct in the stairwell.

The importance of stairwell search is well documented as far back as 1977 in Chief O'Hagan's (FDNY) landmark book *High Rise/Fire and Life Safety*. "If CO content of the fire gases is high, asphyxiation of escaping occupants within the stairway could occur."

- MGM Grand 1980 - 61 of 85 fatalities were located above the fire in a high-rise tower.
- NYC residential high-rise 1998 - 19th floor apartment fire, door left open 4 fatalities in stairwell between floors 27 and 29.
- Cook County Administration Building 2003 - 12th floor fire, 6 fatalities in stairwell between floors 16 and 22.

Chief O'Hagan's prediction regarding the dangers of CO was correct. The cause of death for all these victims was carbon monoxide poisoning:

Firefighter Fatigue

Rotation of firefighters directly involved in the firefight is vital to ensure the hose streams are continuously flowing. High heat and limited ventilation will create potentially grueling conditions and require that significant manpower be requested and positioned at Staging to support frequent rotation and adequate rehabilitation and hydration. Consideration should be given to rotating crews to support functions such as Staging or Base after having been involved in direct firefighting for a prolonged period. A significant high-rise fire is a huge logistical undertaking and therefore ample opportunity to rotate personnel into non-firefighting support tasks should exist.

Deploying 1 3/4" Hose Packs



Prepare to deploy hose pack on the landing below the fire floor



Open the standpipe valve to flush any debris and check for water flow



Attach the in-line pressure gauge, gated wye, and hosepack A to the standpipe outlet, one floor below the fire floor, spanner tight



Spread open the hose pack, but do not flake out hose until charged.



Charge hoseline and adjust PRV as necessary based upon the pressure reading from the in-line pressure gauge with water flowing.



Advance the charged hose line to the fire floor.



Building a 2 1/2" Hose Pack - Shoulder Load Method



Remove any nozzles or gated wyes and shoulder load 50' of 2 1/2" Hose



Break the coupling and have a partner duct tape the hose together



Once duct taped on both ends, secure a smooth bore nozzle with a shut off butt

Building a 2 1/2" Hose Pack - Ground Method



Remove any nozzles or gated wyes and lay out 50' of 2 1/2" hose on the ground



Continue to pull out hose as you make folds approximately every 6' to 8'



Break the hose and duct tape the bundle together on both ends

Deploying 2 1/2" Hose Packs



Ascend to the fire floor with the pre-made 2 1/2" hose packs



Lay out the hose packs on the fire floor landing aligning the couplings & attach nozzle



Connect hose packs & remove tape

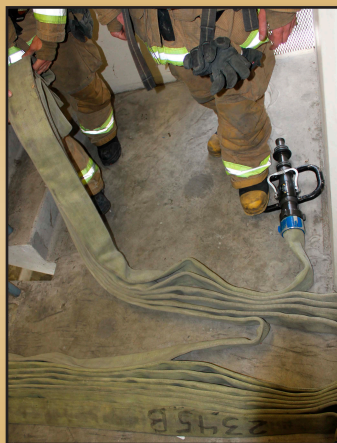

Leaving the nozzle in place, flake the first 50' to 75' of hose up the stairwell above the fire floor if conditions permit

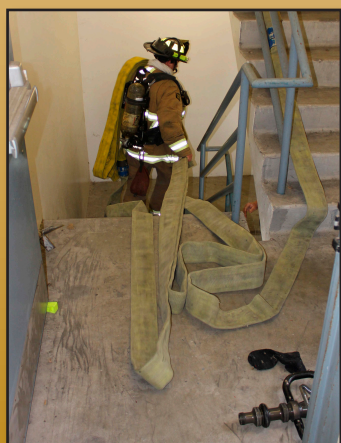

Take remaining hose downstairs one floor



Connect to the standpipe one floor below the fire floor and flake the remaining hose down that floor's hallway



Lobby Control

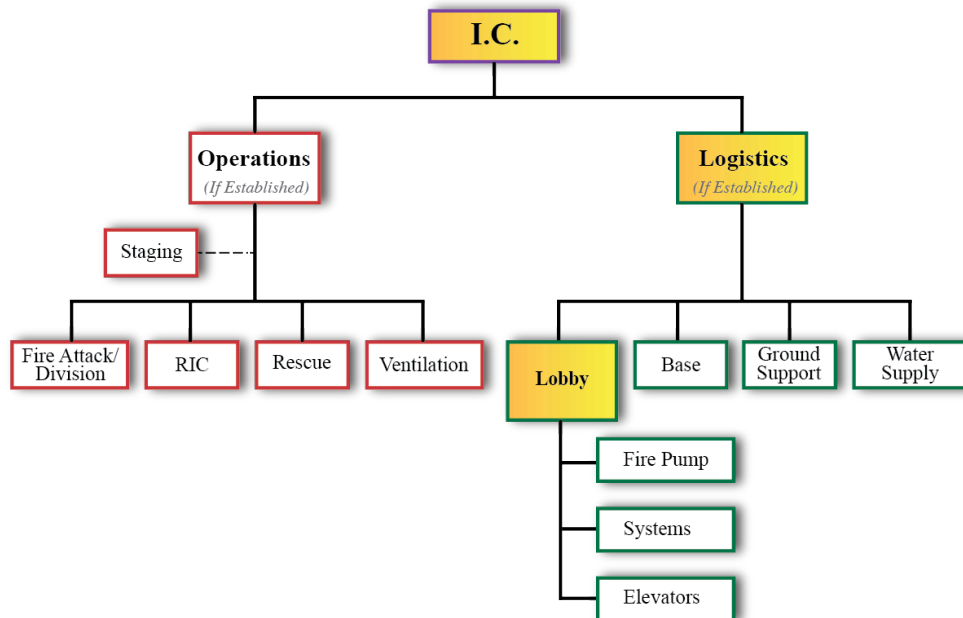

Primary Responsibilities

- Control all entrance & exit points
- Establish accountability system
- Direct crews to appropriate stairwell/elevator
- Direct fleeing occupants to safe egress
- Establish systems control
- Recall/account for elevators & assign operators

Generally speaking Lobby Control is tasked with giving organization to a high-rise fire. Tasks include controlling entry and exit to the building, personnel accountability, elevator accountability and operation, and systems control, [Figure 31-22](#). Initially, the third engine company to arrive shall be assigned Lobby. However, additional companies will be required to successfully carry out the multitude of tasks required of Lobby Control; therefore in the initial phases of an incident the initial crew assigned to Lobby Control should expect to be challenged. Having an organized Lobby will transcend all aspects of the fire and have a significant impact on the success of the operation. .



Figure 31-22 Lobby Control is tasked with controlling all entry and exit points

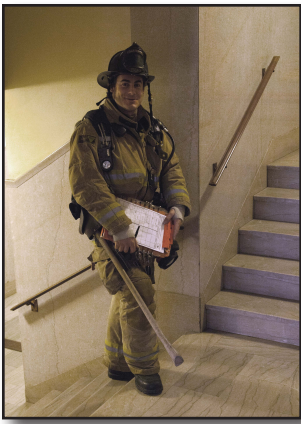

Figure 31-23 Lobby Control must set up accountability for crews entering the building.

Control All Entry and Exit Points

Lobby Control will need to ascertain the safest entry and exit points to the building., Factors such as falling glass should be considered. Utilization of banner tape and signage may be helpful in directing people and firefighters. Creating choke points rather than having multiple access points will facilitate accountability. San Diego Police may be used to control these access points.

Establish Accountability System

Utilize standard procedures for accountability. After establishing Lobby Control ensure the orange Accountability Board left by initial ascending crews is located and those crews are accounted for. All crews entering/leaving the building shall be accounted for by Lobby Control. This accountability officer should not be confused with the accountability officer that is required at Staging; these are two separate but required positions. The lobby accountability officer collects only the crew accountability tags carried by the Captains, not the individual tags carried by all firefighters, [Figure 31-23](#).

Elevator Control

Lobby Control should recall and account for all elevators. This can be done from the Fire Control Room or by utilizing an elevator fire service key in the elevator lobby and placing the elevators in Phase I recall mode, [Figure 31-24](#). Remember to account for every elevator including freight elevators and elevators in the parking garage. If an elevator cannot be accounted for it must be searched., Report this to the IC. Elevators may be in use by ascending fire attack crews upon your arrival., These cars will not recall because they will be in Phase II operations.

A very important point to remember here is if the elevators have automatically been recalled prior to FD arrival, the elevators are telling you something is wrong with them. Do not use elevators for initial attack if automatic recall has occurred, because this this indicates a smoke or heat detector has activated in an elevator lobby, machine room or hoist-way.

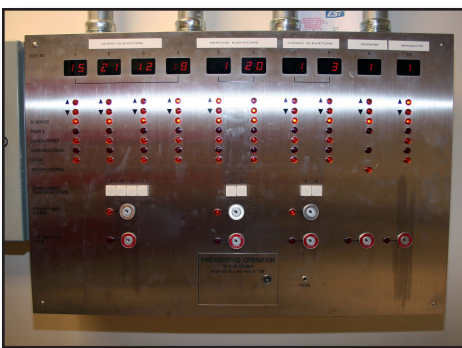

Figure 31-24 Elevators can be put into phase I recall from the lobby (top) or from the elevator control panel in the fire control room (bottom)

Unlock Stairwell Doors/Obtain Keys

Modern life-safety buildings incorporate a feature that automatically unlocks doors in the stairwell/path of egress upon alarm activation. This feature could have prevented the deaths in the Cook County Administration Building fire in 2003 as those victims could not re-enter a floor once in the stairwell because the doors locked behind them. The control for this feature will likely be on the alarm panel or smoke management panel and typically has a manual override/activation position with an indicator light. If auto-stairwell unlock is not working or the building is not equipped with this feature it is imperative that keys be obtained



and issued to ascending crews. Fire Attack should ensure the auto-unlock has occurred or obtain stairwell keys prior to their ascent.

Direct Crews To Appropriate Stairwell/Elevator

Fire Attack will have identified a stairwell for attack and the stairwells for evacuation. If the stairwells are being utilized for ascent, be sure to direct incoming firefighters to the appropriate stairwell. Label each stairwell with highly visible signage.

If elevators are being utilized for ascent Lobby Control will assign dedicated elevator operators. During the initial phases of the incident manpower may not allow for Lobby Control to assign this function. Therefore ensure ascending firefighters are reminded to return the elevator car so others can use it. Always follow the elevator checklist, without exception.

Systems Control

This position may be quite elementary in an older high-rise with limited built-in fire and life safety systems or could appear more daunting in a modern life-safety high-rise. Modern buildings have the advantage of automation. Many of the critical initial actions required of alarm systems, stairwell unlocking, public address systems, fire pumps, and smoke handling systems will be done automatically. Therefore it's important to have thorough pre-plans and meet with a building engineer as soon as possible after arrival to effectively evaluate the presence and effectiveness of various systems.

Systems Control will be responsible for monitoring and operating systems such as smoke handling, fire pumps, public address system, fire department communications (red phone), generator, and elevator recall, [Figure 31-25](#). This position may require more than one individual and become its own group in particularly complex incidents, which will be designated Systems Control Group and will report to Logistics. Refer to the Systems Control section of this chapter for greater detail.

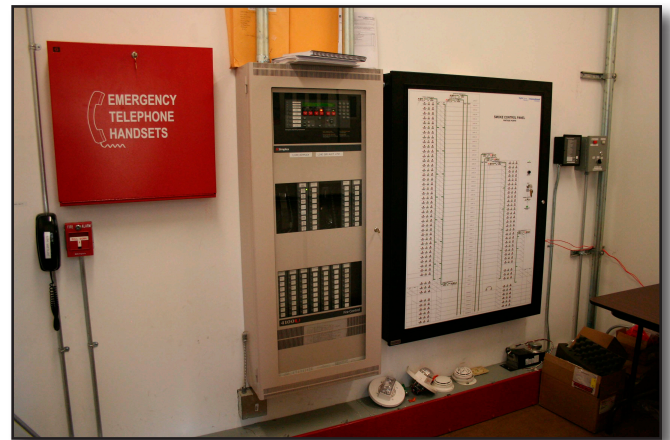
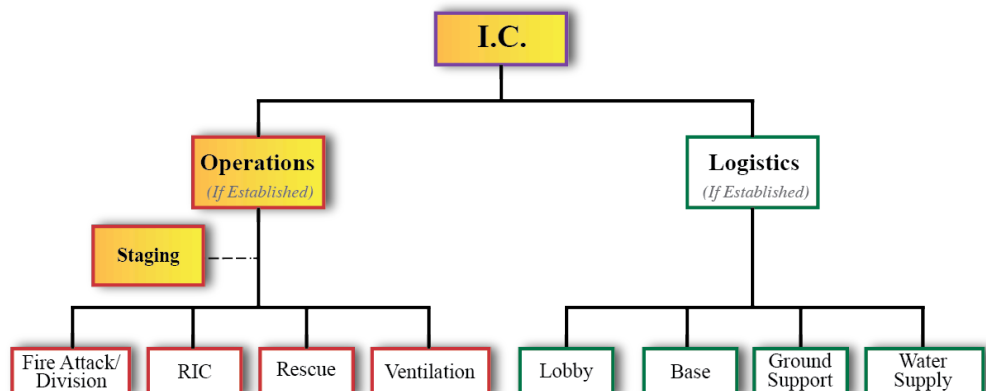

Figure 31-25 The Fire Control Room contains the alarm panel, elevator control panel, emergency communication system, smoke control system among other vital information and equipment.



Staging



Primary Responsibilities

- Select suitable area for staging
- Establish accountability system
- Bring RIC bag / Augment I-RIC
- Develop an equipment cache

Staging can be considered a forward operating base, directly supporting the firefighting operation by maintaining a reserve of personnel and equipment for rotation into the fire. Additionally, Staging provides an area for firefighters to rotate out to take a break. Hydration, food and medical attention should be available. Crews assigned Staging should take banner tape, writing paper, pens, pencils and duct tape to facilitate organization. Lastly, Staging is responsible for bringing the RIC bag aloft as they will be augmenting I-RIC until enough resources arrive to establish a dedicated RIC Group.

Accountability

Fire Attack will have left the orange Accountability Board with crew member individual tags in an obvious place at a level they thought would be suitable for Staging (2-3 floors below fire floor) prior to deploying their lines and attacking the fire. Staging will set up an accountability system consistent with SDFD Standard Operating Procedures. Ensure that ascending crews do not bypass Staging. This can be done with signage and banner tape, or if required, by placing a firefighter in the stairwell to direct crews. By stopping at Staging crews can check in for accountability purposes and to receive their assignment. This may require them to fall into the rotation and stand-by for a moment until directed to relieve crews assigned to Fire Attack.



Location and Facilities

The Staging Manager shall ensure that the initial site selection is appropriate. Remember, Fire Attack only took a cursory look around. Considerations when choosing a site for Staging:

- Large enough to accommodate the incident as it grows
- Free from smoke
- Good lighting
- Restrooms

The Staging Manager shall also designate distinct areas within Staging with banner tape and signage for things such as:

- Rest and Rehab with plenty of drinking water and snacks
- Crews ready to deploy
- Full and empty SCBA bottles
- Equipment ready to deploy
- Equipment in need of repair/maintenance
- Medical area

Staging Equipment Cache

Staging should build a cache of gear and request vital supplies. Seek input from the Division leading the fire attack to determine needs. Remember reflex time when requesting equipment and supplies. Good documentation is essential to track the movement of equipment, supplies and personnel into and out of Staging. In addition to the needs of the Division, consider the following supplies and equipment:

- SCBA bottles and drinking water are a very high priority early on
- Hose, nozzles, and fittings
- Gas detectors
- Pike poles, rescue saws
- Salvage equipment
- Blowers
- Lighting/generator
- Snacks

A good Staging Manager should plan for the worst. Ensure an area is dedicated for medical care. Anticipate the likelihood of a total power failure. Have a lighting plan in place prior to the loss of power. Also, continuously monitor air quality in the staging area.



Rapid Intervention Crew Functions (RIC)

Fire Attack will have established I-RIC prior to attacking the fire. Staging personnel will augment the I-RIC members to ensure adequate capabilities. As more resources arrive a dedicated RIC Group will be established and the Staging personnel will be relieved of this function.



Rescue Group

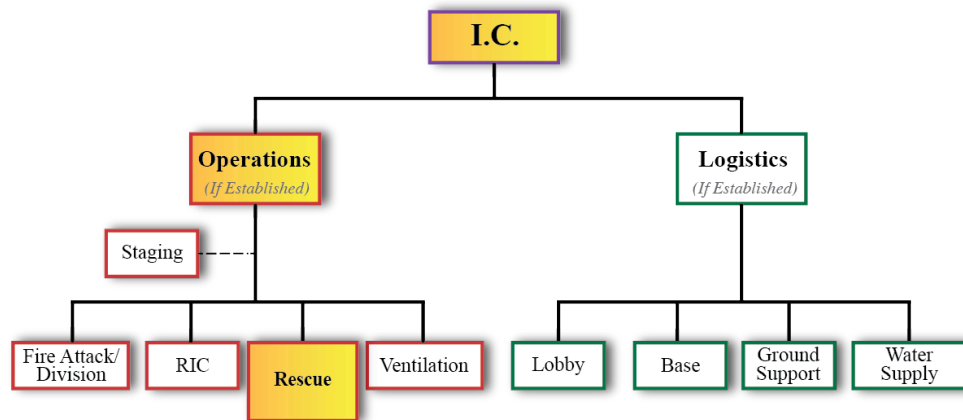

Primary Responsibilities

- #1 Priority is a rapid search of the attack stairwell above the fire floor
- Consider occupancy type, size of fire and time of day when developing search priorities
- Utilize “Rapid Ascent Tactics” to assist fleeing occupants to evacuation stairwell or safe refuge
- Continually roam stairwells

In a high-rise fire, like any other fire, we utilize the RECEO VS acronym to set fire ground priorities. However, the unique nature of a high-rise will require firefighters to incorporate some additional tactics into their standard repertoire.

In 2003 the Chicago Fire Department was found at fault in the deaths of 6 civilians at the Cook County Administration Building fire because firefighters opened a stairwell door on the 12th floor for fire attack prior to searching the stairwell above their position. Unfortunately, between the 16th and 22nd floors were civilians locked in the stairwell who died because locked stairwell doors made it impossible for them to escape back to the relative safety of the floor. The cause of death was CO poisoning. Other notable examples of the dangers of CO include the MGM Grand in 1980 and an NYC residential high-rise in 1998.





The Rescue Group is responsible for search and rescue. Civilians on the fire floor and floor above in immediate peril have the highest priority. However, absent reports of trapped occupants, we must consider the unique nature of a high-rise and the fact that we will be attacking the fire from an un-protected vertical shaft, essentially a chimney we call a stairwell. With that in mind, at high-rise fires searching the stairwells above the fire floor is critical; most importantly the attack stairwell. Conducting a stairwell search above the fire floor prior to or while simultaneously advancing on to the fire floor will help to prevent another Cook County Administration Building incident. Once a stairwell is being used for fire attack it cannot be used for evacuation.



Figure 31-26 Rapid Ascent Tactics

Rapid Ascent Tactics

The Chicago FD in response to the scathing report of their failed tactics at the Cook County Administration Building developed Rapid Ascent Tactics (RAT). Rapid Ascent Tactics emphasize the importance of searching the stairwells above the fire floor with the greatest priority on the Attack Stairwell prior to or during fire attack, [Figure 31-26](#). This also includes continually monitoring the stairwells throughout the event, sparing potential victims from deadly CO exposure. Crews in stairwells will typically not be making “hands on rescues,” rather they will be giving direction to fleeing occupants, directing them to the evacuation stairwell or safe refuge areas. Once stairwell searches are complete or underway, additional search priorities will be addressed.

In 2004 a fire occurred in the La Salle Bank Building in Chicago. The fire was on the 29th floor and was after normal working hours. There were 500 people in the building. Chicago FD assigned Rescue Groups to the Attack Stairwell who utilized Rapid Ascent Tactics. These crews rapidly searched above the fire floor in the Attack Stairwell prior to opening the door on the fire floor to advance their line. Additionally they continuously roamed the attack and evacuation stairwells throughout the event keeping civilians out of the Attack Stairwell and directing them to the evacuation stairwell.

As a result, there were no fatalities. This fire validated the importance of keeping evacuees out of the Attack Stairwell and demonstrated the benefit of Rapid Ascent Tactics. The Chicago Fire Department received tremendous praise for the implementation of these newly developed tactics and the success of this fire.

Based on the success of the Chicago Fire Department, SDFD now incorporates Rapid Ascent Tactics into the Rescue Group. Upon initial arrival at a high-rise fire the Incident Commander will consider several factors when determining



tactical priorities and number of resources to dedicate to the Rescue Group. These factors include:

- Occupancy type (residential, commercial, hospital, correctional facility etc.)
- Time of day
- Size of fire
- Reports of trapped victims

Search Priorities

Fire Attack, as previously outlined, will determine the risk/benefit of attacking the fire or briefly compartmentalizing the fire until a stairwell search is complete or underway. Generally speaking, absent reports of occupants trapped on the fire floor or in immediate peril, the search priorities are:

- Stairwells
- #1 Attack Stairwell above fire floor
- #2 Evacuation Stairwells above the fire floor
- Fire floor and the 3 floors above the fire floor
- Top 3 floors
- 3 Floors below the fire floor
- Stuck elevators
- Continual roaming of stairwells

Ultimately the entire building will require a search because of the insidious movement of fire gases unless the fire is very small and the products of combustion are limited.

High-Rise Search Procedures

The Rescue Group shall determine the lowest level (floor) that is alarming and ensure that all the stairwell doors leading to the floors are unlocked or keys are obtained. This is important because it allows occupants evacuating the structure in a smoky stairwell to exit to the relative safety of a floor. The Rescue Group must also determine which stairwell is designated for attack and which are designated for evacuation of residents.

Search Group Equipment

Firefighters assigned to the Rescue Group should travel light and not bring unnecessary equipment with them. Speed is essential for stairwell and floor searches. Ideally the elevators will be used if it is safe to do so. Otherwise



crews must utilize the stairwell. The following equipment should be carried with you and your crew if you are assigned to the Rescue Group:

- Full PPE & Radios
- High-Rise Escape pack
- Forcible entry tools / rescue saw / keys
- TIC
- One spare bottle per person
- Red phone
- Duct tape

During the search give updates on conditions in the stairwell as well as on floors. This will be beneficial to the IC, the Ventilation Group and Systems Control as they will be able to gauge the effectiveness of the pressurization systems and smoke management systems. These updates will also help to shape a strategy for occupant protective actions that will likely require a mix of evacuation, relocation to safe refuge areas, and shelter-in-place tactics.



Figure 31-27 Evacuating occupants may overwhelm the stairway for firefighters ascending (WTC 9/11/2001)

Evacuation vs. Shelter in Place

Total evacuation is the least desirable action to take. However, in light of the collapses at the World Trade Center, many people may disregard messages to shelter-in-place and attempt to evacuate the building, further complicating matters

Remember that “hands-on” rescues in stairwells will not be the norm for the Rescue Group. Evacuees in the stairwell will typically be mobile and only require direction. If necessary consider enlisting the help of able bodied evacuees to assist slower individuals to the evacuation stairwell or safe refuge.

Be prepared to open the roof top door as directed. Indiscriminate opening of the roof top access may cause extreme fire behavior. Remember that pressurization rather than ventilation is the initial objective. Operating from an area of high pressure affords us a margin of safety.

Once stairwells have been searched and firefighters begin to search the floors, standard search techniques shall be employed. The type of structure will dictate the tactics; a large commercial high-rise with a sea of cubicles will require a different plan than a residential high-rise. Using search ropes and the TIC will enhance effectiveness and crew safety. See the Search & Rescue chapter for more detail on this subject.



Ventilation Group

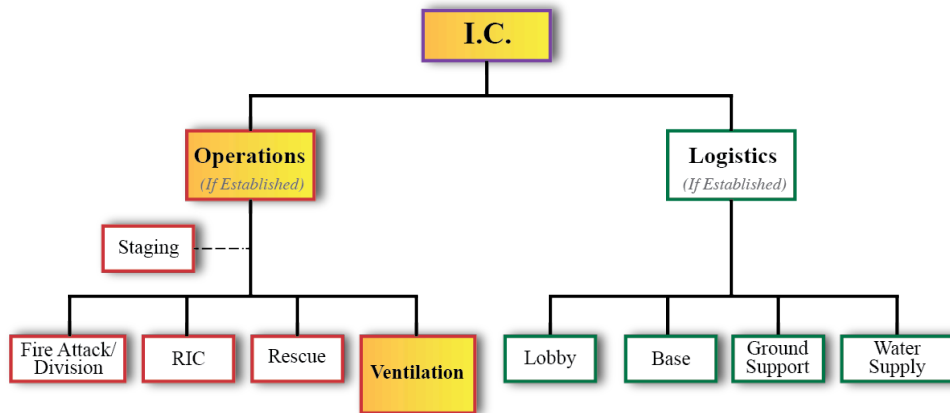

Primary Responsibilities

- Consider era of construction and determine presence of smoke handling systems
- If no dedicated smoke handling system, consider shut-down of HVAC
- Assess stairwell pressurization
- Coordinate with attack and rescue crews to determine effectiveness of pressurization and smoke handling systems

The Ventilation Group plays a vital role in the success of any high-rise fire operation. The modern energy efficient sealed commercial high-rise presents a significant challenge when attempting to ventilate the products of combustion. This results in potentially punishing conditions for firefighters. In an un-compartmentalized commercial high-rise fire, one should expect to find high temperatures and low visibility. Residential high-rises may present less challenge due to inherent compartmentalization and openings to the outside.

Pressurization

The term Ventilation Group omits a key objective that is of equal importance to ventilation; pressurization. Pressurization limits the spread of fire and smoke. Fire would prefer to take the path of least resistance and travel from its location (high pressure) to an area of low pressure. This of course could be problematic if firefighters open a stairwell rooftop access door at the same time firefighters are entering the fire floor. The result would be fire pulled toward the firefighters in its attempt to seek that area of low pressure created by the rooftop opening.

Another low pressure scenario could play out if windows are opened inappro-



priately in an area removed from the fire; high pressure seeks out low pressure and the fire will be drawn to the opening. By maintaining or creating positive pressure gradients, we can limit the spread of smoke and fire as well as keep the stairwells and egress paths clear for escaping occupants.

Additionally firefighters will benefit by having a pressurized attack stairwell. It allows them to operate from an area of higher pressure which will work to push the fire away as they advance. This higher pressure also provides an area of relatively safe refuge in the event of a hasty retreat.

Once the scope of the fire is determined and the attack is underway, attention can be turned to ventilation. When ventilating, areas of low pressure are created to draw the heat and smoke out of the floors, stairwells and building. These actions shall always be done in coordination with attack crews and thought will be given to the path of travel of superheated gases and smoke, as well as the potential life safety and exposure problems created by this action.

High-Rise Ventilation Fundamentals

Prior to discussing pressurization and ventilation any further it's important to review the fundamentals of air movement in high-rise buildings as these phenomena will enhance your understanding of the unique features of a high-rise.

Stack Effect

Stack Effect is created by temperature differences between the inside of the building and the outside ambient temperature. This effect is more pronounced in regions with greater environmental extremes. If the outside temperature is quite cool compared to the inside, air will naturally be drawn in at the bottom floors. Because warm air rises, it will exit the building at the upper levels, creating a positive stack effect, [Figure 31-28](#).

If the temperature is hot outside and cooler inside, the air will be drawn in at the top floors. Because cold air sinks, the air will exit the building at the bottom floors creating a reverse or negative stack effect, [Figure 31-29](#). Factors that will affect the magnitude of the stack effect include:

- Temperatures differences between inside and outside
- Height of building
- Building leakage (the more tightly a building is sealed up the more pronounced the effect)

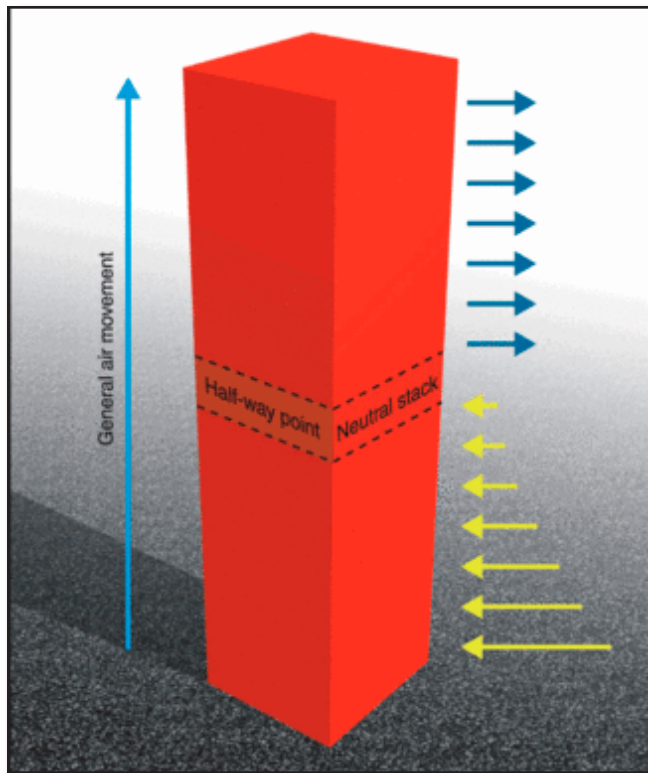

Figure 31-28 Positive Stack Effect - Occurs when the outside air is cooler than the air inside the building, causing air to rise inside the building.

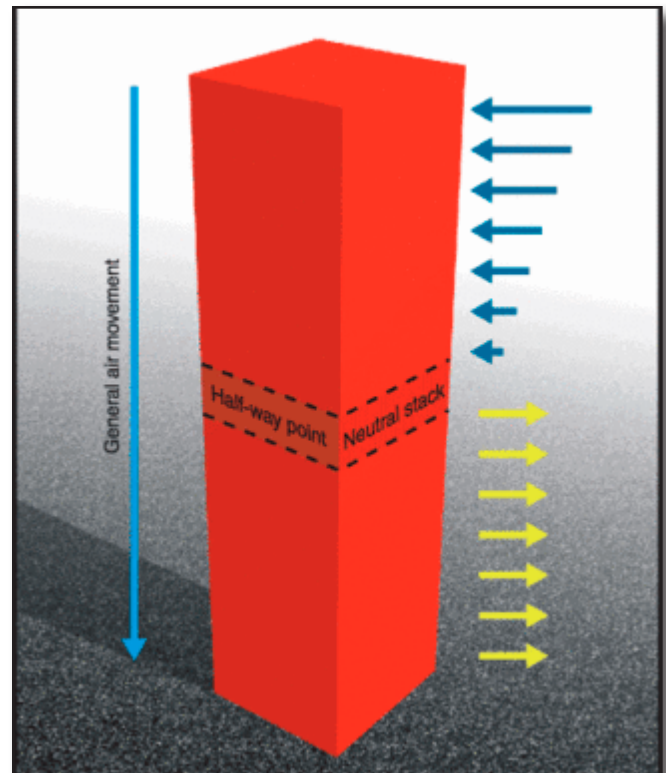

Figure 31-29 Reverse/Negative Stack Effect - Occurs when the outside air is warmer than the air inside the building, causing air to sink inside the building.

Neutral Pressure Plane:

The neutral pressure plane relates to stack effect. It is the point at which there is equilibrium in barometric pressure between the inside and outside of a building resulting in no active air movement. This neutral plane may extend several floors; the airflow is reversed on either side of the neutral pressure plane.

Predictable natural air movement in the building will affect the movement of smoke and fire gases. Additionally, when determining the effectiveness of ventilation activities be sure to consider the stack effect and neutral pressure plane. It may cause a change in tactics from vertical to horizontal ventilation especially if dealing with cold smoke and a reverse stack effect. Methods to evaluate stack effect and neutral pressure plane include:

- Open a window to the outside and determine direction of air flow
- Open doors at lobby level and determine if air is being drawn in (positive stack effect) or exiting the building (reverse/negative stack effect).

Stratification of Smoke

The taller the building and the colder the smoke, the more likely stratification will occur as buoyancy is lost. This is a very dangerous situation as CO can be present in deadly concentrations. Crews encountering stratification should no-

tify their supervisor to get this information back to Operations in order to make tactical adjustments to search priorities.

Mushrooming of smoke

Mushrooming of smoke is the same phenomenon that we routinely encounter at residential fires, but on a grander scale. Because smoke may travel to the top floors of a structure and pose a significant life-safety threat, a search of the top 3 floors should receive a high tactical priority.

Wind

Wind can create extreme fire behavior for obvious reasons and firefighters should expect strong and erratic winds at high-rise incidents. Despite operating in a sealed commercial high-rise with no openings, windows fail under fire conditions. Depending on the exposure of the opening to wind, fire behavior may dramatically increase. Likewise, in a residential building inadvertent opening of windows by firefighter, civilians, or failure due to fire may turn a simple mattress fire into a roaring inferno. This is especially true in corner units where wind can channel through the unit having access to the windward and leeward sides, [Figure 31-31](#).

FDNY, the preeminent authority on high-rise firefighting, has suffered several fatalities due to dramatic increases in fire behavior caused by the unexpected introduction of wind. This has prompted the development of wind-driven firefighting strategies and tactics based on extensive research and testing. These include the use of a fire blanket that's dropped from a high point to the involved floor, covering the opening effectively negating the effect of the wind.

Also, the use of a nozzle that's bent in a manner that allows firefighters to direct water into the window from the floor below. Once the heat is taken out of the fire with the nozzle from below, the firefighters can stretch a hand-line on to the floor and perform final extinguishment. Although this technology is currently unavailable to us, it is important that all firefighters understand that winds aloft can be very different than the winds at ground level and fire behavior can be dramatically affected by this variable.

High-Rise Smoke Handling Systems

Consider the era of construction and presence of dedicated smoke handling systems. This is important because it will dictate your actions later. Modern life-safety high-rise buildings have dedicated smoke handling systems that are

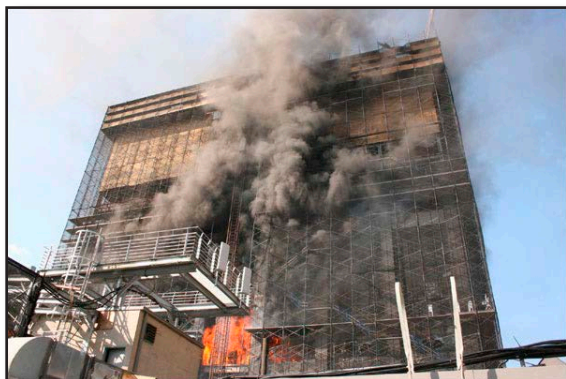

Figure 31-30 Heavy smoke conditions - Deutsche Bank Fire 2007 - 2 FDNY Firefighters killed due to smoke and CO inhalation

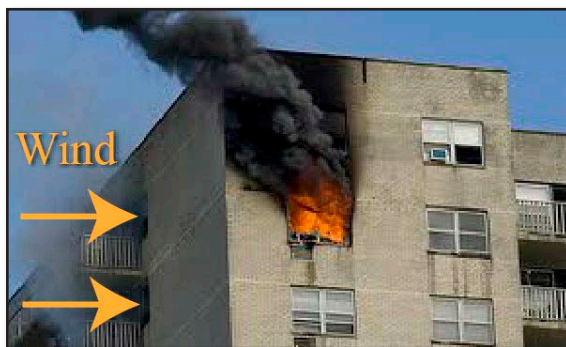

Figure 31-31 Fires in high-rises can be intensified by wind causing extreme fire behavior



highly effective. These systems automatically activate upon alarm while the HVAC system simultaneously shuts down. Generally speaking, these modern dedicated smoke handling systems are of great benefit and should be left alone, at least during the initial phase of the incident.

Life Safety Commercial High-Rise Buildings

In a life safety commercial building the fire floor will go into exhaust mode (supply shuts down) and the floors above and below the alarm floor will go into pressurization mode (exhaust shuts down) and the HVAC system will shut down. This works to rid the fire floor of smoke which will exhaust out the sides of the building or the roof. Therefore visible smoke may be coming from the building from an area far removed from the actual fire location as part of normal alarm mode. The pressurized floors above and below the alarm floor will effectively sandwich the fire and prevent its spread. The stairwells and elevator shafts will also pressurize, [Figure 31-32](#).



[Figure 31-32](#) Stairwell pressurization vent

Life Safety Residential High-Rise Buildings

In a life safety residential building, the building is highly compartmentalized and each unit has its own environmental control system. Therefore, when the building is in alarm mode, whole floors will not likely pressurize. Rather stairwells, elevator shafts and common egress paths will likely be the areas pressurized to facilitate evacuation of occupants and prevention of fire spread.

The importance of pre-planning cannot be over-emphasized as each building has unique characteristics. Without familiarity of these buildings, the systems may seem daunting, [Figure 31-33](#). It's important to remember that life safety buildings equipped with dedicated smoke handling systems are likely very beneficial when left to their own devices, especially during the initial phases of an incident.

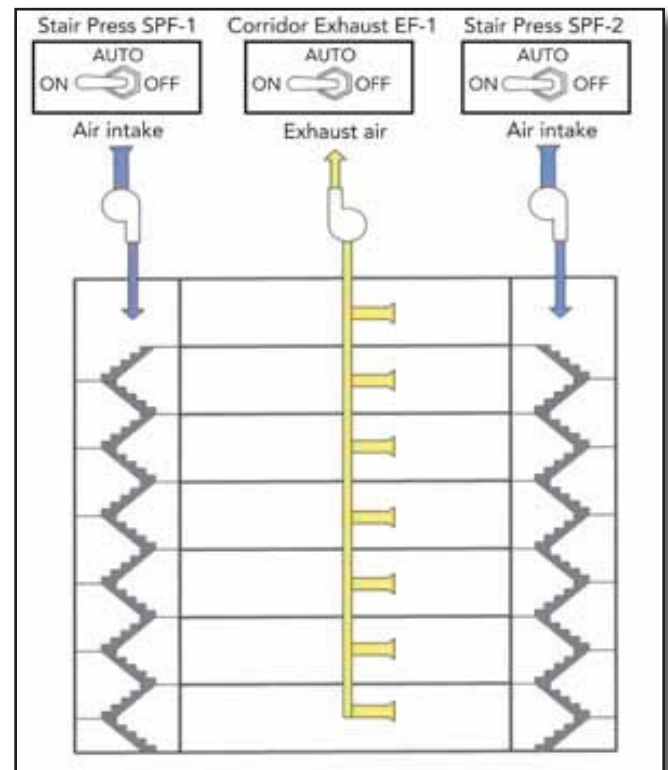

[Figure 31-33](#) Diagram of a Smoke Control/Handling Panel

Existing High-Rise Buildings

High-rises built before the mid 1970's will not likely have dedicated smoke handling systems and may instead be equipped with smoke towers. Consider shutting down the HVAC system on arrival. Remember the commercial wide open floor plan high-rise is the main concern. Residential high-rises regardless of the era offer greater protection due to compartmentalization.



High-Rise HVAC Systems

Commercial high-rise HVAC systems typically have two principle air supplies. One feeds from the core through ducting to serve the main floor area, the second feeds from the periphery of the building and serves the area in proximity to the exterior wall. The return air is generally collected through openings in the ceiling plenum from which it flows to a return shaft under a slight negative pressure.

If HVAC systems are left on during the initial stages of a fire, they may increase the intensity of the fire and contribute to its spread. However, once hose-lines are in place and a person with knowledge of the system is available the system may be selectively activated to improve the environment for firefighters.

An example would be if firefighters were attacking the fire, advancing from the core toward the periphery. It may be advantageous to shut down the supply to the periphery and restore the supply to the core. This would then create an air flow pattern that would facilitate the advancement of hose-lines. This may or may not be possible based on the way the system was engineered. Some systems may not lend themselves to creating an effective pressure differential.

Consideration should always be given to the path the smoke and superheated gases travel and the potential exposure problems they present. Having technical experts who fully understand a building's HVAC system is indispensable when considering restoring portions of the system.. Remember, early shut down may limit fire spread and will likely be the most prudent initial action taken by firefighters.

Ventilation Group Tactics

Control and pressurization of the stairwells is paramount for both firefighters and civilians. Assessing stairwell pressurization will of course require an evaluation of fixed systems. This information can be gathered by communicating with operating crews who can give condition updates about the stairwells and floors.

Remember the fixed systems were engineered to effectively pressurize the stairwell with a certain number of stairwell doors open while maintaining an effective pressure gradient; if the number of doors exceeds the engineered specifications stairwell contamination will occur. This is why it's important to avoid propping open stairwell doors. If doors will not stay unlocked, use duct-tape to prevent the door from locking but still allow it to close, [Figure 31-34](#). Early augmentation with blowers may prove beneficial and should be considered.

Mechanical Ventilation (Blowers)

Rescue Group will be engaged in a search of the stairwells above the fire floor and will likely be a source of good information. Based on this reconnaissance or in the absence of good information, the Ventilation Group may implement



Figure 31-34 Duct tape placed over the door latch allows the door to close for stairwell pressurization but not lock you out



pressurization if fixed systems are absent or deemed ineffective, by placing blowers at the ground floor, every 10 floors and 2 floors below the involved floor(s).

Blower Key Points

- Blowers should not be placed in the stairwell due to CO accumulation. Additionally, noise and stairwell congestion will prove problematic.
- Fans should be placed 4-6' back from door openings if using 2 fans to form a converging V pattern.
- Blowers should be placed on the ground floor, every 10 floors and 2 floors below involved floor(s).
- A firefighter should always remain in close proximity to running blowers in case immediate shutdown is required.
- Monitor CO levels in stairwells and in areas where blowers are being operated.

Ventilation Strategy

Attempts to ventilate should only be undertaken once the fire has been located and hose-lines are in place. This endeavor should be closely coordinated with attack crews. Remember, fire will seek out areas of low pressure and therefore careful consideration must be given to where the heat and smoke will travel once positive or negative pressurization begins. Firefighters have died when fire has been drawn toward them as it seeks an area of low pressure.

Vertical Ventilation

Vertical ventilation should be done through a stairwell that has roof access, [Figure 31-35](#). This would ideally be the stairwell selected for Fire Attack. The evacuation stairwell shall never be utilized for ventilation. Vertical ventilation may be the tactic utilized in a sealed high-rise; however, consideration should be given to the reverse stack effect on extremely hot days as well as stratification when dealing with cold smoke.

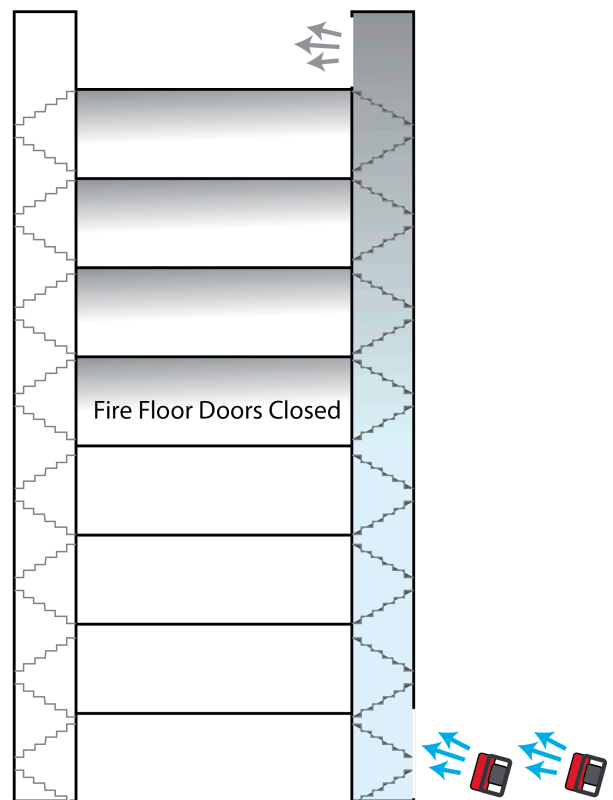

Figure 31-35 Vertical Ventilation of Stairwell



Horizontal Ventilation

If the reverse stack effect or stratification make vertical ventilation a non-viable option, or in the case of residential high-rises that have numerous openings to the outside, horizontal ventilation may be the best choice. Consider winds aloft when making a plan and ideally make openings on the leeward side. Consider going to an uninvolved floor and evaluating the wind.

If cross ventilating, always open the leeward side first and never break glass without IC permission. Always protect openings of broken windows so members don't fall out when moving in the smoky environment. Move furniture and place banner tape across the openings to help protect firefighters. Consider placing hose-lines above ventilation openings.

Operation of the air handling system will be required during ventilation operations as shutting down areas of pressurization will be required to facilitate air movement. Ideally this will be done with a knowledgeable person present such as the building engineer.

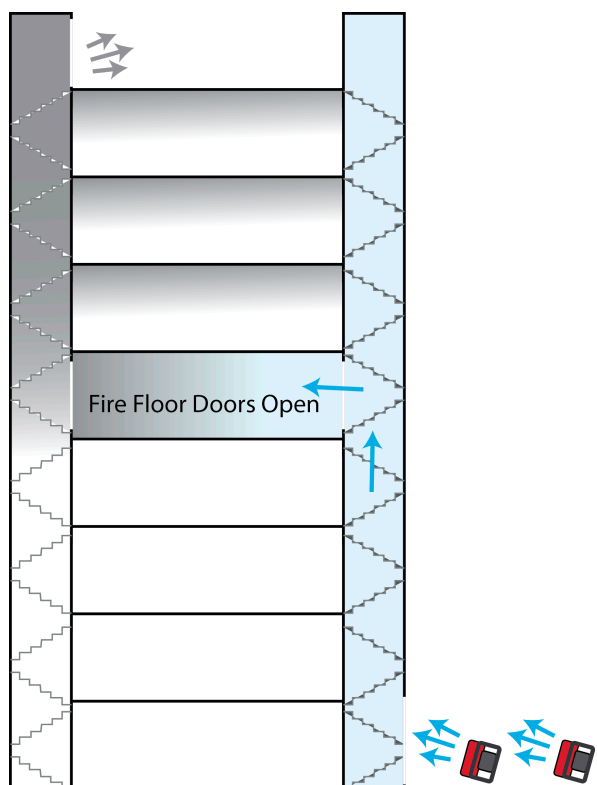

Figure 31-36 Horizontal / Cross Ventilation exhausting out opposite stairwell

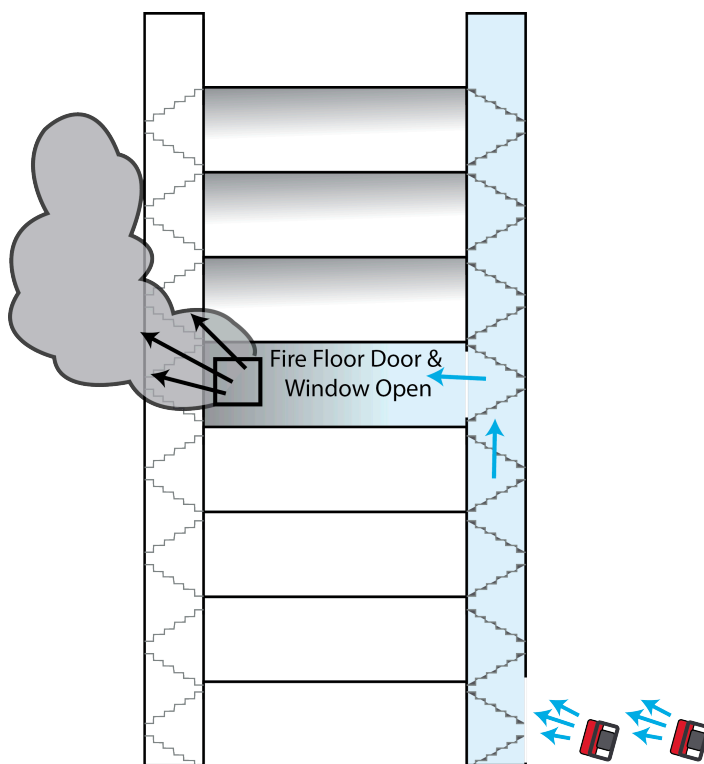
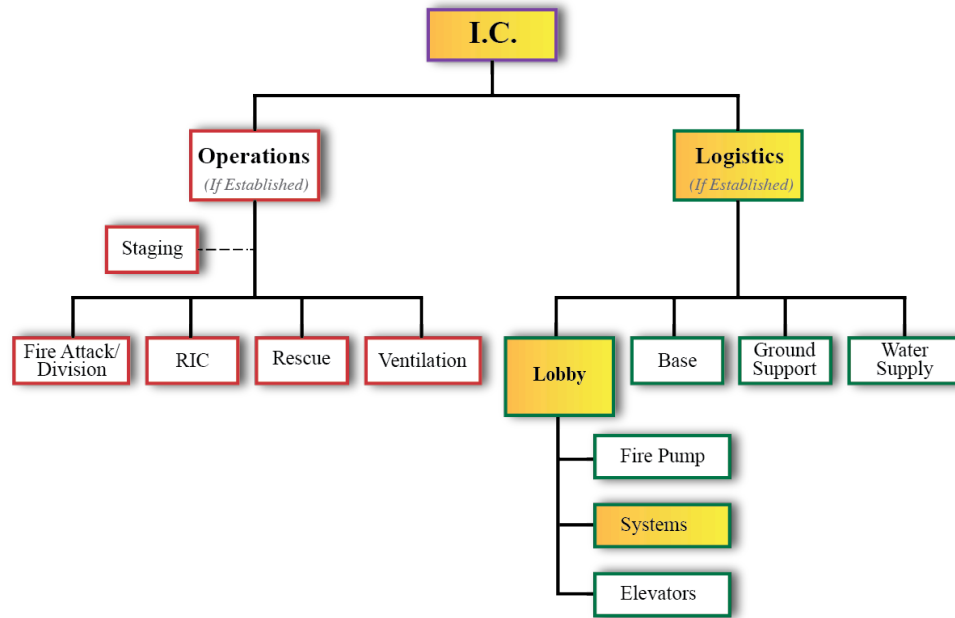

Figure 31-37 Horizontal / Cross Ventilation exhausting out open window on fire floor



Systems Control



Primary Responsibilities

- Request building engineer/technical experts
- Ensure stairwells auto-unlock and/or keys are issued
- Monitor & operate systems
 - Alarm panel
 - Fire pump
 - Power generation
 - Smoke handling systems/pressurization
 - Elevator recall & accountability
 - Public address system/communication system

Systems Control may initially appear to be quite complex. However, in a life-safety high-rise the systems generally operate automatically and are of great benefit to the firefighting operation. Examples of the types of automatic actions that take place when an alarm is initiated include:

- Announcement at fire control room and central monitoring for both alarm

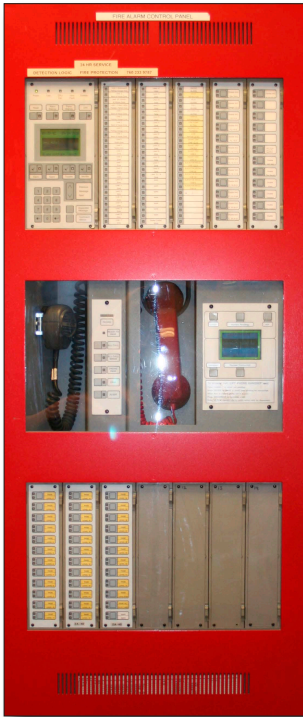

Figure 31-38 Fire Alarm / Annunciator Panel

- and trouble
- Activation of audible and visual alarms
- HVAC shut down (may be floor of alarm or a zone, designs vary)
- Smoke and fire dampers close on floor of alarm
- Activation of smoke evacuation system on floor of alarm
- Activation of stairwell pressurization
- Depending on system design pressurization systems on floors above and below level of alarm or other select areas may activate. .
- Release of stairwell door locking mechanisms and other designated security doors
- Closure of all magnetically held fire doors
- Recall of elevators if alarm is in elevator hoist-way, machine room, or elevator lobby

Because all fire control systems vary to some degree, the most effective way to educate yourself with the operation of fire control systems is through pre-planning. The pre-plan walk around would ideally include a meeting with knowledgeable building staff to discuss systems capabilities. These capabilities may be quite limited in an older existing high-rise or may fall on the other end of the spectrum with a fully appointed state of the art fire control room. In either case the systems have similarities from building to building. Through continued familiarization, an individual assigned to the systems control position should be able to operate effectively.

Systems Control Responsibilities

In the initial phases of a high-rise fire Systems Control is a function of Lobby Control. Obviously only one firefighter will initially fill this role due to the simple fact that Lobby Control has so many tasks to accomplish with only 4 individuals. As the incident grows in complexity Systems Control can be made its own group and report to Logistics or it can remain a function of Lobby Control.

Request Building Engineer

Immediately request a building engineer if available, [Figure 31-39](#). The knowledge these individuals have is highly variable. If responding to a university or hospital the building engineers will be highly trained and skilled individuals who can offer a wealth of information. On the other hand many buildings are staffed with an individual possessing minimal knowledge whose primary function is that of a security guard.



Figure 31-39 Utilize the building engineer to assist with operations

Unlock Stairwells & Hand Out Keys

Ensure stairwells have unlocked automatically (indicator light on graphic display panel may be present) or ensure keys are issued. This will greatly fa-



facilitate operations as ascending crews will not have to force a bunch of doors, wasting time and energy. Additionally, if the stairwells have been unlocked it will ensure evacuees in the stairwells won't be trapped and can get back on to a floor.

Monitor Systems

Alarm Panel

Upon arrival at the alarm panel, note the indicator lights, [Figure 31-38](#). We are concerned with alarm activations which may indicate a Fire Alarm Initiating Device (FAID) has been activated (pull station, detectors etc). Trouble alarms indicate the presence of a circuit break or ground within a system.

Supervisory alarms indicate a problem with the condition of the building's automatic sprinkler system or other critical life safety component. Take note of the number and types of alarms activated. Remember that fire attack will have already consulted this panel and will likely be on the way up or preparing to do so. Once the alarms have been noted you can silence the alarm system to reduce confusion; this will silence the audio but maintain the visual strobes. If additional alarms are initiated, the audio will re-activate and you should notify ascending crews of these changing conditions. Remember there will likely be a printer near the panel that will show a history of alarm system activity.

Recall and Account for all Elevators, Figure 31-40

If Fire Attack is ascending in an elevator it must be in Phase II operation and your attempt to recall it will have no effect. Otherwise any elevator that cannot be recalled and accounted for must be searched. This will be the responsibility of the Rescue Group.

Smoke Handling & Pressurization Systems

Systems Control must assess the presence and effectiveness of the smoke handling pressurization systems, [Figure 31-41](#). Consider the shut-down of HVAC systems in older buildings. Let modern life-safety systems operate unless an unusual circumstance is noted, at which time your intervention may be required. Observe the various indicators and controls. This familiarization will prove helpful as the incident progresses and the need for ventilation is required. This will be the time that system intervention will be required which will include shutting down certain areas of pressurization such as the stairwells to facilitate airflow and subsequent ventilation. Information from ascending crews will be helpful in determining the effectiveness of pressurization systems.

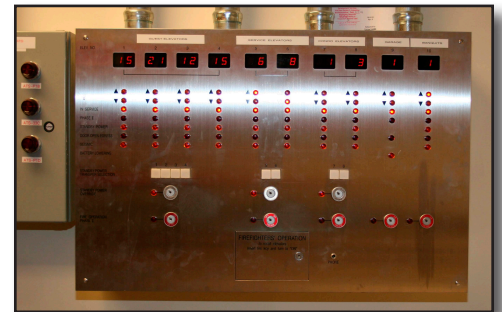

Figure 31-40 Elevator control panel located in Fire Control Room



Figure 31-41 Smoke Handling & Pressurization System Panel located in Fire Control Room



Figure 31-42 Building Fire Pump

Fire Pump

Communicate with the firefighter assigned to the fire pump room to ensure operations are normal and fuel level (if applicable) is being monitored, [Figure 31-42](#).



Figure 31-43 Power Generators may be found in certain modern high-rise buildings

Power Generation

Ensure a firefighter is sent to periodically check on generator status including fuel level, [Figure 31-43](#).

Ensure a dewatering plan is being developed in case the basement floods. Flooding in the basement can be problematic as the generator, fire pump and other vital systems are frequently located there. Do not use elevator shafts for dewatering; keeping the elevators in service is vital to incident success. Plus, water put in an elevator shaft will likely find its way to the basement. Use stairwells or openings in the building.

Public Address System

Recorded messages may be being delivered upon arrival. You can allow these to continue or you may choose to deliver messages via a microphone to selected areas or the entire building, [Figure 31-44](#). Total evacuation is the least desirable protective action. Ideally protective actions will be comprised of a mix of evacuation, shelter-in-place and relocation to safe refuge areas. Rescue Group will be giving continuous updates as they move throughout the building; these reports will be beneficial to developing an effective occupant protective actions strategy.



Figure 31-44 Public Address System (often incorporated into the alarm panel)

Interior Communication System (Red Phone)

The red phone (not always red) system is an interior phone communication system for firefighter use. A central switchboard is located in the fire control room and jacks as well as handsets are located throughout the building in places like the elevators, elevator lobbies, stairwells and fire pump room, [Figure 31-45](#). When a firefighter plugs in at a remote jack or picks up a handset, a flashing light goes off on the panel in the control room and a ring is heard. The control room operator then pushes a button next to the flashing light and talks to the firefighter. David Clark headsets will generally fit these jacks and may be beneficial in high noise areas.



Figure 31-45 Interior communication system (Red Phones)

Landline

Fire control rooms have dedicated landlines for fire operations needs.



Contingency Plan

Develop a contingency plan for catastrophic system failures. Anticipate problems and consult with SDGE, water department, and building engineers to plan for the unexpected. The First Interstate fire in Los Angeles and the One Meridian fire in Philadelphia both had power failures.

Although overwhelming at first glance, the Systems Control position should require little intervention, at least in the initial phase of a fire. As the incident progresses and resources become available, this position should ideally be staffed by a few firefighters to allow for division of labor to ensure adequate monitoring of the various systems. Consultation with knowledgeable personnel regarding the various systems is ideal.



Elevator Operations

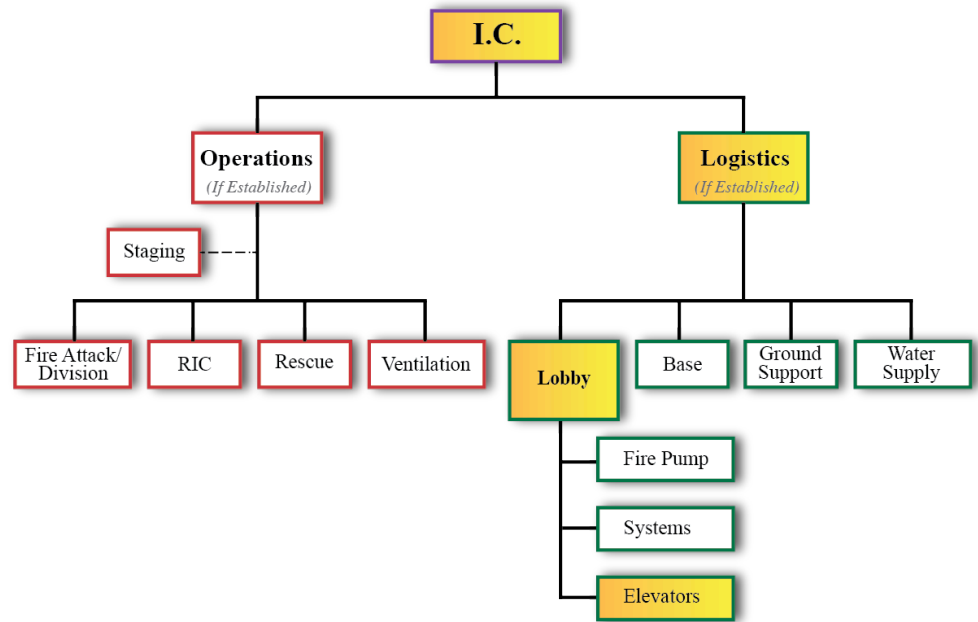

Primary Responsibilities

- Assess the elevators for the following:
 - Fire is above the 7th floor? Correct
 - Elevator is not in automatic Phase I recall on arrival? Correct
 - No smoke or water is in the hoistway? Correct
 - The elevator is Phase II equipped & the helmet is not flashing? Correct
- If all of the previous answers were correct, then take control of the elevators in Phase II

The advent of reliable and safe vertical transportation was a chief catalyst in the building of high-rise structures. However, many readers when they see the word elevator and high-rise fire automatically default to a “use the stairs” mindset out of fear of elevator malfunction. Elevators malfunctions and improper firefighter operation have caused firefighter and civilian deaths.

A classic example is a fire in Memphis Tennessee in April of 1994 that resulted in the death of two firefighters. The elevator used was not phase II equipped and the firefighters took the elevator to the floor of alarm. They had been in this building many times previously for false alarms and unattended food calls. However this time when the elevator doors opened, firefighters were met with a significant fire. There are many other reports of firefighter fatalities over the years caused by misuse and malfunction, however, over time the elevator industry has responded by engineering elevators with phase I and II operations



which result in elevators that can be utilized at a high-rise fire with an acceptable level of risk. The key to acceptable risk is a thorough understanding of basic elevator features, phase I and II operations, and adhering to Department SOP's.

The risk vs. benefit of using elevators rests in reflex time. Remember that fires under ideal conditions can double in size every 90 seconds. Couple this with having to climb 25 flights of stairs with a full complement of fire attack equipment and the equation for success seems less attractive. A recent study conducted by NIST demonstrated that it took firefighters 17-34 minutes to hike 38 floors vs. 2.5-3.5 minutes to get there by elevator. Crews that utilized the elevator were obviously less fatigued and could more effectively mount an aggressive attack. Based on this information it's clear that elevators are a necessary tool. Elevators do pose risk, however a significantly larger fire with a more fatigued crew who utilized the stairwell may pose an even greater risk.

Elevator Features

Firefighters shall only use elevators that incorporate the following safety features. Keep in mind that elevators from different eras of construction and retrofit complied with different rules and therefore subtle differences exist. However, the following features are commonly found in Phase I and II equipped elevators. An example of a variation would be destination elevators that lack a visible control panel. The panel does exist and does contain all the standard firefighter controls but it's hidden behind a concealed panel in the elevator car that's opened with the elevator control key.

Phase I Recall

This is a safety feature that causes the elevator to return to a designated level (most frequently the lobby) upon activation of a Fire Alarm Initiating Device (FAID) in an elevator lobby, hoist-way or machine room. Upon recall, an elevator in use will return to the pre-designated level and open its doors, [Figure 31-46](#). The car will remain there until it's put into Phase II mode or reset and put back into normal operation.

If the designated level is the source of the alarm an alternate designated level is programmed into the elevator. This is an important feature to note upon arrival. If the elevators are automatically recalled when you arrive it means something is wrong in the elevator system or elevator lobby. Do not use the elevators in this case for initial attack; they are unsafe until investigated further.

Elevators may also be recalled manually. This can be done from the main elevator lobby or fire control room. It's important that this gets done early on in an incident and is the responsibility of Lobby Control. All elevators must be accounted for to ensure no victims are trapped.

Phase II Firefighter Operation

This is something the firefighters at the tragedy in Memphis did not have. The problems they experienced may likely have been averted had the car they were

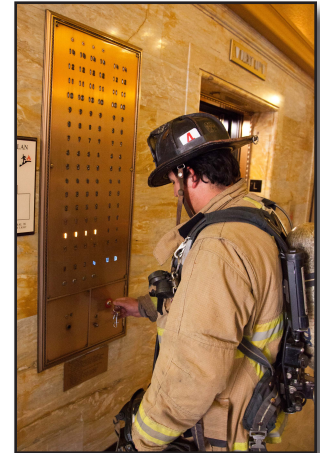

Figure 31-46 Phase I elevator operation occurs from the elevator lobby and is used to recall the elevator to the main floor

riding in been equipped with this feature. Phase II operation incorporates several features, [Figure 31-47](#).

The car only responds to inputs from within the car itself

Even if a person in the lobby or fire control room resets the elevator system, any car in Phase II will remain in that mode until the operator within the car returns it to normal operation.



Door open and close buttons require continuous pressure

When arriving at a floor the doors will not automatically open until you depress the open button; likewise the doors will not automatically close. If the open or close button is released prior to the doors being fully open or closed the doors will reverse direction. This is a key safety feature; if you open the door and are met with untenable conditions just let go of the button and the door will close.

However this feature can present a problem. If the operator lets go of the button and exits the car prior to the door being fully open the door will shut behind the operator and the car is now lost because it only responds to inputs from within. An elevator mechanic will be the only one who can retrieve the car. If there are no door open and door close buttons the floor selection button will serve this function.

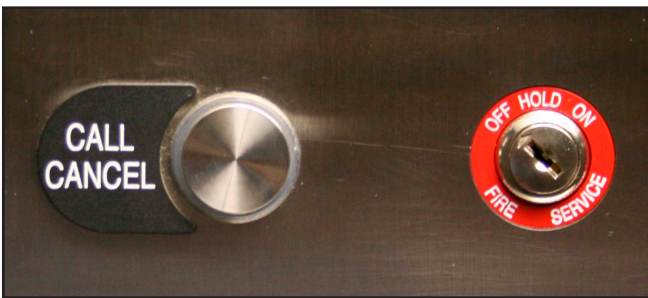

Call Cancel Button:

Any time the call cancel button is pressed, it will clear the input register and cause the car to stop at the nearest floor in the direction of travel.

Hold Feature

A keyway on the car interior firefighter control panel will be labeled “off”, “on”, and “hold.” To place the car in Phase II turn the key on. If you arrive at a floor and want to ensure no other firefighter comes along and takes your elevator you can place the key in the “hold” position and remove the key. In the “hold” position the register will not accept inputs.

If you ever get into an elevator car and note the key is in the “hold” position and you have an elevator key, stop and think. Another firefighter has obviously done this deliberately; do not take the car.

“Red Phone” Communications Jack

Elevator operators should obtain a red phone if available because portable radio communications may be spotty and could theoretically interfere

FIRE OPERATION

When flashes, exit elevator

To operate car	Insert fire key and turn to “ON” Press desired button.
To cancel floor selection	Press “CALL CANCEL” button.
To close power-operated door	Press and hold “DOOR CLOSE” button.
To open power-operated door	Press and hold “DOOR OPEN” button.
To hold car at floor	Turn key to “HOLD”.
To automatically send car to recall floor	With doors open, turn key to “OFF”.

Figure 31-47 Phase II elevator operation occurs from within the elevator car and must be activated by a key



with elevator computer control systems. Elevator operators shall carry their radio with them at all times.

Helmet Pictograph

On the control panel there will be a pictograph of a fire helmet, [Figure 31-48](#). When the elevator is in fire service operation the helmet will be illuminated. This visual alarm serves a very important purpose; it is connected to FAIDs in the elevator hoist-way and machine room, [Figure 31-49](#). Therefore if smoke or heat is present in a hoist-way or machine room the light will flash. It's critical that when this light flashes you immediately exit the elevator. The elevator is unsafe.

As previously mentioned water and elevators don't mix, so much so that elevator engineers installed a safety feature called "shunt trip" in elevator systems that have sprinklers in the machine room and hoist-way. The intent of the "shunt trip" is to disconnect power to the elevator upon activation of a heat sensor set at a lower temperature than the sprinklers are set to fuse at. This prevents an elevator in operation from having sprinklers discharge on it causing potentially dangerous elevator control problems.

So once the light flashes in an elevator equipped with a sprinkler equipped hoist-way or machine room you can anticipate the shunt trip to activate. The problem is you have no idea how fast the heat is evolving in the hoist-way or machine room so there is no way to know how long you have until power is removed from the car. When the power is removed, you're stuck wherever the car is. If the car stops greater than 18" from a landing zone it may be difficult or impossible to force the doors past the door restrictors.

The bottom line is that if the helmet is flashing, do not use the elevator. If the elevator is in use when the helmet is flashing, immediately depress "call cancel." This will cause the car to stop at the next floor in the direction of travel. You can then depress the "door open" and get out. Before getting in any elevator ensure you orient yourself to the stairwell for scenarios just like this. Egress from an elevator under low visibility conditions and knowing where the stairwell is may save your life.

Safe Firefighter Elevator Operations

Lobby Control will not have the ability to provide dedicated elevator operator-until more personnel are assigned to assist. This means the initial attack crews will ascend in the elevator without an operator. The dilemma then becomes how to return the elevator for others to use?

If you get to your destination and you no longer need the elevator simply turn the key inside the car to the "off" position and exit the car. The car has now reverted back to "Phase I" operation and will return to the pre-designated level and open its doors. Don't keep the key, leave it in the elevator. The next crew or operator will need it.



[Figure 31-48](#) When the fire helmet pictograph is flashing, do not use elevator.



[Figure 31-49](#) An activated Fire Alarm Initiating Device (FAID) inside of the elevator machine room will send the elevators into Automatic Phase I Recall - Do Not Use!



Phase I & II

Firefighters should only use Phase I and II equipped elevators during a high-rise fire incident. To determine if the elevators are Phase I and II equipped, look for the key slot in the main elevator lobby (or designated level) as well as a keyway and the words “firefighter operation” inside the elevator car itself.

If the elevators are in Automatic Phase I recall when you arrive, do not use them for initial attack. The elevators are telling you something is wrong with them and they returned to the designated level for precisely that reason. Remember that elevators only recall automatically when an FAID is initiated in an elevator lobby, hoist-way or machine room.

Firefighters should only use elevators for initial attack at fires above the 7th floor (risk vs. benefit). Before using an elevator you need to find out the lowest level of an alarm from the panel. Check the alarm panel and NEVER ride an elevator closer than 2 floors below the lowest level of the alarm. Taking the time to obtain this valuable information prior to using an elevator may save your life.

Banked Elevators

Banked elevators with a shaft termination within two floors of the floor of the alarm should not be used. Elevator machine rooms in a high-rise typically sit atop the hoist-way and can extend upwards of two floors above the uppermost floor that the elevator serves. Therefore, if a banked elevator terminates at the 10th floor, its machine room could extend as high as the 12th floor. A fire on the 11th or 12th floor could adversely affect elevator operations.

Ascending

Always stop at minimum every five floors when ascending. This will continuously allow you to ensure the car is acting appropriately to user inputs. Secondly, it gives you a chance to visually inspect the hoist-way. When stopped, open the doors and shine your light up into the hoist-way. If you note water and/or smoke do not use the elevator. Lastly, stopping every five floors allows you to get an idea of the floor layout and provides you with the opportunity to assess conditions.

Additionally, on the wall in the elevator lobbies is a crude floor plan placard that shows the stairwells in relation to that elevator lobby. Remove this map from the wall and keep it with you for reference and orientation.

Additional Safety Points

- Make sure you are familiar with elevator use prior to an emergency
- Ensure you utilize the elevator checklist, without exception. Your memory will fail you.
- Do not use blind shaft elevators. A blind elevator shaft spans one or more floors without a door opening. We only have a few of these in our city and they should not be used. If you get stuck there's no escaping.

Building Fire Pump Operations

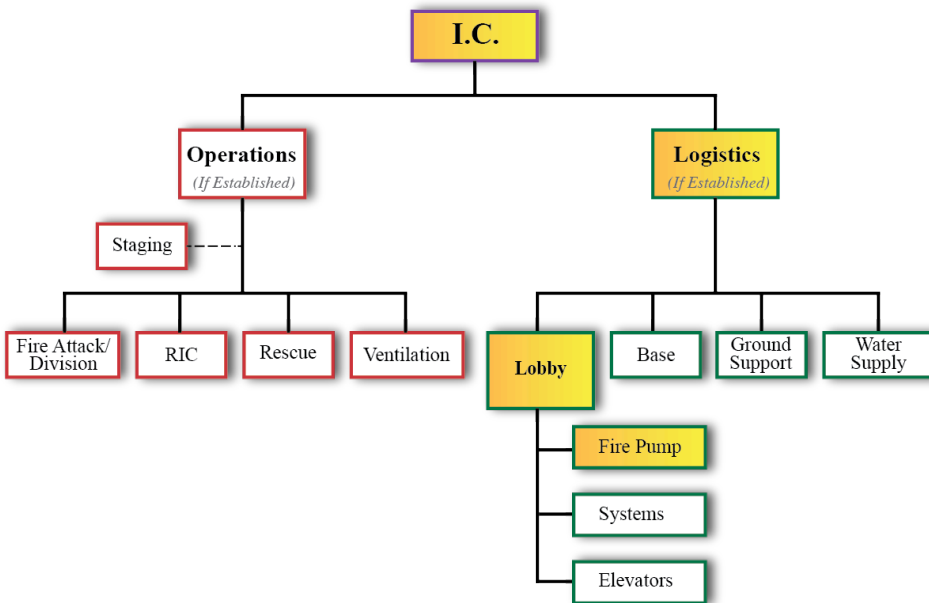

Primary Responsibilities

- Confer with Systems Control and observe status of fire pump if available
- Determine if pump is operating. It should be automatically activated.
- Monitor pressure gauges
- Troubleshoot any problems by
 - Checking valve positions
 - Control panel switches
 - Circuit breakers
 - Fuel level & air intake
- If pump is diesel powered, continually monitor fuel status

When called upon, the fire pump will typically turn on automatically and supply adequate pressure and water to the most remote outlets in a building. With that being said, upon initial arrival at a high-rise fire a firefighter working for Lobby Control should go to the fire pump room and ensure the pump is operating as expected and monitor the pump throughout the fire, [Figure 31-50](#). Fire pump operations fall under the control of Lobby Control, because in the initial phases of an incident Lobby Control is responsible for systems. As the incident grows a separate Systems Control Group or Systems Control Officer can be established.

Before leaving the lobby the firefighter should obtain a red phone or bring their

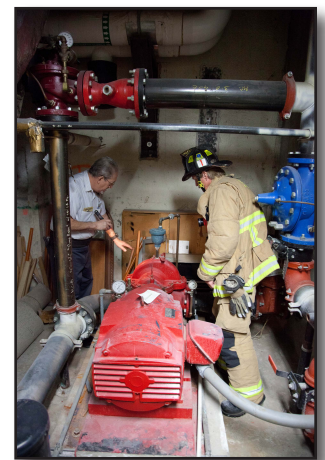

Figure 31-50 If possible, have a building engineer assist you with checking the proper function of the fire pump.



David Clark headset with them. Communications will be poor in the fire pump room, which is frequently in the basement as well as very noisy. Keys and forcible entry tools should be taken as well. If any delay is encountered in locating or accessing the fire pump, proper notification shall be made. Fire pumps in the tallest buildings may be in two places; the bottom floor and half-way up the building. Consult with the building engineer or floor plans for this information. (San Diego has very few buildings where the fire pump is located somewhere other than the basement).

Fire Pump Checks

Upon arrival in the fire pump room, firefighters shall ensure the pump is running and look at the pressure on the outlet side of the pump. Near this location there should be a placard giving the correct pump pressure, [Figure 31-51](#). If the pressure does not match the placard, make the appropriate notification.

If the pump is not running properly attempt to troubleshoot:

- Control panel switches
- Valve positions
- Circuit breakers
- Fuel level (monitor)
- Air intake

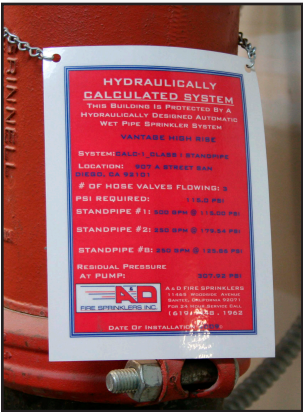

Figure 31-51 Check the pressure on the discharge side of the pump to ensure it matches the rated pressure on the placard (above 2 images)

As the incident progresses look for flooding in the area of the fire pump. If flooding is noted make immediate notification and develop a plan to prevent flooding, for example by checking the drain for blockage or obtaining submersible pumps. Keeping the fire pump running is a top priority.



Figure 31-52 A typical building fire pump



Water Supply

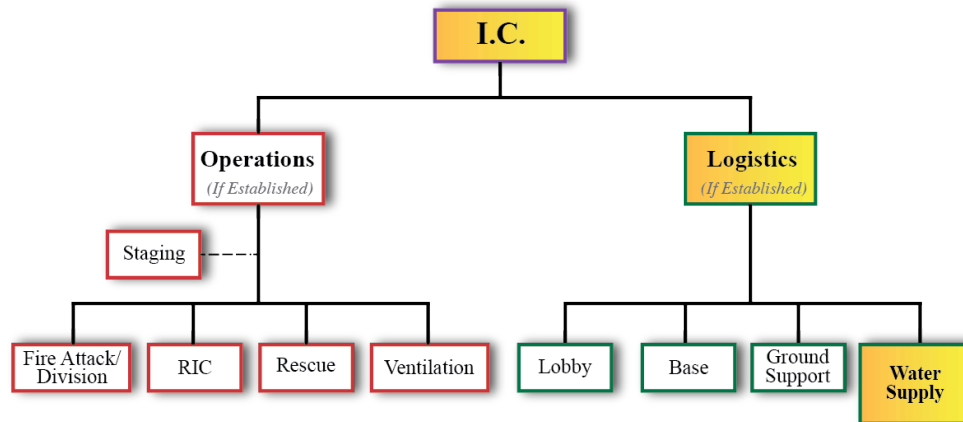

Primary Responsibilities

- Secure Water Supply
- Two pumps in series connected to FDC
- Position apparatus taking into consideration
 - FDC Location
 - Potential falling debris
- Provide initial pump pressure of 150 psi until status of fire pump is determined

The Water Supply Group is responsible for ensuring an adequate supply of water is delivered to the sprinkler/standpipe system. The first and second arriving engine companies should position themselves near the FDC in a manner that will facilitate pumping in series in order to generate the required high pressures. This positioning should also take into account the potential for falling debris which may damage hose lines and apparatus.





In the big picture, the fire apparatus are a back-up to the fixed high-rise fire-fighting system. The building should be able to deliver an adequate water supply at an appropriate pressure to every outlet in the building on its own. The fire apparatus are there as a back-up in case of system failures. As stated before, we should always anticipate failures because a building on fire is in a state of self-destruction.



Hose connections should be made to the FDC, [Figure 31-53](#). If using “high-pressure” hose, no shut-off butts should be used. High-pressure hose is blue or green in color and is used for buildings greater than 20 stories in height.

Pump Pressures

Initial pump pressure shall be 150psi until the status of the fire pump can be determined. If the fire pump is producing the required pressure, the pumpers can idle down in “standby” mode. If however the fire pump is inoperable or inadequate, the pumpers shall do one of two things:

- If the FDC is placarded with a recommended pump pressure, the operators shall pump that pressure.
- If no placard is present, utilize the standard formula:

$$PP=NP+SL (25) +FL+5 \text{ psi per floor.}$$

Ensure the work is split equally between the pumpers and monitor their performance including the need for re-fueling.

Safety Tips

Take proactive action to prevent injury or damage (ruptured lines) from falling debris. Suggestions include:

- Keep all but essential personnel out of the area affected by falling glass
- Lash hose-lines together and place ground ladders with salvage covers over them
- Cut street signs down and/or request plywood and place over the tops of apparatus parked next to each other creating a roof of sorts to stand under
- Develop a plan for catastrophic standpipe system failure. Solutions may be to lay hose up the stairwell or use an aerial as a standpipe. Plan ahead and expect failures.
- Read the water supply chapter of this manual for detailed information regarding sprinkler systems/standpipes and the unique features found at high-rises such as pressure reducing valves.

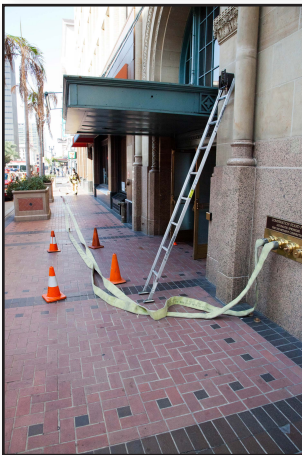
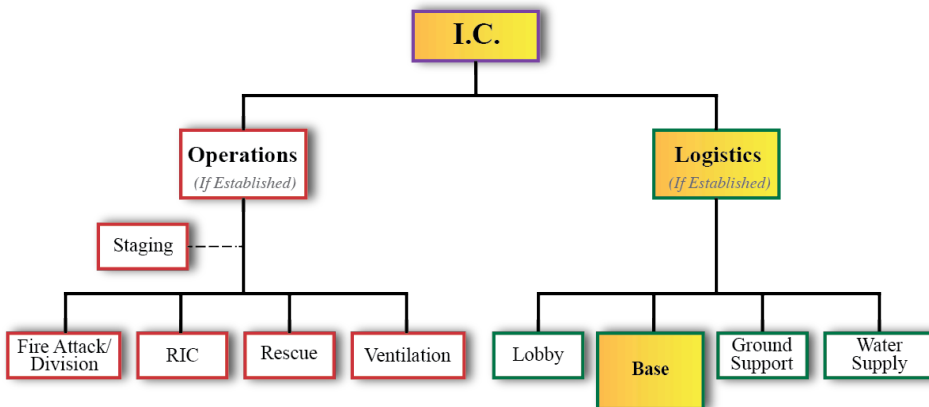

Figure 31-53 Connect a minimum of two supply lines to the FDC and set up two engine companies to pump in series.



Base



Primary Responsibilities

- Locate a suitable area for Base taking into account anticipated size & complexity of fire typically >200' to account for falling debris
- Coordinate with SDPD to establish secure parking & traffic plan
- Designate areas for people, gear, rigs etc.
- Implement crew check in/out process
- Build gear/equipment cache
- Determine resource levels to be maintained in Base

The function of Base is to provide an area remote from the building to organize firefighters and equipment prior to deployment into the working area. This function is essential to maintain organization and should be established at least 200 feet from the building. When selecting a site for Base consideration should be given to the following factors:

Traffic pattern/routing and the availability of safe and secure parking for apparatus. Work with SDPD to establish a security perimeter.

Attempt to select an area that has access to protection from the elements, has restrooms and lighting and is far enough away to avoid falling debris

Base Operations

Park apparatus at a 45 degree angle grouped together by type. Trucks should be parked closest to the incident.

Utilize banner tape to lend organization and create choke points. This will help to facilitate an orderly check in and checkout process of firefighters, supplies, and equipment. Accountability is essential.



Organize supplies and equipment and package for easy transport by the Ground Support Unit.

Designate an area for crews that are “on deck” and ensure they stay together and are prepared for immediate deployment.

Anticipate the need for food and drinking water.

Determine the required resource level to maintain in Base to support the objectives.



Ground Support

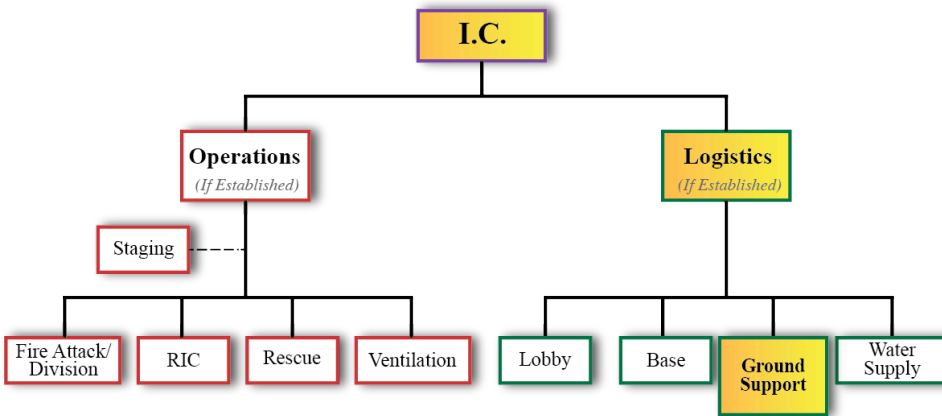

Primary Responsibilities

- Provide transportation of personnel & gear to staging either via the stairwells or elevator
- Implement safe ground level traffic plans for movement of personnel, supplies & motor vehicles
- Implement SCBA filling & exchange plan
- Provide fuel & servicing of all power equipment
- Develop a plan for laying hose & lighting in the event of catastrophic systems failures

The primary objective of Ground Support is to provide the supply chain for the firefighters fighting the fight. Ground Support transports gear, services equipment, and anticipates needed supplies and potential problems. An example would be anticipation of a power failure and the need to deploy lighting in the stairwells. Another function of Ground Support could be the deployment of hose up the stairs in anticipation of a catastrophic standpipe failure.

Ground Support reports directly to Logistics. Reporting to Ground Support are the Transport Manager, Apparatus and Equipment Manager, and the Air Supply Manager.

Transport Manager

The Transport Manager is responsible for getting fresh firefighters, equipment, and supplies from Base to Staging. This will require that safe routes are identified and marked as necessary. Remember falling debris can present a significant hazard. Once inside the building the ideal route of ascent will be the el-



evators. If that's not an option the labor-intensive task of moving firefighters, supplies and equipment up the stairs will have to be undertaken. Ideally, there will be one firefighter every 2 floors to create a "chain" up the stairs, with an Officer stationed every 5 floors to give direction and monitor firefighter safety. At the discretion of the Officer, firefighters engaged in the movement of material up the stairs who are not in an IDLH may dress down; however, they must keep their PPE/SCBA nearby. Avoiding heat exhaustion is essential to maintaining operational effectiveness.



The movement of SCBA bottles and drinking water to Staging is critical to incident success. Additionally, the Transport Manager will check with the Medical Unit to ensure an effective plan is in place to move injured firefighters down.

Lastly, the Transport Manager is responsible for developing a plan for general motor vehicle transport to support the incident. This could include securing a utility rig to shuttle equipment or personnel to and from the incident.

Apparatus and Equipment Manager

During prolonged incidents a plan will need to be developed for fueling and servicing apparatus and power equipment. This responsibility falls to the Apparatus and Equipment Manager. This may also include a mechanism to respond to unanticipated requests for support of apparatus and power equipment. Ensure adequate resources are requested and technical specialties are summoned to the scene (a mechanic with support vehicle for example).

Air Supply Manager

The Air Supply Manager is responsible for estimating the demand for SCBA bottles. This also includes coordinating a bottle exchange program with Transport to resupply Staging. Additional duties include setting up and operating refilling stations and light and air apparatus. An additional consideration is the possibility that mutual aid agencies may be using different types of SCBA bottles.



Summary

High-rise fire are complex and dangerous incidents. They pose unique challenges to fire departments because of the high hazards to life and property, the logistical difficulties, and advanced construction. The high-rise fire ground demands a strong command presence, preferably someone who is well versed in the tactics that may be required. In addition, all firefighters responding to a high-rise fire must have a good understanding of the many roles and responsibilities discussed in this chapter in order for all of the pieces to come together in a successful operation.

Because of the limited experience that most firefighters have with high-rise fires, continuous training is an essential element for success. As a company officer, take the time to drill and cover in depth all positions of the high-rise ICS incident. Having crew discussions, creating tactical pre-plans, and taking the opportunity to walk through the high-rises in your first in district to identify alarm panels, stairwells, FDC's will all help to prepare your crews for responding to a high-rise fire.





Media & Link Index



SDFD Video - Introduction to High-Rise Firefighting



SDFD Video - High-Rise ICS



SDFD Video - High-Rise Fire Attack



SDFD Video - High-Rise Lobby Control



SDFD Video - High-Rise Staging



SDFD Video - High-Rise Stairwells, Ventilation, and RAT



SDFD Video - High-Rise Standpipe Operations



SDFD Video - High-Rise Water Supply



SDFD Video - High-Rise Elevator Operations



One Meridian Plaza Technical Report, USFA



Cook County Fire Executive Summary



First Interstate Bank Building Fire Technical Report, USFA



Lasalle Bank Fire Publication



Positive Pressure Resource



SDFD High Rise Fire Envelope / Worksheet



References

1. SOP's from the following Fire Departments: FDNY, Chicago, San Francisco, Phoenix, Los Angeles, Sacramento
2. Fire Officer's Handbook of Tactics, Third Edition. John Norman. Fire Engineering, 2005.
3. High Rise Fire & Life Safety, OHagan, Publisher: Penwell 1977
4. Firefighting in High-Rise and Standpipe Equipped Buildings, McGrail, Publisher: Penwell 2007
5. Fundamentals of Building Construction Materials and Methods, Allen & Iano, Publisher: John Wiley & Sons 2009
6. Positive Pressure Attack for Ventilation & Firefighting, Garcia, Kauffmann, Schelble Publisher: Penwell 2006
7. Elevator and Escalator Rescue, Jarboe & O'Donoghue Publisher: Penwell
8. Elevators 101 2nd Edition, McCain Publisher Elevator World Inc. 2007
9. Building Construction for the Fire Service 3rd Edition, Brannigan, Publisher: NFPA 1992
10. NIST Wind Driven Fire Studies
http://www.nist.gov/el/windfire_031808.cfm
11. Positive Pressure Resource
www.positivepressureattack.com/
12. Curtis Massey/RAT Data
<http://www.disasterplanning.com/credentials/rapid-ascent-teams.html>
13. FEMA Operational Considerations for High-Rise Firefighting
www.usfa.fema.gov/downloads/pdf/publications/tr-082.pdf
14. High-Rise Building Fires, Hall, Publisher NFPA 2005
www.nfpa.org/assets/files/PDF/Research/HighRisefires.pdf
15. One Meridian Plaza Technical Report, USFA
<http://www.usfa.fema.gov/downloads/pdf/publications/tr-049.pdf>
16. Cook County Fire Executive Summary
<http://writer-tech.com/pages/ccab/CCAB%20Exec%20Summary%2093004%201550%205.0.pdf>



17. An Engineering View First Interstate Fire
http://www.nist.gov/customcf/get_pdf.cfm?pub_id=908807
18. First Interstate Bank Building Fire Technical Report, USFA
<http://www.usfa.fema.gov/downloads/pdf/publications/tr-022.pdf>
19. Lasalle Bank Fire Publication
<http://www.ideals.illinois.edu/bitstream/handle/2142/124/LaSalle%20Bank%20Fire,%202004pdf?sequence=2>
20. Clearwater Florida Multiple Fatality Condo Fire Technical Report, USFA
<http://www.usfa.fema.gov/downloads/pdf/publications/tr-148.pdf>
21. Incident Command For High-rise Operations, USDHS, 2006
<http://fire.state.nv.us/Files/Training/NFA%20Direct%20Delivery%20Courses/ICHO%20Student%20Manual.pdf>
22. High Rise Firefighting An Analysis Of Procedures For Operational Effectiveness, Edwards, NFA
<http://www.usfa.fema.gov/pdf/efop/efo36392.pdf>
23. Running Head: High Pressure Pumping Operations At High-Rise Fires, Savelle, New Orleans FD
<http://www.usfa.fema.gov/pdf/efop/efo41482.pdf>

Credits

Writers:

Kurtis Benentt

Layout & Editing:

Kurtis Bennet, John Brubaker

Media:

Kurtis Bennet, John Brubaker

Grammatical Editing:

Lee Swanson

NOTE: If you have any additional information or content that you feel would be appropriate to contribute to this Chapter or would like to report any errors or misrepresentations, please contact the SDFD Training Division or email the Drill Manual Revision Staff at

SDFDDrillManualTeam@SanDiego.gov



Revisions/Updates

<i>Date</i>	<i>Revision/Update Description</i>
12/2018	Added Standpipe Kit Inventory & In-Line Pressure Gauge Instructions
2/2023	Updated GPM numbers on page 31-16. New numbers have been rounded to the nearest 10 to comply with Bulletin 20-01 “rounding of handheld smooth bore nozzles shall be rounded to the nearest 10 GPM”